

# ATF 600G-8

600 TON MAX. LIFTING CAPACITY

EUROMOT 4

# ALL TERRAIN CRANE



**PRELIMINARY**

**2 ENGINES**

# Table of contents · Inhaltsverzeichnis · Table des matières Índice · Sommario · Оглавление

## General · Allgemein · Généralités · Generalidades · Generalità · Общие положения

Boom systems · Auslegersysteme · Systèmes de flèche · Sistema de pluma · Sistemi di bracci · Конфигурации стрелы 4 - 5

Vehicle dimensions · Fahrzeugabmessungen · Dimensions du véhicule · Dimensiones del vehículo  
Dimensioni veicolo · Габариты машины 6

## On-road and off-road driving · Straßen- und Geländefahrt · Marche route et tout terrain Traslado por carretera y todoterreno · Marcia su strada e fuori strada · Движение по дорогам и бездорожью

Axle loads · Achslasten · Charges par essieu · Cargas por eje · Carichi assiali · Нагрузка на ось 8

Speeds and gradeability · Geschwindigkeiten und Steigfähigkeit · Vitesses de conduite et gravissement de pente  
Velocidades y pendientes superables · Velocità e pendenza · Скорость и грузоподъемность 8

Steering · Lenkung · Direction · Dirección · Sterzo · Рулевое управление 8

## Transport · Transporte · Trasporto · Транспортировка

Counterweight · Gegengewicht · Contrepoids · Contrapeso · Contrappeso · Противовес 10 - 11

Carrier counterweight · Gegengewichtsträger · Porte-contrepoids  
Depósito del contrapeso · Supporto contrappeso · Держатель противовеса 11

Jibs · Spitzen · Fléchettes · Plumines · Punte · гусек 12 - 16

Hose drum for hydraulic jib · Schlauchtrommel für hydraulische Spitze · Tambour de flexible pour fléchette hydraulique  
Devanadera para plumín hidráulico · Aspo raccoglitorbo per punta idraulica · Барабан для намотки шланга для гидравлического гуська 17

Outriggers · Abstützung · Calage · Estabilizadores · Stabilizzazione · На аутригерах 17

## Operation · Einsatz · Utilisation · Uso · Эксплуатация

Main boom · Hauptausleger · Flèche principale · Pluma principal · Braccio principale · Главная стрела 20

Swing mechanism · Drehwerk · Groupe de rotation · Mecanismo de giro · Gruppo di rotazione · Поворотный механизм 20

Winches · Hubwinden · Treuils · Cabrestantes · Argani · Лебедки 20

Hook blocks · Unterflaschen · Mouflas · Pastecas de carga · Bozzelli · Крюковые обоймы 20

Working ranges and lifting capacities · Arbeitsbereiche und Traglasten · Rayons de travail et charges de levage  
Áreas de trabajo y cargas · Aree di lavoro e portate · Рабочие зоны и грузоподъемность 22 - 48

## Additional information · Zusatzinformationen · Informations supplémentaires Información adicional · Altre informazioni · Дополнительная информация

Remarks · Anmerkungen · Remarques · Notas · Annotazioni · Примечания 50 - 51

Symbols · Symbolerklärung · Glossaire des symboles · Glosario de simbolos  
Spiegazione dei simboli · Условные обозначения 52

# GENERAL TECHNICAL DATA

ALLGEMEINE TECHNISCHE DATEN

CARACTÉRISTIQUES TECHNIQUES GÉNÉRALES

DATOS TÉCNICOS GENERALES

DATI TECNICI GENERALI

ОБЩИЕ ТЕХНИЧЕСКИЕ ХАРАКТЕРИСТИКИ



General · Allgemein · Généralités  
 Generalidades · Generalità · Общие положения

Boom systems · Auslegersysteme · Systèmes de flèche  
 Sistema de pluma · Sistemi di bracci · Конфигурации стрелы

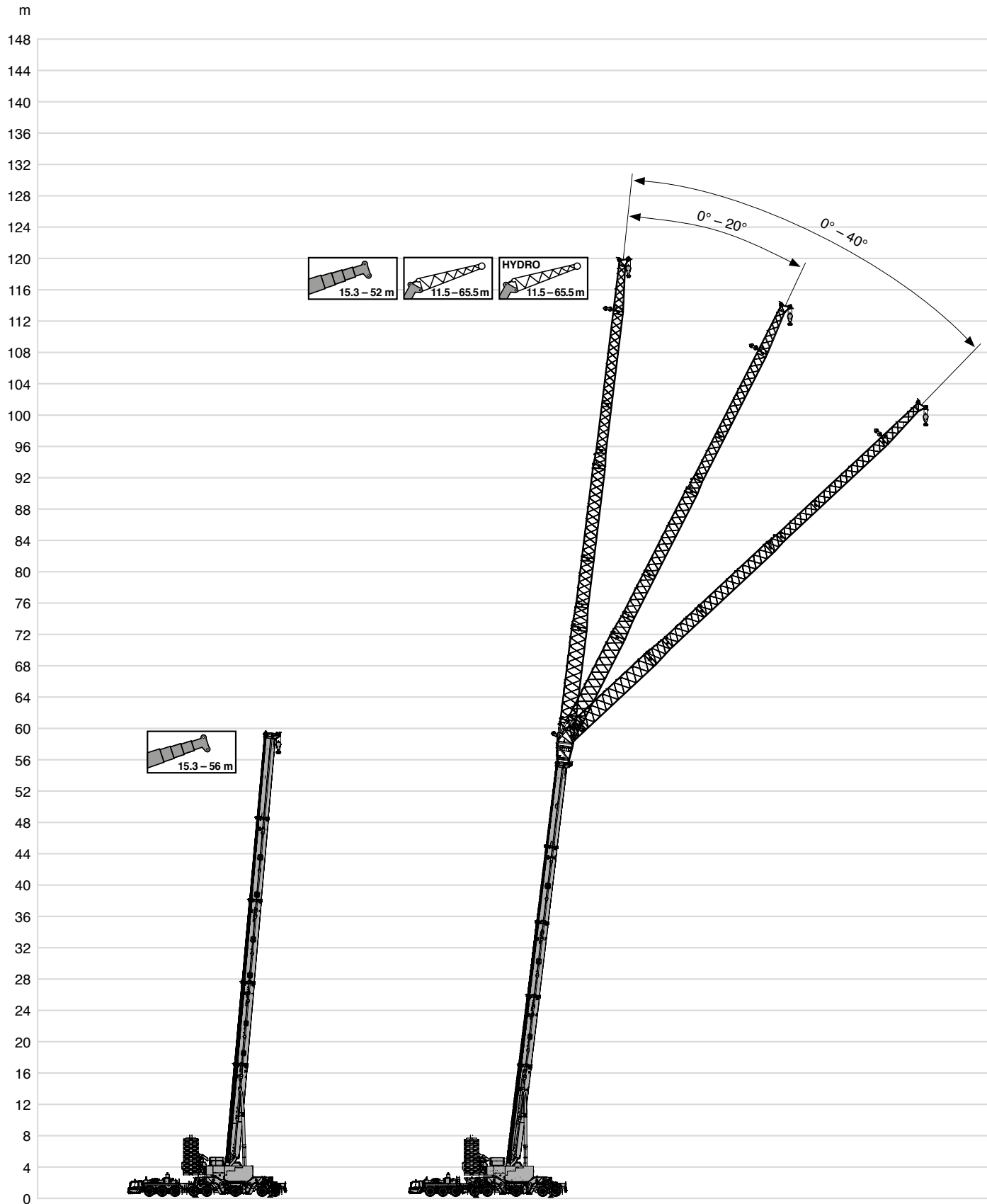

m  
148  
144  
140  
136  
132  
128  
124  
120  
116  
112  
108  
104  
100  
96  
92  
88  
84  
80  
76  
72  
68  
64  
60  
56  
52  
48  
44  
40  
36  
32  
28  
24  
20  
16  
12  
8  
4  
0

15.3 - 52 m  
28.1 - 94.1 m

8° - 63°

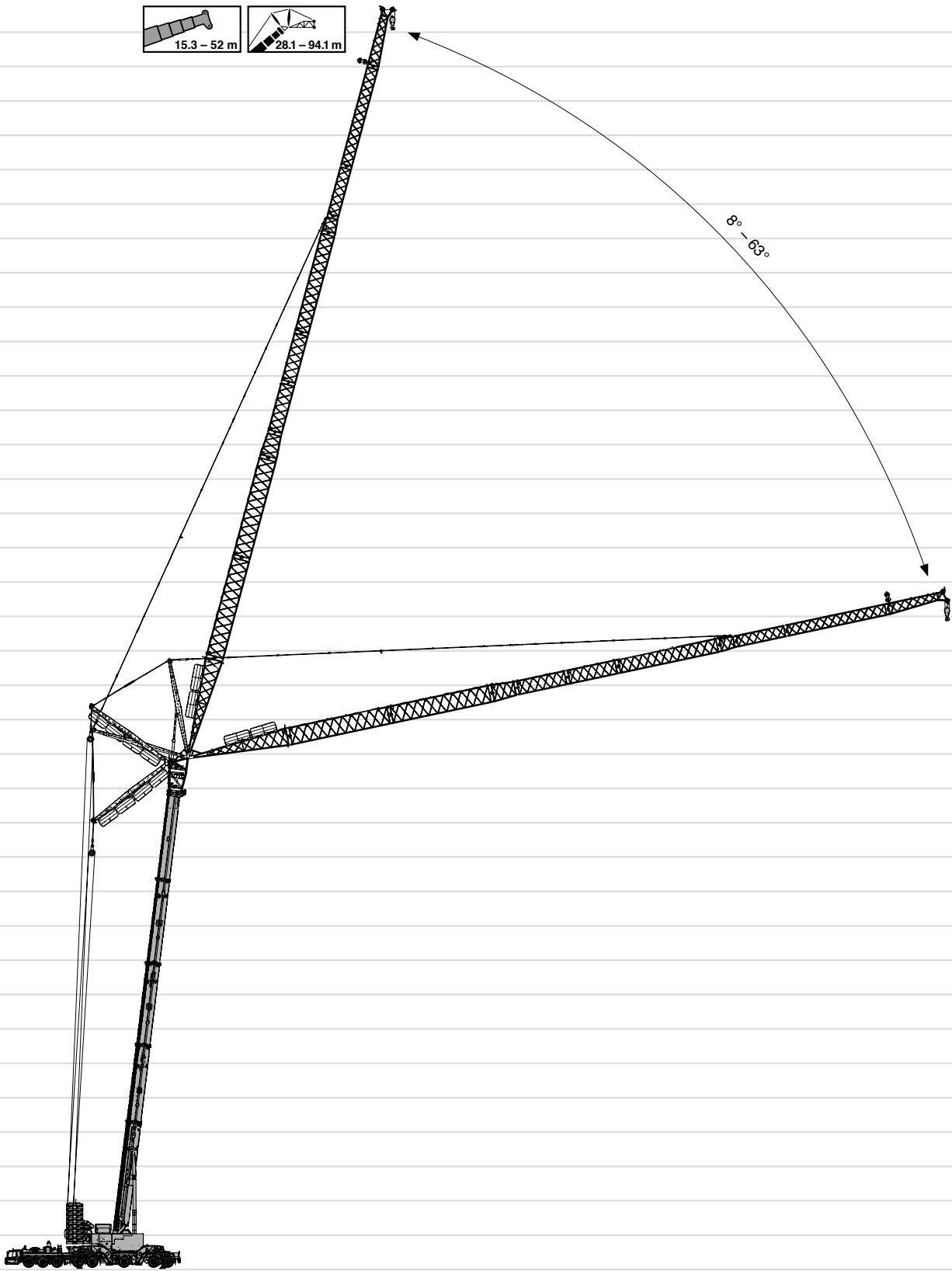

General · Allgemein · Généralités  
 Generalidades · Generalità · Общие положения

Vehicle dimensions · Fahrzeugabmessungen · Dimensions du véhicule  
 Dimensiones del vehículo · Dimensioni veicolo · Габариты машины

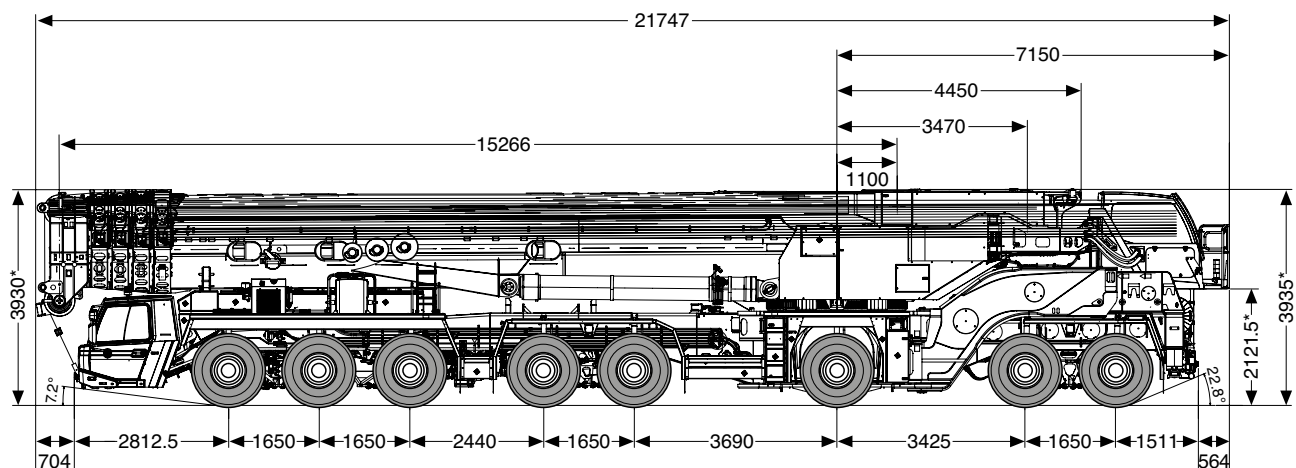

\* + 158  
 - 118

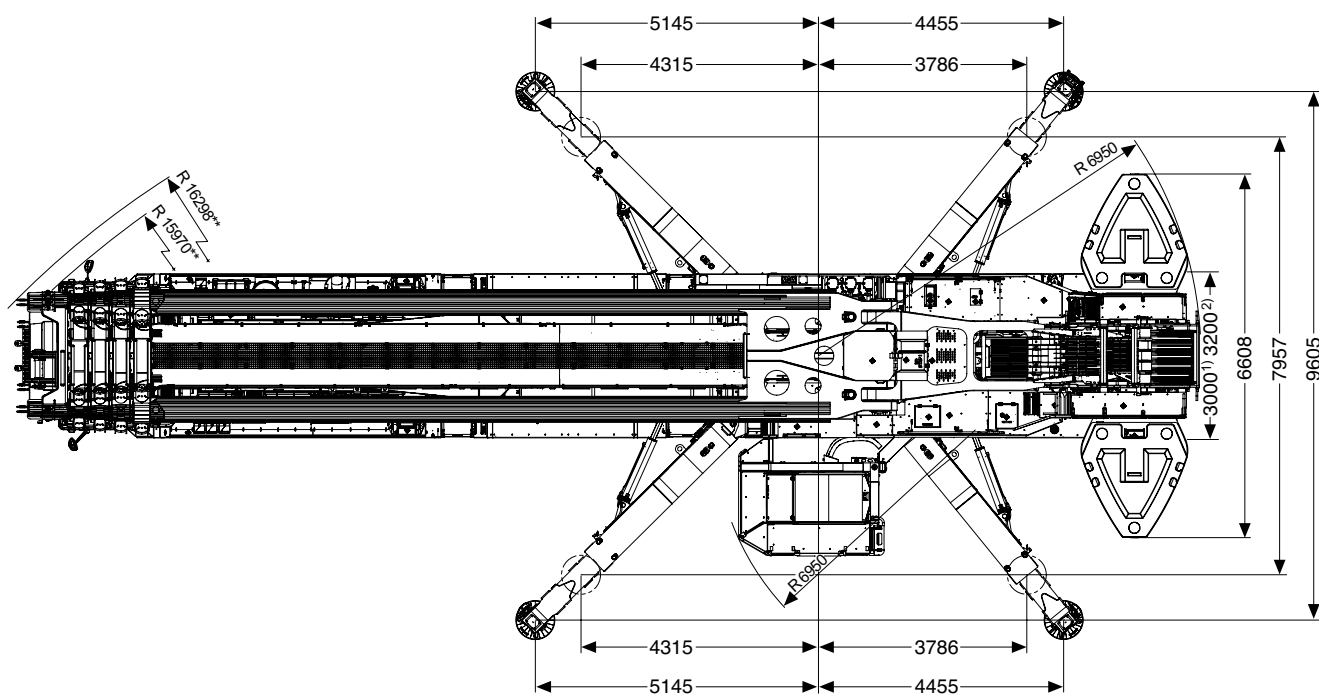

\*\* Minimum · minimum · mínimo · minimo · мінімальны

- 1) 385/95 R 25 (14.00 R 25)
- 2) 445/95 R 25 (16.00 R 25)
- 525/80 R 25 (20.5 R 25)

# TECHNICAL DATA FOR ON-ROAD AND OFF-ROAD DRIVING

TECHNISCHE DATEN FÜR DIE STRASSEN- UND GELÄNDEFAHRT  
CARACTÉRISTIQUES TECHNIQUES POUR MARCHE ROUTE ET TOUT TERRAIN

DATOS TÉCNICOS PARA SU TRASLADO POR CARRETERA Y TODO TERRENO



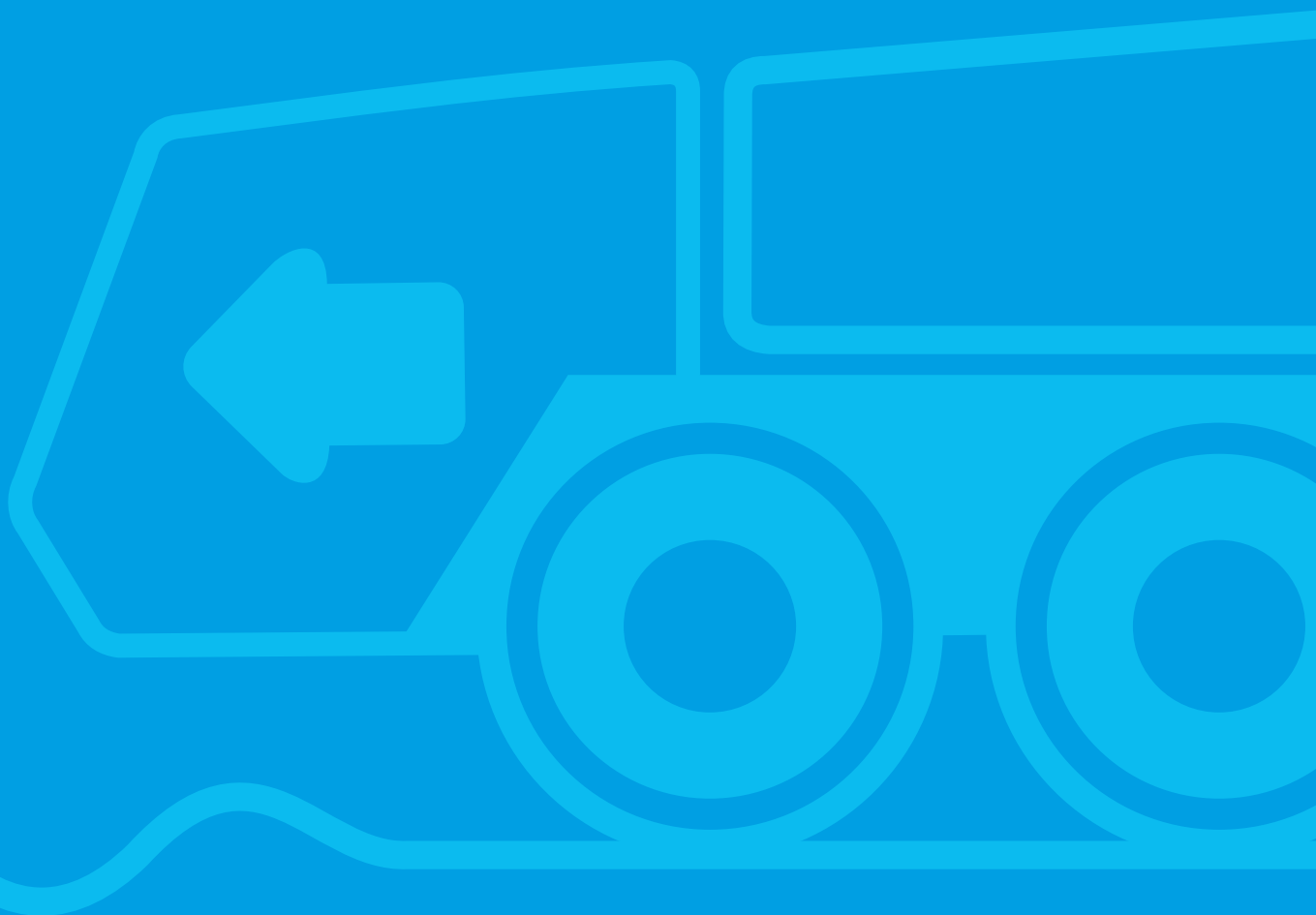

DATI TECNICI PER MARCIA SU STRADA E FUORI STRADA

ТЕХНИЧЕСКИЕ ХАРАКТЕРИСТИКИ ПРИ ДВИЖЕНИИ ПО ДОРОГАМ И БЕЗДОРОЖЬЮ



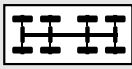

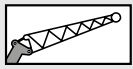

On-road and off-road driving · Straßen- und Geländefahrt · Marche route et tout terrain  
 Traslado por carretera y todoterreno · Marcia su strada e fuori strada  
 Движение по дорогам и бездорожью

Axle loads · Achslasten · Charges par essieu  
 Cargas por eje · Carichi assiali · Нагрузка на ось



	TOTAL			TYPE		
≤ 12 t	96.0 t***	16 x 8	385/95 R 25	-	-	0 t
≤ 16.5 t	103.5 t****	16 x 8	385/95 R 25	-	-	0 t
max **	243.5 t	16 x 8	385/95 R 25	50	-	140.0 t

\* Axle loads vary depending on equipment mounted. Individual calculation available on demand. · Achslasten variieren je nach Ausrüstungsumfang. Individuelle Berechnung auf Anfrage.  
 Las cargas por ejes pueden variar según el equipamiento. Cálculo individual sobre pedido. · Les charges par essieux peuvent varier en fonction de l'équipement monté. Calcul individuel sur demande.  
 I carichi degli assi variano in base all'entità dell'equipaggiamento. Calcolo individuale su richiesta. · Нагрузка на ось зависит от установленного оборудования. Индивидуальный расчет по запросу.  
 \*\* Construction site · Baustelle · Chantier de construction · Obra · Cantiere · стройплощадка  
 \*\*\* Front outriggers removed · Vordere Abstützung demontiert · Outrigger AV démonté · Estabilizadores delanteros desmontados · Stabilizzazione anteriore smontata · передние аутриажеры демонтированы  
 \*\*\*\* With front and rear outriggers · Mit vorderer und hinterer Abstützung · Avec outriggers AV et AR · Con estabilizadores delanteros y traseros · Con stabilizzazione anteriore e posteriore  
 с передними и задними аутриажерами

Speeds and gradeability · Geschwindigkeiten und Steigfähigkeit · Vitesses de conduite et gravisement de pente  
 Velocidades y pendientes superables · Velocità e pendenza · Скорость и грузоподъемность

	 	 
385/95 R 25	85 km/h max.	46.3 %
445/95 R 25	85 km/h max.	41.7 %

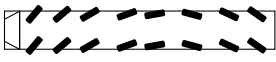
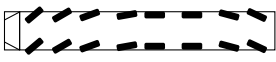
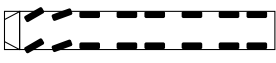
Steering · Lenkung · Direction  
 Dirección · Sterzo · Рулевое управление

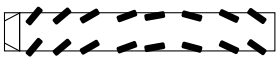
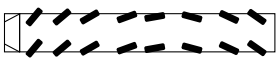
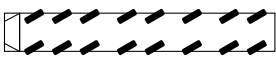
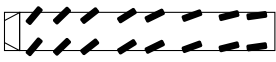
	 v < 25 km/h
	 v ≥ 25 km/h
	 v > 50 km/h
	 Manual steering · Manuelle Lenkung · Direction manuelle Dirección manual · Sterzo manuale · Ручное управление
	 Smallest turning circle · Kleinster Wendekreis · Rayon de braquage mini. Mínimo radio · Raggio di sterzata minimo · Минимальный радиус поворота
	 Diagonal steering · Hundegang · Marche en crabe Marcha cangrejo · Sterzata carrello · Движение по диагонали
	 Rear veering suppression · Heck-Ausscher-Unterdrückung Suppression de déboîtement AR · Supresión de movimiento transversal de parte posterior Soppressione oscillazione coda veicolo · Компенсация выноса задней части крана



# TECHNICAL DATA FOR TRANSPORT

TECHNISCHE DATEN FÜR DEN TRANSPORT  
CARACTÉRISTIQUES TECHNIQUES POUR LE TRANSPORT  
DATOS TÉCNICOS PARA EL TRANSPORTE  
DATI TECNICI PER IL TRASPORTO  
ТЕХНИЧЕСКИЕ ДАННЫЕ ДЛЯ ТРАНСПОРТИРОВКИ



Transport · Transporte  
 Trasporto · Транспортировка

Counterweight · Gegengewicht · Contrepoids  
 Contrapeso · Contrappeso · Противовес

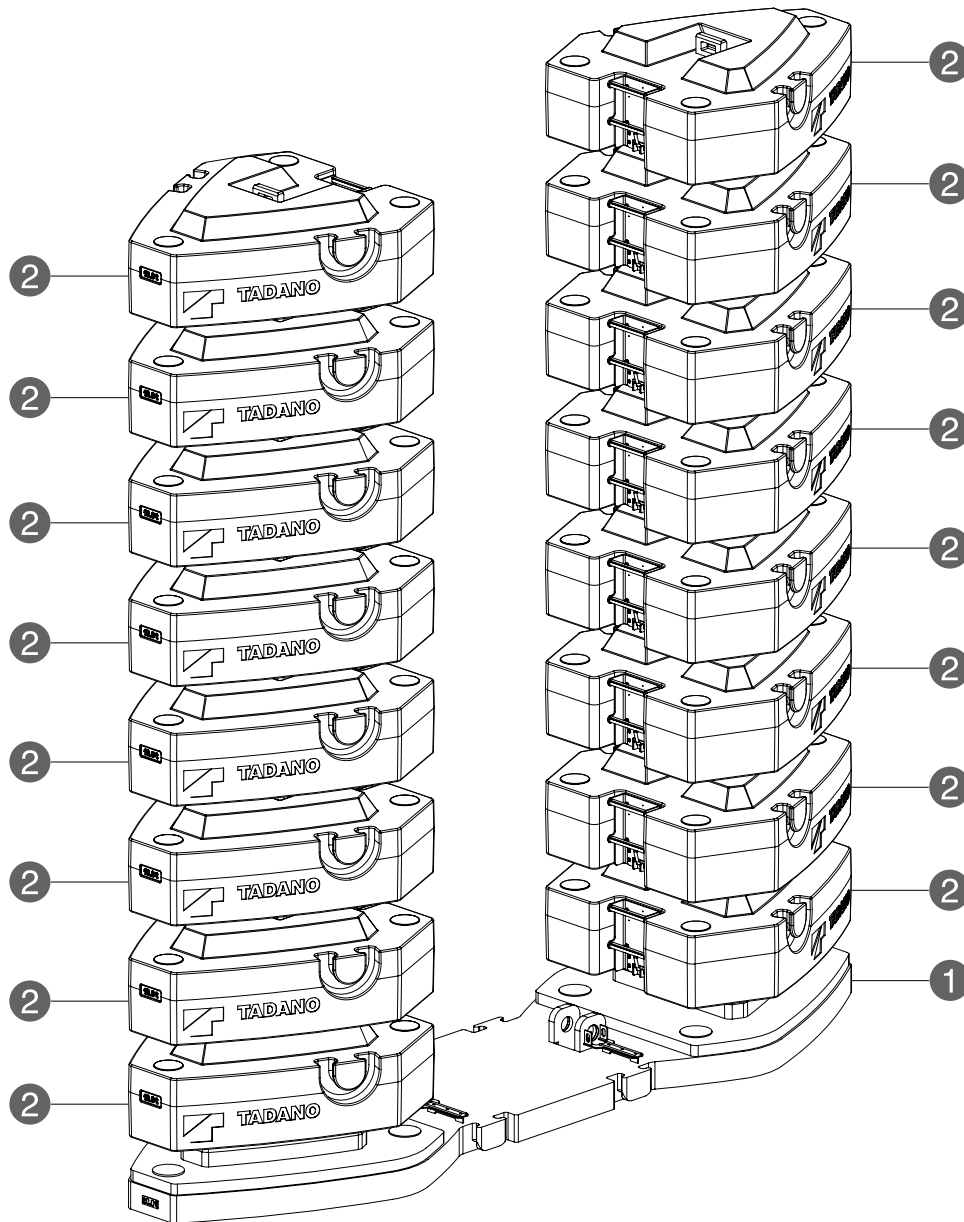

		20 t	40 t	60 t	80 t	100 t	120 t	140 t	160 t	180 t
①	20.0 t	1	1	1	1	1	1	1	1	1
②	10.0 t	-	2	4	6	8	10	12	14	16

1

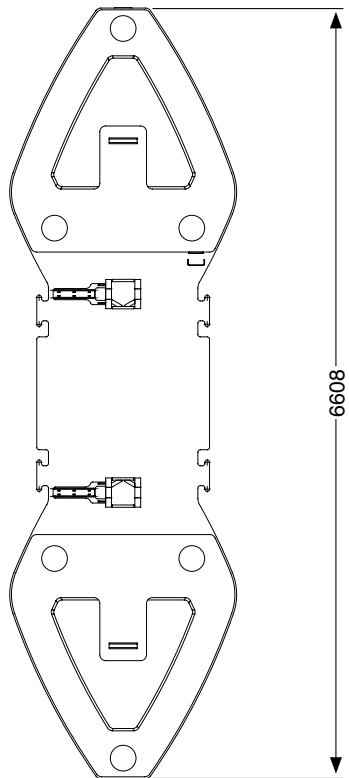
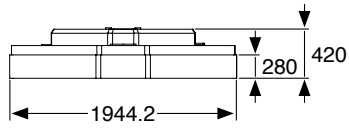

2

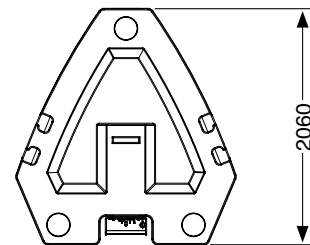
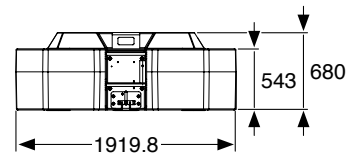

Carrier counterweight · Gegengewichtsträger · Porte-contrepoids  
 Depósito del contrapeso · Supporto contrappeso · Держатель противовеса



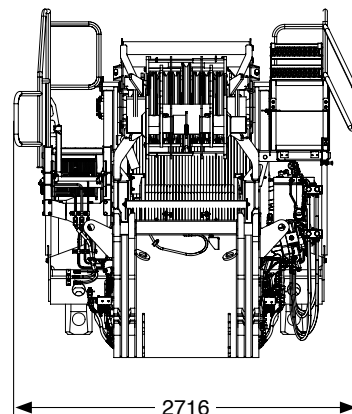
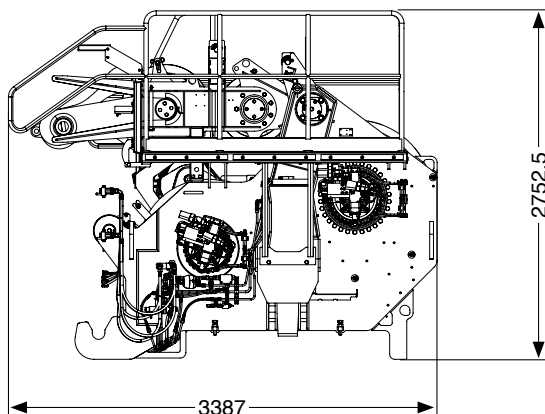

14263\*



\* with 2<sup>nd</sup> and 3<sup>rd</sup> winch, setup winch and pulley carrier · mit 2. und 3. Winde, Rüstwinde und Rollenträger · avec 2ème et 3ème treuil, treuil de montage et porte-poulie  
 con 2° y 3° cabrestante, cabrestante de montaje y portapoleas · con 2° e 3° argano, argano di riserva e portarullo · со 2-й и 3-й лебёдками, монтажной лебёдкой и держателем роликов

Transport · Transporte  
 Trasporto · Транспортировка

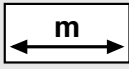
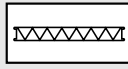
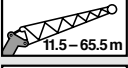
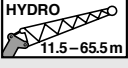
Jibs · Spitzen · Fléchettes  
 Plumines · Punte · гусек

		
 11.5 – 65.5 m  11.5 – 65.5 m	3 m + 8.5 m	① + ⑬ + ⑤ + ⑧ + ⑫
	3 m + 14.5 m	① + ⑬ + ⑤ + ⑧ + ⑪
	3 m + 20.5 m	① + ⑬ + ⑤ + ⑥ + ⑧ + ⑪
	3 m + 26.5 m	① + ⑬ + ③ + ⑤ + ⑧ + ⑪
	3 m + 32.5 m	① + ⑬ + ③ + ⑤ + ⑥ + ⑧ + ⑪
	3 m + 38.5 m	① + ⑬ + ③ + ⑤ + ⑦ + ⑧ + ⑪
	3 m + 44.5 m	① + ⑬ + ③ + ⑤ + ⑥ + ⑦ + ⑧ + ⑪
	3 m + 50.5 m	① + ⑬ + ③ + ⑤ + ⑥ + ⑦ + ⑧ + ⑨ + ⑪
	3 m + 56.5 m	① + ⑬ + ③ + ⑤ + ⑥ + ⑦ + ⑧ + ⑩ + ⑪
3 m + 62.5 m	① + ⑬ + ③ + ⑤ + ⑥ + ⑦ + ⑧ + ⑨ + ⑩ + ⑪	
 28.1 – 94.1 m	4.1 m + 24 m	① + ② + ⑤ + ⑥ + ⑧ + ⑫
	4.1 m + 30 m	① + ② + ③ + ⑤ + ⑧ + ⑫
	4.1 m + 36 m	① + ② + ③ + ⑤ + ⑥ + ⑧ + ⑫
	4.1 m + 42 m	① + ② + ③ + ⑤ + ⑦ + ⑧ + ⑫
	4.1 m + 48 m	① + ② + ③ + ⑤ + ⑦ + ⑧ + ⑪
	4.1 m + 54 m	① + ② + ③ + ④ + ⑤ + ⑥ + ⑧ + ⑪
	4.1 m + 60 m	① + ② + ③ + ④ + ⑤ + ⑦ + ⑧ + ⑪
	4.1 m + 66 m	① + ② + ③ + ④ + ⑤ + ⑥ + ⑦ + ⑧ + ⑪
	4.1 m + 72 m	① + ② + ③ + ④ + ⑤ + ⑥ + ⑦ + ⑧ + ⑨ + ⑪
	4.1 m + 78 m	① + ② + ③ + ④ + ⑤ + ⑥ + ⑥ + ⑦ + ⑧ + ⑨ + ⑪
	4.1 m + 84 m	① + ② + ③ + ④ + ⑤ + ⑥ + ⑥ + ⑦ + ⑧ + ⑩ + ⑪
	4.1 m + 90 m	① + ② + ③ + ④ + ⑤ + ⑥ + ⑥ + ⑦ + ⑧ + ⑨ + ⑩ + ⑪

1   
1564



2   
10700

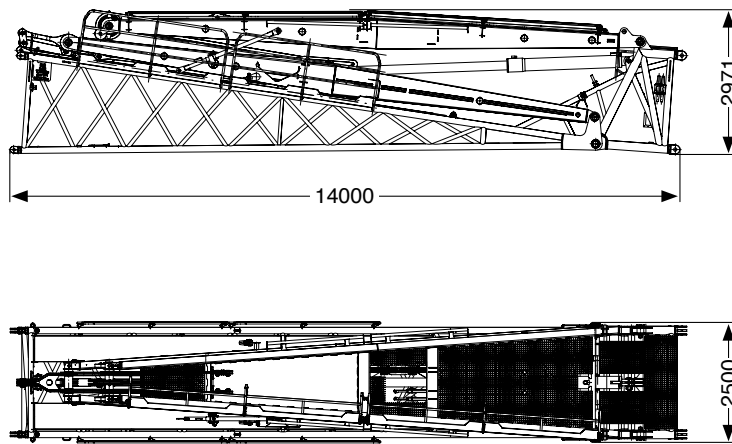

3   
2765

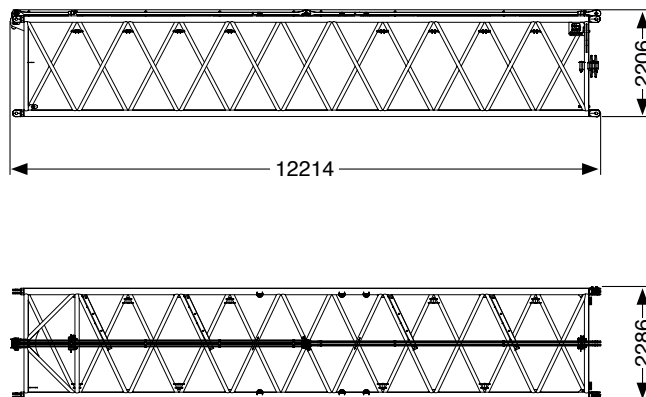

4   
2758

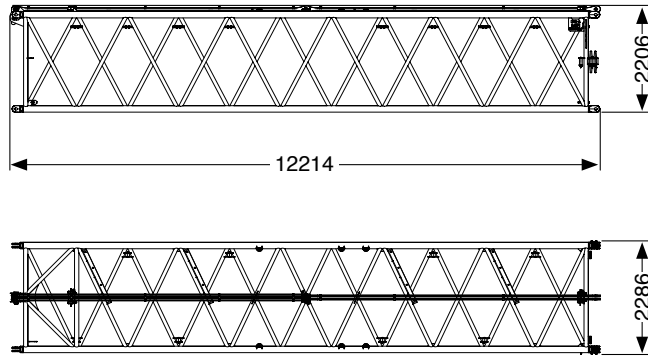

5   
923



6   
1207

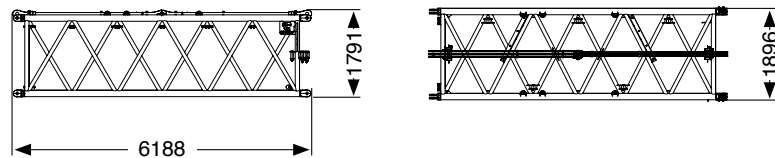

7   
2124

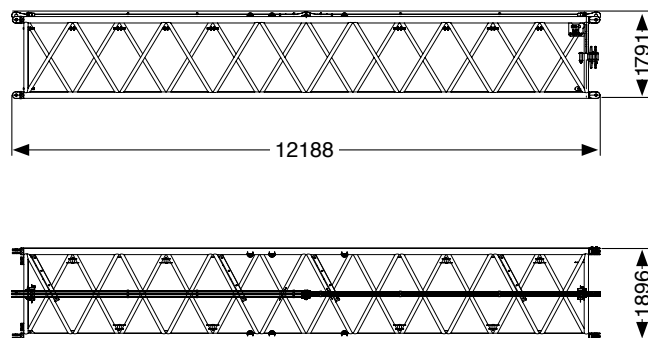

8   
972



9   
1076

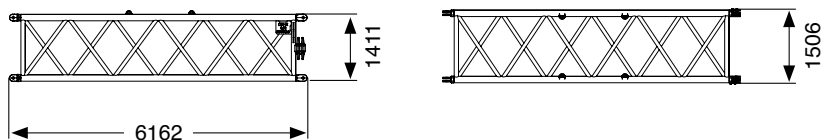

10   
1609

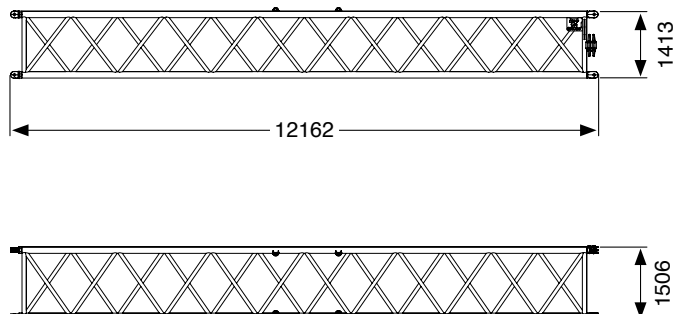

11   
1500

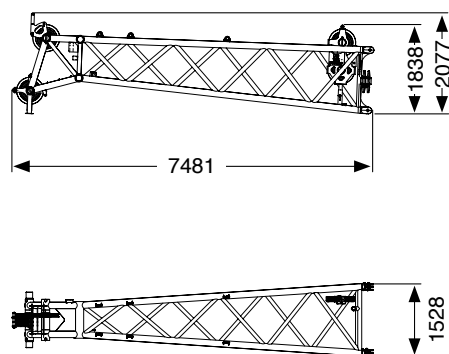

12   
1212

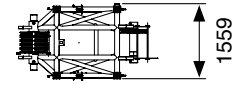
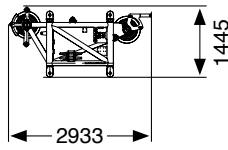

13   
2711

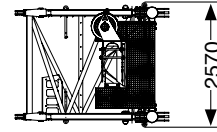
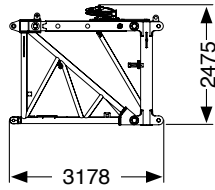

3 + 6 + 6 + 9   
6261

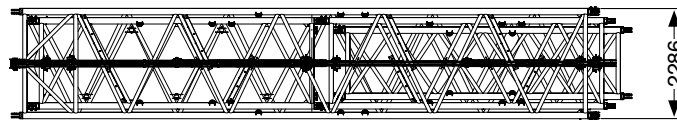
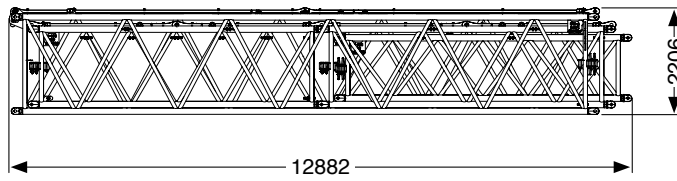

4 + 7 + 10   
6322

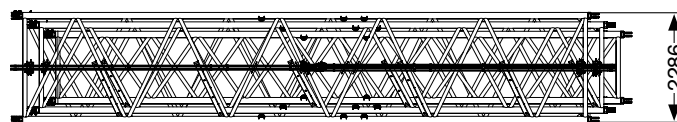
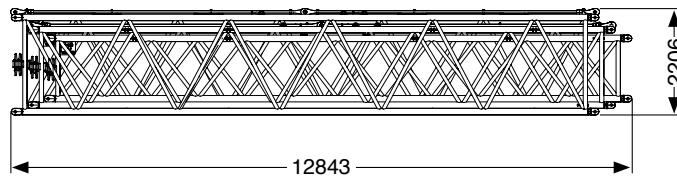

  
430

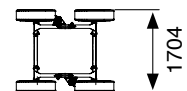
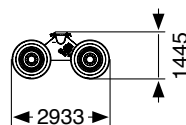



Hose drum for hydraulic jib · Schlauchtrommel für hydraulische Spitze · Tambour de flexible pour fléchette hydraulique  
Devanadera para plumín hidráulico · Aspo raccoglitrubo per punta idraulica · Барабан для намотки шланга для гидравлического гуська



352

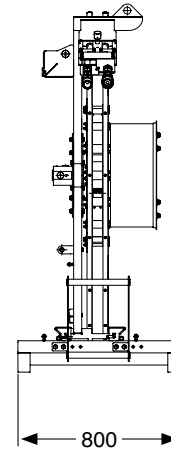
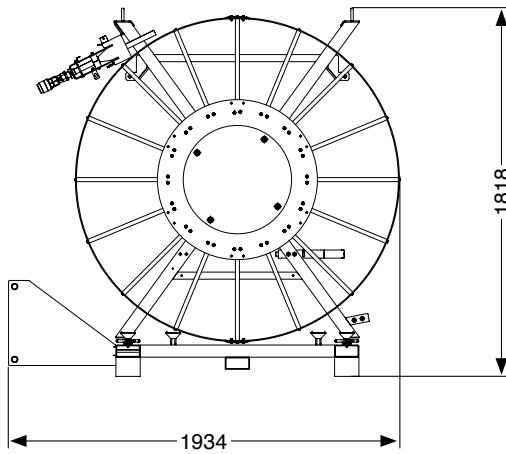

Outriggers · Abstützung · Calage  
Estabilizadores · Stabilizzazione · На аутригерах



4030

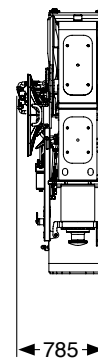
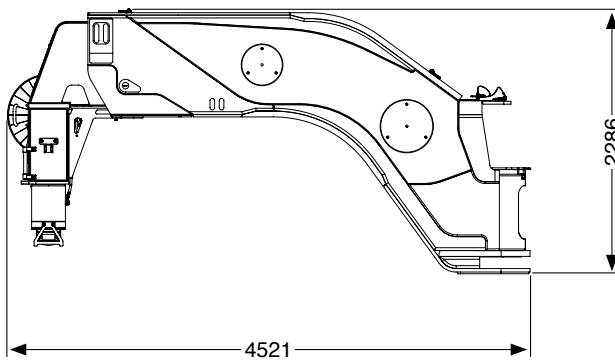

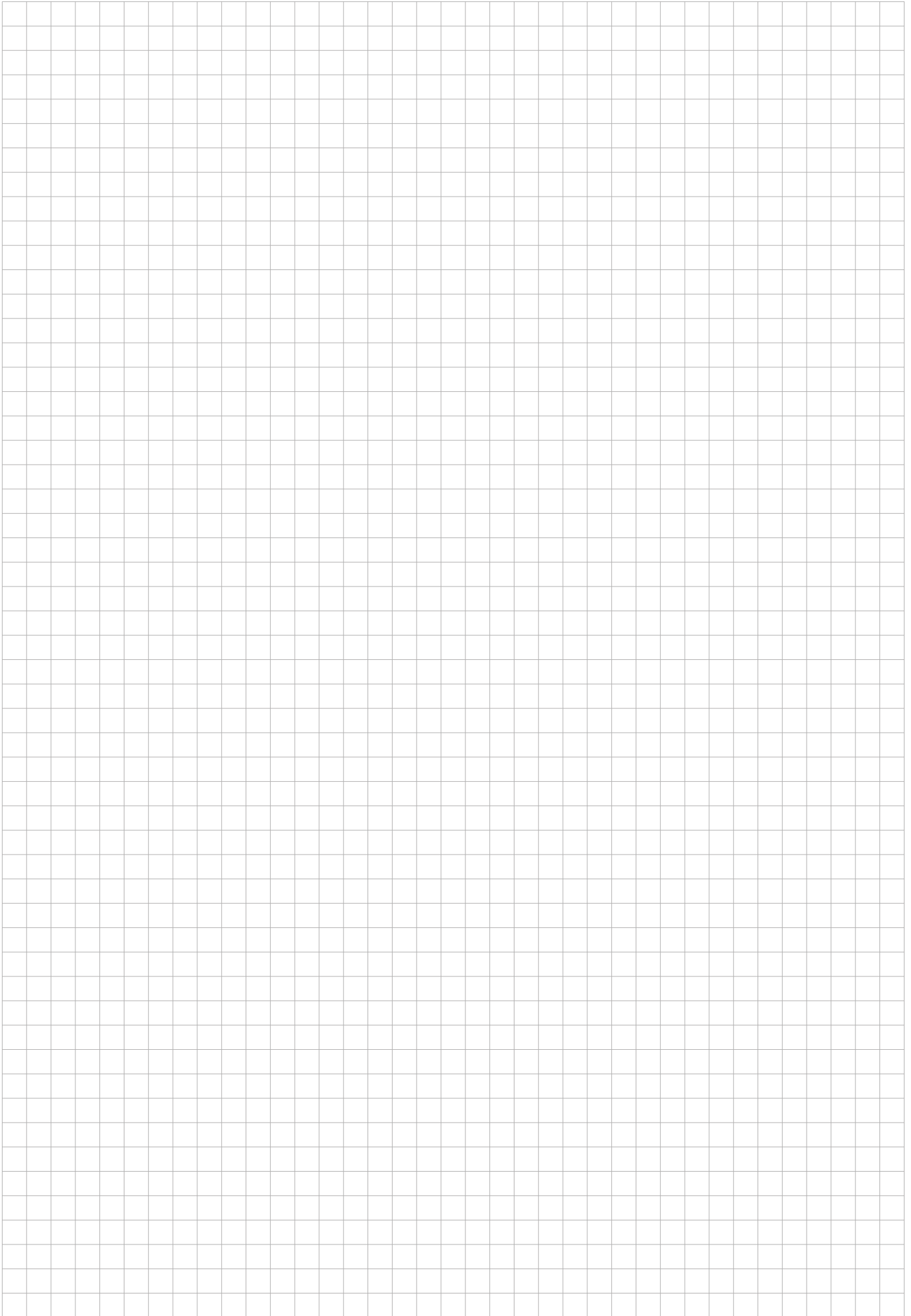

# TECHNICAL DATA FOR OPERATION

TECHNISCHE DATEN FÜR DEN EINSATZ

CARACTÉRISTIQUES TECHNIQUES POUR L'UTILISATION

DATOS TÉCNICOS PARA EL USO

DATI TECNICI PER L'USO

ТЕХНИЧЕСКИЕ ЭКСПЛУАТАЦИОННЫЕ ХАРАКТЕРИСТИКИ



Operation · Einsatz · Utilisation  
 Uso · Эксплуатация







Main boom · Hauptausleger · Flèche principale  
 Pluma principal · Braccio principale · Главная стрела

	- 1.3° – 85°	~ 75 s
	15.3 m – 56 m	~ 700 s





Swing mechanism · Drehwerk · Groupe de rotation  
 Mecanismo de giro · Gruppo di rotazione · Поворотный механизм

	0 – 1.2 min <sup>-1</sup>		0° / 180°
---	---------------------------	---	-----------

Winches · Hubwinden · Treuils  
 Cabrestantes · Argani · Лебедка

			
	0 – 115 m/min	23 mm / 580 m	141
	0 – 115 m/min	23 mm / 1045 m	141
	0 – 115 m/min	23 mm / 580 m	141

Hook blocks · Unterflaschen · Moufles  
 Pastecas de carga · Bozzelli · Крюковые обоймы

 TYPE				
400*	355.1	13	27	4000
250*	250	9	19	2700
200*	200	7	15	2300
160*	151.6	5	11	2000
100*	97.6	3	7	1800
50	42.3	1	3	1300
16	14.3	0	1	500

\* Twin hook · Doppelhaken · Moufle avec crochet marin · Gancho doble · Gancio doppio · Двойной крюк

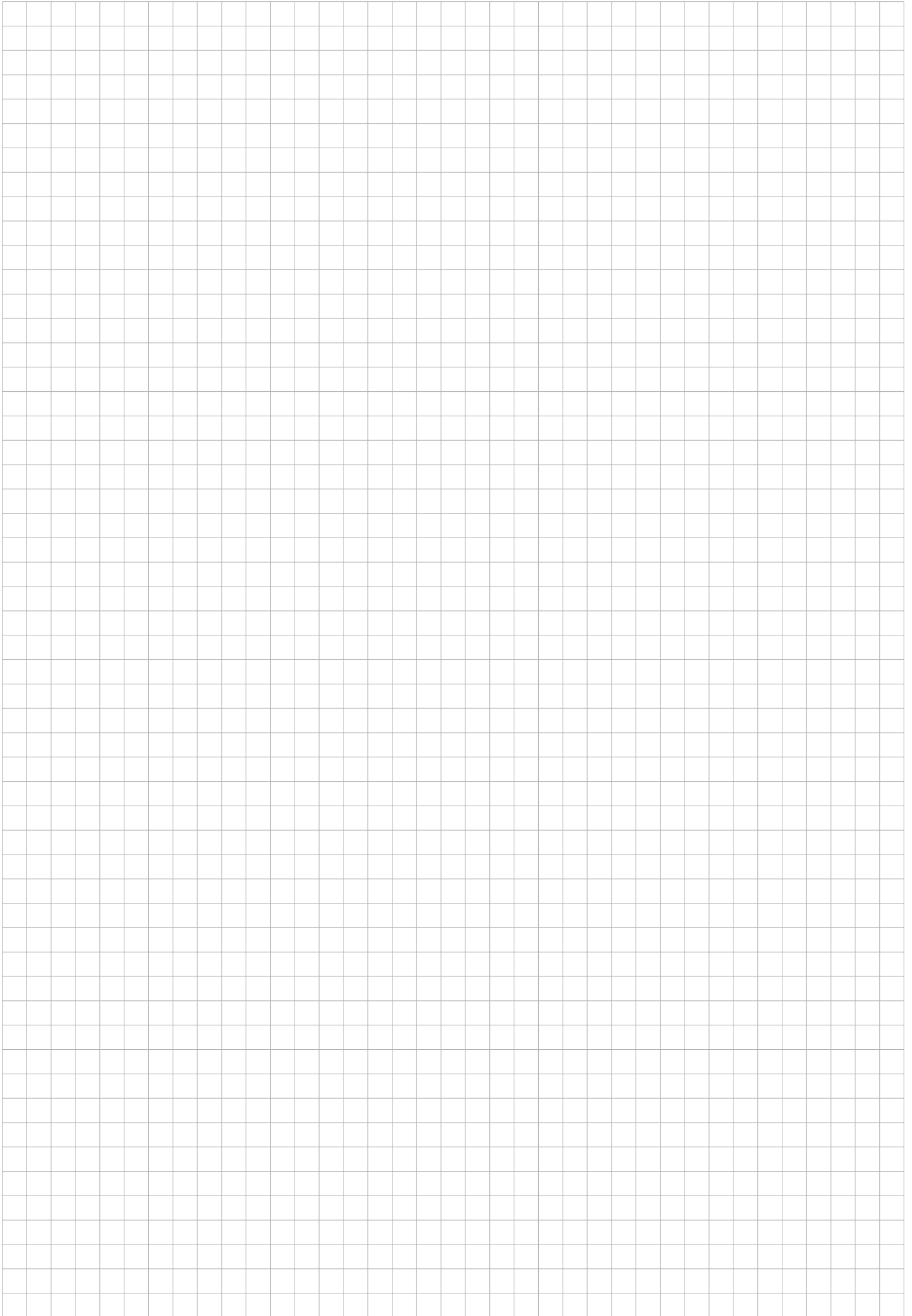

Operation · Einsatz · Utilisation  
 Uso · Эксплуатация

Working range · Arbeitsbereich · Rayon de travail  
 Zona de trabajo · Area di lavoro · Рабочая зона

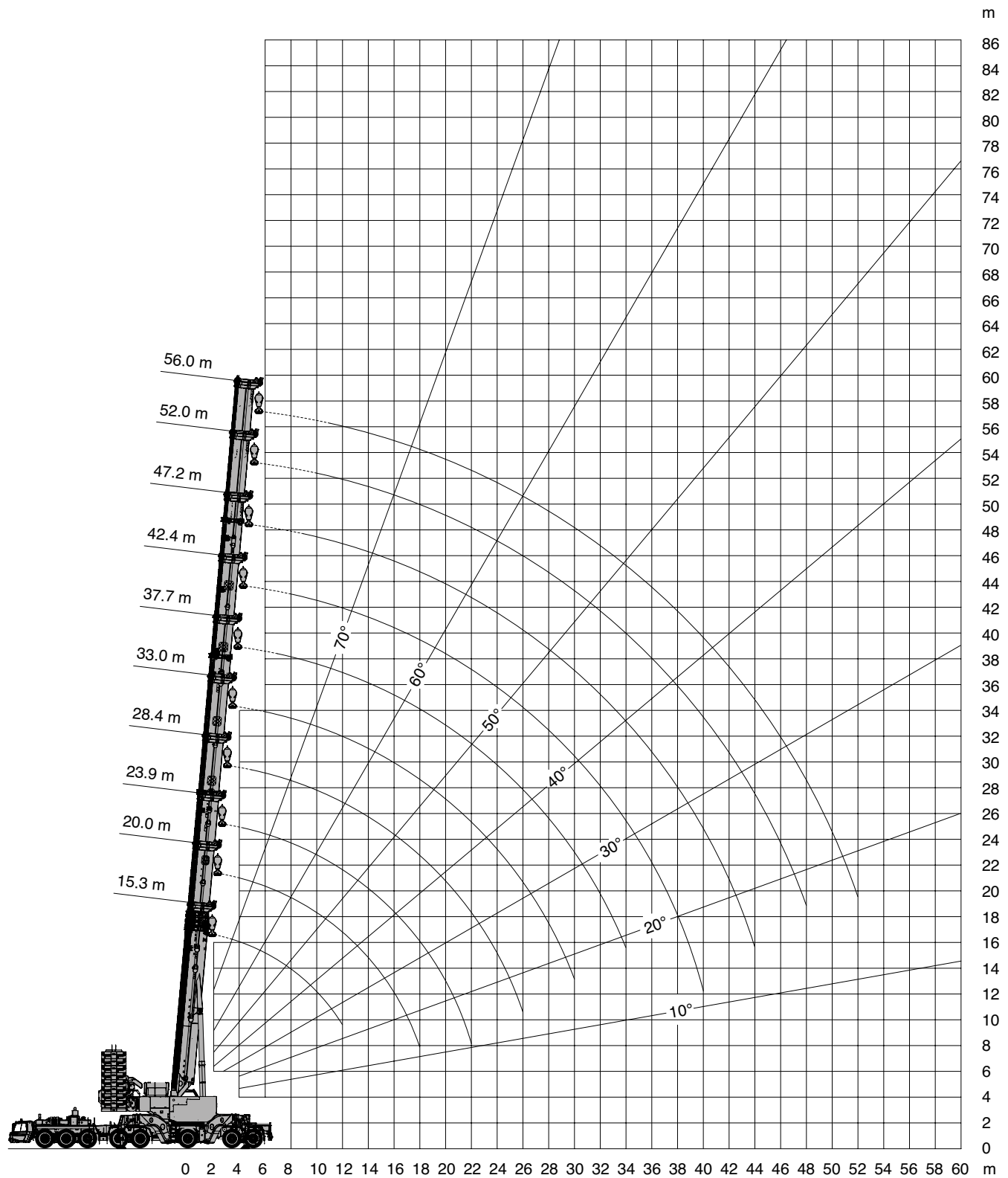

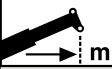

 m	15.3 m*	15.3 m	20.0 m	23.9 m	28.4 m	33.0 m	37.7 m	42.4 m	47.2 m	52.0 m	56.0 m
3.5	600.0**	293.6									
4.0	482.0**	293.6	293.6								
4.5	466.0**	293.6	293.6	293.6							
5.0	432.0**	293.6	291.5	280.0	274.2						
6.0	357.0**	262.0	254.3	243.1	237.5	238.2					
7.0	299.0**	233.3	226.1	215.1	209.7	209.9	202.0				
8.0	256.0	210.2	203.7	193.1	187.9	187.8	180.6	177.9			
9.0	223.0	190.9	185.5	175.2	170.4	170.0	163.4	163.0	145.0		
10.0	198.0	174.1	170.3	160.5	155.8	155.3	149.2	150.9	138.5	122.5	
11.0	177.0	158.8	157.2	147.9	143.6	142.9	137.4	139.7	128.0	116.6	104.8
12.0	160.0	143.8	145.7	137.1	133.1	132.4	127.3	129.3	120.0	111.1	99.5
14.0			125.8	119.2	116.1	115.3	110.9	112.5	106.0	99.0	89.8
16.0			107.7	104.5	102.5	101.9	98.3	99.5	94.4	88.5	81.6
18.0			85.9	91.5	91.3	91.1	88.1	89.0	84.9	79.6	74.6
20.0				78.6	81.6	81.9	79.7	80.5	77.2	72.4	68.7
22.0				61.6	72.6	73.9	72.5	73.2	70.5	65.9	62.8
24.0					63.5	66.7	66.2	67.0	64.7	60.8	57.7
26.0					52.3	59.8	60.6	61.5	59.6	56.1	53.2
28.0						52.8	55.5	56.6	55.3	51.9	49.0
30.0						45.0	50.5	52.1	51.5	48.4	45.8
32.0							45.4	47.8	48.0	45.1	42.8
34.0							39.6	43.6	45.0	42.3	40.0
36.0								39.7	41.9	39.7	37.6
38.0								35.4	38.8	37.4	35.3
40.0								29.7	35.6	35.3	33.2
42.0									32.2	33.2	31.3
44.0									28.1	31.4	29.7
46.0										29.5	28.1
48.0										26.3	26.6
50.0											25.2
52.0											23.2



 m	15.3 m	20.0 m	23.9 m	28.4 m	33.0 m	37.7 m	42.4 m	47.2 m	52.0 m	56.0 m
3.5	293.6									
4.0	293.6	293.6								
4.5	293.6	293.6	293.6							
5.0	293.6	291.5	280.0	274.2						
6.0	262.0	254.3	243.1	237.5	238.2					
7.0	233.3	226.1	215.1	209.7	209.9	202.0				
8.0	210.2	203.7	193.1	187.9	187.8	180.6	177.9			
9.0	190.9	185.5	175.2	170.4	170.0	163.4	163.0	145.0		
10.0	174.1	170.3	160.5	155.8	155.3	149.2	150.9	138.5	122.5	
11.0	158.8	157.2	147.9	143.6	142.9	137.4	139.7	128.0	116.6	104.8
12.0	143.8	145.7	137.1	133.1	132.4	127.3	129.3	120.0	111.1	99.5
14.0		125.8	119.2	116.1	115.3	110.9	112.5	106.0	99.0	89.8
16.0		107.7	104.5	102.5	101.9	98.3	99.5	94.4	88.5	81.6
18.0		85.9	91.5	91.3	91.1	88.1	89.0	84.9	79.6	74.6
20.0			78.6	81.6	81.9	79.7	80.5	77.2	72.4	68.7
22.0			61.6	72.6	73.9	72.5	73.2	70.5	65.9	62.8
24.0				63.5	66.7	66.2	67.0	64.7	60.8	57.7
26.0				52.3	59.8	60.6	61.5	59.6	56.1	53.2
28.0					52.8	55.5	56.6	55.3	51.9	49.0
30.0					45.0	49.8	51.2	51.5	48.4	45.8
32.0						44.9	46.3	47.1	45.1	42.8
34.0							39.6	42.1	42.9	42.3
36.0								38.5	39.2	39.7
38.0								34.8	36.0	36.9
40.0								29.7	33.1	34.0
42.0									30.7	31.5
44.0									28.1	29.3
46.0										27.3
48.0										25.5
50.0										23.6
52.0										22.1

\* Over rear · Nach hinten · A l'arrière · Hacia atrás · Indietro · Назад

\*\* With additional lifting equipment · Mit Zusatzhubausrüstung · Avec équipement de levage supplémentaire

Con equipamiento de elevación adicional · Con attrezzaggio di sollevamento supplementare · С дополнительным подъемным оборудованием

Operation · Einsatz · Utilisation  
 Uso · Эксплуатация



 m	15.3 m	20.0 m	23.9 m	28.4 m	33.0 m	37.7 m	42.4 m	47.2 m	52.0 m	56.0 m
3.5	293.6	293.6								
4.0	293.6	293.6								
4.5	293.6	293.6	293.6							
5.0	291.5	291.5	285.8	281.0						
6.0	256.1	254.3	248.6	243.8	240.1					
7.0	227.5	226.1	220.5	215.7	211.9	203.1				
8.0	204.0	203.7	198.4	193.6	189.8	186.4	177.9			
9.0	184.4	185.5	180.5	175.8	172.1	168.6	163.0	145.0		
10.0	167.8	169.6	165.6	161.1	157.4	154.0	150.9	138.5	122.5	
11.0	153.7	155.5	153.0	148.7	145.1	142.1	139.7	128.0	116.6	104.8
12.0	141.6	143.4	142.2	138.1	134.6	131.6	129.3	120.0	111.1	99.5
14.0		122.6	123.2	120.9	117.6	114.8	112.5	106.0	99.0	89.8
16.0		105.0	105.5	105.0	105.0	101.7	99.5	94.4	88.5	81.6
18.0		85.9	92.0	91.5	92.3	90.4	89.0	84.9	79.6	74.6
20.0			81.4	80.8	81.5	79.6	78.9	77.2	72.4	68.7
22.0			70.8	72.1	72.8	70.9	71.5	70.5	65.9	62.8
24.0				65.0	65.6	63.8	65.4	63.7	60.8	57.7
26.0				59.3	59.1	58.2	58.8	56.8	56.1	53.2
28.0					52.9	52.0	52.6	52.3	51.4	49.0
30.0					47.8	48.7	47.8	47.0	46.1	45.8
32.0					41.5	44.4	43.5	42.6	41.7	41.7
34.0						40.6	39.7	38.8	37.8	37.8
36.0						37.4	36.4	35.5	34.5	34.5
38.0							33.6	32.6	31.6	31.6
40.0							31.1	30.0	29.1	29.0
42.0							24.3	27.8	26.8	26.7
44.0								25.9	24.8	24.6
46.0								23.2	23.0	22.8
48.0									21.4	21.2
50.0										19.7
52.0										18.4



 m	15.3 m	20.0 m	23.9 m	28.4 m	33.0 m	37.7 m	42.4 m	47.2 m	52.0 m	56.0 m
3.5	293.6									
4.0	293.6	293.6								
4.5	293.6	293.6	293.6							
5.0	293.6	291.5	280.0	274.2						
6.0	260.9	254.3	243.1	237.5	238.2					
7.0	231.6	226.1	215.1	209.7	209.9	202.0				
8.0	207.5	203.7	193.1	187.9	187.8	180.6	177.9			
9.0	187.4	185.5	175.2	170.4	170.0	163.4	163.0	145.0		
10.0	170.5	170.3	160.5	155.8	155.3	149.2	150.9	138.5	122.5	
11.0	156.1	157.2	147.9	143.6	142.9	137.4	139.7	128.0	116.6	104.8
12.0	142.9	144.7	137.1	133.1	132.4	127.3	129.3	120.0	111.1	99.5
14.0		121.1	116.4	116.1	115.3	110.9	112.5	106.0	99.0	89.8
16.0		103.7	98.9	99.3	100.4	98.3	98.4	94.4	88.5	81.6
18.0		85.9	82.1	82.6	84.2	84.7	84.2	83.0	79.6	74.6
20.0			68.6	69.0	70.5	70.9	72.7	72.4	72.0	68.7
22.0			58.5	58.8	60.2	60.5	62.2	63.2	63.7	62.5
24.0				50.7	52.0	52.3	53.9	54.9	56.1	55.8
26.0				44.4	45.5	45.7	47.3	48.2	49.3	49.4
28.0					40.2	40.3	41.8	42.7	43.8	43.8
30.0					35.8	35.8	37.2	38.1	39.1	39.2
32.0						32.0	33.4	34.2	35.2	35.2
34.0						28.8	30.1	30.8	31.8	31.8
36.0							27.3	27.9	28.9	28.9
38.0							24.8	25.4	26.3	26.3
40.0							22.8	23.2	24.1	24.0
42.0								21.3	22.1	22.0
44.0								19.6	20.3	20.2
46.0									18.8	18.6
48.0									17.4	17.1
50.0										15.8
52.0										14.7



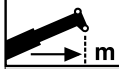

 m	15.3 m	20.0 m	23.9 m	28.4 m	33.0 m	37.7 m	42.4 m	47.2 m	52.0 m	56.0 m
3.5	293.6	293.6								
4.0	293.6	293.6								
4.5	293.6	293.6	293.6							
5.0	289.5	290.7	285.8	281.0						
6.0	253.5	254.3	248.6	243.8	240.1					
7.0	224.6	226.0	220.5	215.7	211.9	203.1				
8.0	200.9	202.4	198.4	193.6	189.8	186.4	177.9			
9.0	181.1	182.8	180.5	175.8	172.1	168.6	163.0	145.0		
10.0	164.5	166.3	165.6	161.1	157.4	154.0	150.9	138.5	122.5	
11.0	148.3	150.1	150.7	148.7	145.1	142.1	137.8	128.0	116.6	104.8
12.0	133.9	135.7	136.3	135.8	134.3	128.8	123.2	119.2	111.1	99.5
14.0		113.4	114.0	113.5	110.5	105.8	103.0	99.5	95.9	89.8
16.0		91.8	92.6	94.2	92.3	88.8	87.5	83.9	81.0	79.0
18.0		75.6	76.2	78.3	77.2	78.1	75.1	72.2	69.6	68.0
20.0			65.0	66.2	66.1	66.0	65.2	63.0	60.7	59.4
22.0			56.0	57.0	56.9	56.8	56.0	55.0	53.5	52.4
24.0				49.8	49.7	49.5	48.7	47.7	46.8	46.6
26.0				44.1	43.8	43.6	42.8	41.9	41.0	41.0
28.0					39.1	38.8	38.0	37.1	36.2	36.2
30.0					35.2	34.8	34.0	33.1	32.2	32.2
32.0					31.9	31.5	30.6	29.7	28.7	28.7
34.0						28.6	27.7	26.7	25.8	25.8
36.0						26.2	25.2	24.2	23.3	23.2
38.0							23.0	22.0	21.1	21.0
40.0							21.2	20.1	19.1	19.0
42.0							19.1	18.4	17.4	17.3
44.0								16.9	15.9	15.7
46.0								15.7	14.5	14.3
48.0									13.3	13.1
50.0										12.0
52.0										11.0



 m	15.3 m	20.0 m	23.9 m	28.4 m	33.0 m	37.7 m	42.4 m	47.2 m	52.0 m	56.0 m
3.5	293.6	293.6								
4.0	293.6	293.6								
4.5	293.6	293.6	293.6							
5.0	281.4	282.5	282.9	281.0						
6.0	245.8	247.1	247.6	243.8	240.1					
7.0	217.2	218.7	219.2	215.7	211.9	203.1				
8.0	193.8	195.4	196.0	193.6	189.8	186.4	177.8			
9.0	174.2	176.0	176.7	175.8	170.1	159.7	152.5	145.0		
10.0	154.9	156.7	157.3	154.3	145.4	139.6	132.0	127.7	122.0	
11.0	138.4	140.2	140.8	133.7	128.8	122.2	118.8	112.8	108.0	104.5
12.0	124.9	126.7	123.9	118.7	113.9	111.0	105.9	100.8	96.7	93.7
14.0		96.0	97.0	97.1	93.5	90.3	86.4	82.5	79.3	77.1
16.0		75.8	77.4	78.9	78.0	75.5	72.4	69.3	66.6	64.9
18.0		62.1	63.4	64.8	64.7	64.6	61.9	59.3	56.9	55.6
20.0			53.3	54.5	54.4	54.3	53.5	51.4	49.4	48.2
22.0			45.7	46.7	46.6	46.5	45.7	44.7	43.2	42.3
24.0				40.6	40.5	40.3	39.5	38.5	37.7	37.4
26.0				35.8	35.5	35.3	34.5	33.6	32.7	32.7
28.0					31.5	31.2	30.4	29.5	28.6	28.6
30.0					28.2	27.9	27.0	26.1	25.2	25.2
32.0					25.5	25.0	24.1	23.2	22.3	22.3
34.0						22.6	21.7	20.7	19.8	19.8
36.0						20.6	19.6	18.6	17.7	17.6
38.0							17.7	16.7	15.8	15.7
40.0							16.2	15.1	14.1	14.0
42.0							14.4	13.7	12.7	12.6
44.0								12.5	11.4	11.2
46.0								11.5	10.3	10.1
48.0									9.3	9.0
50.0										8.1
52.0										7.3

Operation · Einsatz · Utilisation  
 Uso · Эксплуатация

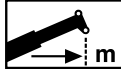

 m	15.3 m	20.0 m	23.9 m	28.4 m	33.0 m	37.7 m	42.4 m	47.2 m	52.0 m	56.0 m
3.5	293.6	293.6								
4.0	293.6	293.6								
4.5	293.6	293.6	293.6							
5.0	272.7	273.9	274.3	273.8						
6.0	237.5	238.9	239.3	238.9	238.4					
7.0	209.3	210.8	211.3	210.9	204.6	188.6				
8.0	185.7	187.4	188.0	177.9	164.9	155.8	147.2			
9.0	163.0	164.9	157.3	147.9	139.7	133.9	125.9	118.2		
10.0	143.9	139.3	132.9	127.7	121.0	115.2	108.9	102.7	97.8	
11.0	119.4	119.0	114.4	110.7	105.4	100.8	95.6	90.5	86.3	83.4
12.0	99.6	102.8	100.0	97.3	93.1	89.4	84.9	80.6	77.0	74.5
14.0		76.4	78.1	77.9	74.9	72.2	68.9	65.5	62.6	60.8
16.0		59.8	61.4	62.9	62.1	60.1	57.3	54.6	52.2	50.8
18.0		48.6	49.9	51.3	51.3	51.0	48.7	46.3	44.2	43.1
20.0			41.6	42.8	42.8	42.6	41.8	39.9	38.0	37.1
22.0			35.4	36.4	36.3	36.2	35.4	34.4	33.0	32.1
24.0				31.4	31.3	31.1	30.3	29.4	28.5	28.1
26.0				27.5	27.2	27.0	26.2	25.3	24.4	24.4
28.0					23.9	23.7	22.9	21.9	21.0	21.0
30.0					21.2	20.9	20.1	19.1	18.2	18.2
32.0					19.0	18.5	17.7	16.7	15.8	15.8
34.0						16.6	15.7	14.7	13.8	13.8
36.0						14.9	13.9	13.0	12.0	12.0
38.0							12.5	11.4	10.5	10.4
40.0							11.2	10.1	9.2	9.1
42.0							9.7	9.0	8.0	7.9
44.0								8.0	6.9	6.8
46.0								7.2	6.0	5.8
48.0									5.2	5.0
50.0										4.2
52.0										3.6



 m	15.3 m	20.0 m	23.9 m	28.4 m	33.0 m	37.7 m	42.4 m	47.2 m	52.0 m	56.0 m
3.5	293.6	293.6								
4.0	293.6	293.6								
4.5	284.3	285.4	285.8							
5.0	263.5	264.7	265.1	264.6						
6.0	228.6	230.1	230.6	230.1	206.8					
7.0	199.8	201.5	190.3	174.0	160.3	150.3				
8.0	171.2	159.3	148.6	140.3	130.5	122.4	113.9			
9.0	134.9	127.7	121.0	115.6	108.6	102.7	96.1	89.9		
10.0	110.4	105.9	101.4	97.8	92.5	88.0	82.8	77.7	73.6	
11.0	89.8	89.9	86.8	84.4	80.2	76.7	72.3	68.1	64.6	62.3
12.0	74.3	77.5	75.6	73.9	70.5	67.6	63.9	60.3	57.2	55.3
14.0		56.8	58.6	58.5	56.2	54.1	51.3	48.4	45.9	44.5
16.0		43.8	45.4	47.0	46.1	44.6	42.2	39.9	37.7	36.6
18.0		35.1	36.4	37.8	37.8	37.4	35.4	33.4	31.5	30.6
20.0			29.9	31.2	31.1	31.0	30.1	28.3	26.6	25.8
22.0			25.1	26.1	26.0	25.9	25.1	24.1	22.6	22.0
24.0				22.2	22.1	21.9	21.1	20.2	19.3	18.8
26.0				19.2	18.9	18.7	17.9	17.0	16.1	16.1
28.0					16.3	16.1	15.3	14.3	13.4	13.5
30.0					14.2	13.9	13.1	12.1	11.2	11.3
32.0					12.5	12.1	11.2	10.3	9.4	9.4
34.0						10.6	9.7	8.7	7.8	7.8
36.0						9.3	8.3	7.3	6.4	6.4
38.0							7.2	6.2	5.2	5.2
40.0							6.2	5.2	4.2	4.1
42.0							5.0	4.3	3.3	3.2
44.0								3.5	2.5	2.3
46.0								3.0		

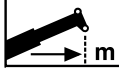

 m	15.3 m	20.0 m	23.9 m	28.4 m	33.0 m	37.7 m	42.4 m	47.2 m	52.0 m	56.0 m
3.5	293.6	293.6								
4.0	293.6	293.6								
4.5	274.2	275.4	275.8							
5.0	253.6	254.9	255.3	254.9						
6.0	217.9	212.3	187.2	169.2	151.2					
7.0	161.4	147.2	134.9	125.6	114.9	106.2				
8.0	118.3	111.2	104.3	98.9	91.8	85.9	79.3			
9.0	92.1	88.3	84.1	80.9	75.8	71.5	66.4	61.5		
10.0	74.4	72.4	69.9	67.9	64.1	60.7	56.7	52.6	49.4	
11.0	60.2	60.8	59.3	58.1	55.1	52.5	49.0	45.6	42.8	41.1
12.0	49.0	52.0	51.1	50.4	48.0	45.9	42.9	40.0	37.4	36.0
14.0		37.3	39.1	39.2	37.5	36.0	33.7	31.3	29.2	28.2
16.0		27.9	29.5	31.0	30.2	29.0	27.1	25.1	23.3	22.5
18.0		21.7	23.0	24.4	24.3	23.8	22.1	20.4	18.7	18.1
20.0			18.3	19.5	19.5	19.3	18.3	16.7	15.2	14.6
22.0			14.9	15.9	15.8	15.6	14.9	13.7	12.3	11.8
24.0				13.0	12.9	12.7	12.0	11.0	9.9	9.5
26.0				10.9	10.6	10.4	9.6	8.7	7.8	7.5
28.0					8.7	8.5	7.7	6.8	5.9	5.9
30.0					7.3	6.9	6.1	5.2	4.3	4.3
32.0					6.1	5.6	4.8	3.8	2.9	2.9
34.0						4.6	3.7	2.7		
36.0						3.7	2.7			

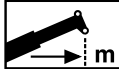

 m	15.3 m	20.0 m	23.9 m	28.4 m	33.0 m	37.7 m	42.4 m	47.2 m	52.0 m	56.0 m
3.5	293.6									
4.0	286.7	287.9								
4.5	263.4	264.7	261.3							
5.0	241.7	234.0	191.7	168.0						
6.0	142.8	125.9	97.0	85.8	78.8					
7.0	91.6	85.4	65.7	59.9	56.7	52.4				
8.0	65.2	63.0	47.6	44.2	42.8	40.1	39.4			
9.0	49.1	48.7	35.7	33.7	33.3	31.4	31.5	30.7		
10.0	38.2	38.9	27.4	26.1	26.3	25.0	25.5	25.2	25.2	
11.0	30.5	31.7	21.2	20.4	20.9	20.0	20.8	20.8	21.1	20.0
12.0	23.6	26.2	16.4	15.9	16.7	16.1	17.1	17.3	17.7	16.8
14.0		17.7	9.5	9.5	10.6	10.3	11.5	11.9	12.6	11.9
16.0		11.9	4.8	5.0	6.2	6.1	7.5	8.0	8.9	8.3
18.0		8.1			3.0	3.0	4.5	5.1	6.0	5.6
20.0							2.2		3.8	

Operation · Einsatz · Utilisation  
 Uso · Эксплуатация

Working range · Arbeitsbereich · Rayon de travail  
 Zona de trabajo · Area di lavoro · Рабочая зона

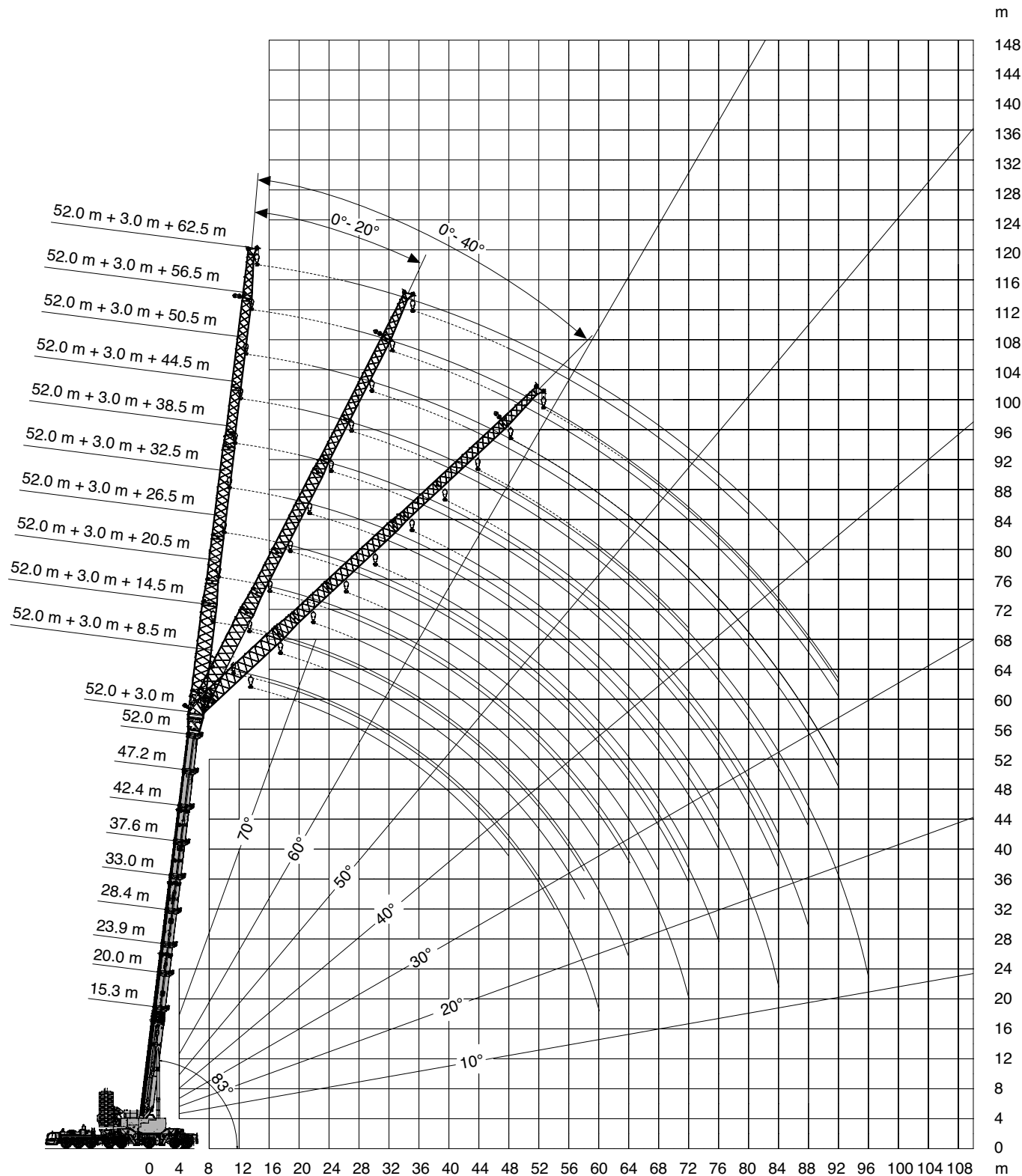
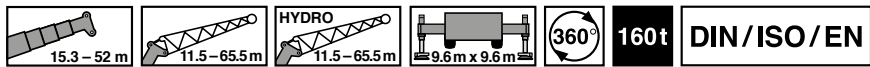

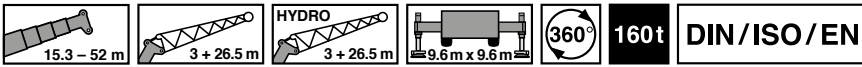

Lifting capacities · Traglasten · Charges de levage  
 Cargas · Portate · Грузоподъемность



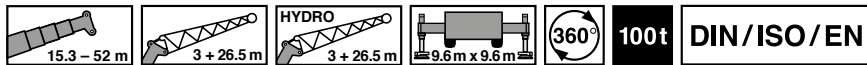

 m	15.3 m + 3.0 m + 26.5 m			42.4 m + 3.0 m + 26.5 m			47.2 m + 3.0 m + 26.5 m			52.0 m + 3.0 m + 26.5 m		
	0°	20°	40°	0°	20°	40°	0°	20°	40°	0°	20°	40°
7.0	85.8											
8.0	79.4											
9.0	69.9											
10.0	62.2											
12.0	50.6											
14.0	42.6			59.8			53.9					
16.0	36.3	27.3		54.3			52.3					
18.0	31.9	24.4		48.7			48.4			42.9		
20.0	28.2	22.3		43.8			44.0			39.5		
22.0	25.2	20.4		39.7	25.0		40.3	24.6		36.0		
24.0	22.7	18.7	16.1	36.3	23.4		37.1	23.4		33.6		
26.0	20.6	17.2	14.8	33.2	22.1		34.2	22.2		31.2	22.2	
28.0	18.7	16.2	14.1	30.7	20.9		31.9	21.1		28.9	21.0	
30.0	17.2	15.2	13.3	28.5	19.8	15.3	29.6	20.1	15.3	26.9	20.0	
32.0	15.9	13.9	12.5	26.6	18.9	14.7	27.7	19.2	14.8	25.1	19.2	14.6
34.0	14.6	13.1	12.1	24.9	18.0	14.2	25.8	18.4	14.3	23.5	18.4	14.2
36.0	13.6	12.4	11.5	23.3	17.2	13.7	24.2	17.6	13.9	22.0	17.6	13.7
38.0	12.6	11.7	10.9	21.9	16.6	13.3	22.6	16.8	13.5	20.6	17.0	13.3
40.0	11.8	11.1		20.6	16.0	12.9	21.3	16.1	13.1	19.4	16.3	13.0
42.0	11.1			19.5	15.2	12.6	20.1	15.5	12.8	18.3	15.8	12.7
44.0				18.6	14.4	12.2	19.0	15.0	12.5	17.2	15.3	12.7
46.0				17.7	14.0	11.8	18.0	14.6	12.1	16.2	14.9	12.4
48.0				16.8	13.5	11.5	17.0	14.0	11.8	15.3	14.1	12.0
50.0				16.0	13.1	11.3	16.1	13.4	11.5	14.4	13.5	11.7
52.0				15.2	12.7	11.1	15.3	13.0	11.2	13.6	12.9	11.5
54.0				14.4	12.3	11.0	14.6	12.6	11.0	12.9	12.3	11.3
56.0				13.8	11.9	10.8	13.9	12.3	10.9	12.3	11.7	11.1
58.0				13.2	11.5	10.6	13.2	12.0	10.8	11.7	11.1	10.9
60.0				12.8	11.1	10.5	12.6	11.6	10.7	11.1	10.6	10.4
64.0				11.8			11.4	10.7	10.6	9.9	9.7	9.6
68.0				10.8			10.2			9.0	8.8	8.7
72.0							9.2			8.2	7.9	
76.0										7.3		

Operation · Einsatz · Utilisation  
 Uso · Эксплуатация

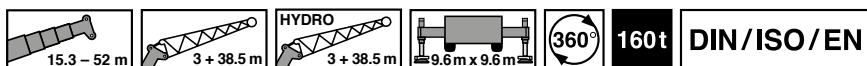

 m	15.3 m + 3.0 m + 26.5 m			42.4 m + 3.0 m + 26.5 m			47.2 m + 3.0 m + 26.5 m			52.0 m + 3.0 m + 26.5 m		
	0°	20°	40°	0°	20°	40°	0°	20°	40°	0°	20°	40°
7.0	85.8											
8.0	79.4											
9.0	69.9											
10.0	62.2											
12.0	50.6											
14.0	42.6			59.8			53.9					
16.0	36.3	27.3		54.3			52.3					
18.0	31.9	24.4		48.7			48.4			42.9		
20.0	28.2	22.3		43.8			44.0			39.5		
22.0	25.2	20.4		39.7	25.0		40.3	24.6		36.0		
24.0	22.7	18.7	16.1	36.3	23.4		37.1	23.4		33.6		
26.0	20.6	17.2	14.8	33.2	22.1		34.2	22.2		31.2	22.2	
28.0	18.7	16.2	14.1	30.7	20.9		31.9	21.1		28.9	21.0	
30.0	17.2	15.2	13.3	28.5	19.8	15.3	29.6	20.1	15.3	26.9	20.0	
32.0	15.9	13.9	12.5	26.6	18.9	14.7	27.7	19.2	14.8	25.1	19.2	14.6
34.0	14.6	13.1	12.1	24.9	18.0	14.2	25.4	18.4	14.3	23.5	18.4	14.2
36.0	13.6	12.4	11.5	22.6	17.2	13.7	22.8	17.6	13.9	22.0	17.6	13.7
38.0	12.6	11.7	10.9	20.3	16.6	13.3	20.4	16.8	13.5	20.5	17.0	13.3
40.0	11.8	11.1		18.2	16.0	12.9	18.3	16.1	13.1	18.4	16.3	13.0
42.0	11.1			16.3	15.2	12.6	16.5	15.5	12.8	16.6	15.8	12.7
44.0				14.7	14.4	12.2	14.8	15.0	12.5	14.9	15.3	12.7
46.0				13.2	14.0	11.8	13.3	14.6	12.1	13.4	14.9	12.4
48.0				11.8	13.5	11.5	12.0	14.0	11.8	12.1	14.1	12.0
50.0				10.6	12.6	11.3	10.7	12.9	11.5	10.8	13.1	11.7
52.0				9.5	11.4	11.1	9.6	11.6	11.2	9.7	11.8	11.5
54.0				8.5	10.2	11.0	8.6	10.4	11.0	8.7	10.6	11.3
56.0				7.6	9.1	9.9	7.7	9.3	10.1	7.8	9.6	10.5
58.0				6.7	8.1	8.8	6.8	8.3	9.3	6.9	8.6	9.7
60.0				5.9	7.1	7.7	6.0	7.4	8.2	6.1	7.6	8.6
64.0				4.5			4.6	5.7	6.3	4.7	6.0	6.7
68.0				3.4			3.4			3.5	4.5	5.0
72.0							2.4			2.4	3.2	



 m	15.3 m + 3.0 m + 38.5 m			42.4 m + 3.0 m + 38.5 m			47.2 m + 3.0 m + 38.5 m			52.0 m + 3.0 m + 38.5 m		
	0°	20°	40°	0°	20°	40°	0°	20°	40°	0°	20°	40°
9.0	60.5											
10.0	54.0											
12.0	44.0											
14.0	36.8											
16.0	31.5											
18.0	27.4			38.0			35.0					
20.0	24.2			35.2			33.4			31.7		
22.0	21.6	17.0		31.8			31.7			30.3		
24.0	19.4	15.5		28.9			29.1			27.9		
26.0	17.6	14.4		26.3			27.0			26.0		
28.0	16.1	13.4		24.3			24.8			23.9		
30.0	14.7	12.2		22.3	14.5		23.0	14.8		22.5		
32.0	13.4	11.5		20.8	13.7		21.3	13.8		20.9		
34.0	12.4	10.6	9.2	19.4	13.2		20.0	13.1		19.6	13.1	
36.0	11.5	9.9	8.6	18.1	12.5		18.8	12.5		18.5	12.5	
38.0	10.6	9.3	8.1	16.8	11.8		17.6	11.8		17.3	11.8	
40.0	9.7	8.6	7.7	15.8	11.2	8.6	16.3	11.4	8.7	16.3	11.3	
42.0	9.1	8.2	7.5	14.9	10.7	8.3	15.4	11.1	8.4	15.5	10.9	8.3
44.0	8.5	7.6	7.0	14.0	10.3	8.0	14.4	10.6	8.1	14.6	10.6	7.9
46.0	7.9	7.3	6.7	13.2	9.9	7.7	13.7	10.2	7.9	13.7	10.2	7.8
48.0	7.6	7.1	6.2	12.4	9.5	7.5	13.1	9.7	7.7	13.1	9.8	7.6
50.0	7.1	6.6	6.0	11.8	9.1	7.3	12.5	9.3	7.6	12.4	9.4	7.2
52.0	6.6			11.3	8.8	7.1	11.8	9.0	7.3	11.7	9.0	7.1
54.0	6.2			10.8	8.5	7.0	11.2	8.7	7.1	11.0	8.7	7.1
56.0				10.3	8.1	6.7	10.7	8.4	7.0	10.4	8.4	6.8
58.0				9.9	7.8	6.5	10.2	8.1	6.9	9.8	8.1	6.5
60.0				9.4	7.5	6.4	9.8	7.8	6.6	9.3	7.9	6.4
64.0				8.3	7.0	6.2	9.0	7.3	6.3	8.3	7.4	6.0
68.0				7.7	6.5	6.1	8.0	6.8	6.1	7.3	6.9	6.0
72.0				7.2	6.1	5.9	7.2	6.4	6.0	6.7	6.4	5.7
76.0				6.7			6.5	6.0	5.8	6.0	5.8	5.7
80.0							6.0			5.2	5.2	
84.0							5.2			4.7	4.7	
88.0										4.1		

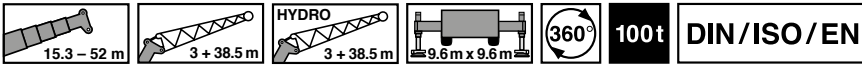

m	15.3 m + 3.0 m + 38.5 m			42.4 m + 3.0 m + 38.5 m			47.2 m + 3.0 m + 38.5 m			52.0 m + 3.0 m + 38.5 m		
	0°	20°	40°	0°	20°	40°	0°	20°	40°	0°	20°	40°
9.0	60.5											
10.0	54.0											
12.0	44.0											
14.0	36.8											
16.0	31.5											
18.0	27.4			38.0			35.0					
20.0	24.2			35.2			33.4			31.7		
22.0	21.6	17.0		31.8			31.7			30.3		
24.0	19.4	15.5		28.9			29.1			27.9		
26.0	17.6	14.4		26.3			27.0			26.0		
28.0	16.1	13.4		24.3			24.8			23.9		
30.0	14.7	12.2		22.3	14.5		23.0	14.8		22.5		
32.0	13.4	11.5		20.8	13.7		21.3	13.8		20.9		
34.0	12.4	10.6	9.2	19.4	13.2		20.0	13.1		19.6	13.1	
36.0	11.5	9.9	8.6	18.1	12.5		18.8	12.5		18.5	12.5	
38.0	10.6	9.3	8.1	16.8	11.8		17.6	11.8		17.3	11.8	
40.0	9.7	8.6	7.7	15.8	11.2	8.6	16.3	11.4	8.7	16.3	11.3	
42.0	9.1	8.2	7.5	14.9	10.7	8.3	15.4	11.1	8.4	15.5	10.9	8.3
44.0	8.5	7.6	7.0	14.0	10.3	8.0	14.4	10.6	8.1	14.6	10.6	7.9
46.0	7.9	7.3	6.7	13.2	9.9	7.7	13.7	10.2	7.9	13.7	10.2	7.8
48.0	7.6	7.1	6.2	12.4	9.5	7.5	12.8	9.7	7.7	12.8	9.8	7.6
50.0	7.1	6.6	6.0	11.3	9.1	7.3	11.5	9.3	7.6	11.5	9.4	7.2
52.0	6.6			10.2	8.8	7.1	10.4	9.0	7.3	10.4	9.0	7.1
54.0	6.2			9.2	8.5	7.0	9.3	8.7	7.1	9.3	8.7	7.1
56.0				8.2	8.1	6.7	8.4	8.4	7.0	8.4	8.4	6.8
58.0				7.3	7.8	6.5	7.5	8.1	6.9	7.5	8.1	6.5
60.0				6.5	7.5	6.4	6.7	7.8	6.6	6.7	7.9	6.4
64.0				5.1	6.9	6.2	5.2	7.0	6.3	5.2	7.1	6.0
68.0				3.8	5.4	6.1	3.9	5.5	6.1	3.9	5.6	6.0
72.0				2.7	4.0	4.8	2.8	4.2	5.2	2.8	4.3	5.4
76.0								2.9	3.6		3.1	4.0
80.0											2.0	

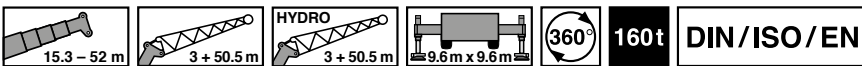

m	15.3 m + 3.0 m + 50.5 m			42.4 m + 3.0 m + 50.5 m			47.2 m + 3.0 m + 50.5 m			52.0 m + 3.0 m + 50.5 m		
	0°	20°	40°	0°	20°	40°	0°	20°	40°	0°	20°	40°
12.0	39.9											
14.0	33.4											
16.0	28.5											
18.0	24.7											
20.0	21.8											
22.0	19.4			25.7			24.1			22.4		
24.0	17.3			23.6			23.5			22.0		
26.0	15.5			21.6			21.8			20.7		
28.0	14.1	11.3		19.8			20.1			19.4		
30.0	12.8	10.4		18.3			18.7			18.0		
32.0	11.7	9.5		16.9			17.3			17.0		
34.0	10.7	8.7		15.6			16.1			16.3		
36.0	9.7	8.2		14.5	9.5		15.0	9.7		15.2		
38.0	9.0	7.5		13.6	9.1		14.0	9.1		14.1		
40.0	8.3	7.0		12.7	8.6		13.1	8.7		13.3		
42.0	7.7	6.5		11.9	8.0		12.2	8.2		12.5	8.3	
44.0	7.1	6.1	5.2	11.2	7.7		11.5	7.7		11.7	7.9	
46.0	6.5	5.6	4.8	10.5	7.4		10.9	7.2		11.0	7.6	
48.0	6.0	5.3	4.6	9.8	6.9	5.1	10.2	6.9		10.4	7.3	
50.0	5.6	5.0	4.3	9.2	6.4	4.9	9.7	6.7	4.9	9.8	6.8	
52.0	5.2	4.6	4.0	8.7	6.2	4.8	9.2	6.3	4.8	9.3	6.5	
54.0	4.8	4.3	3.8	8.2	6.0	4.7	8.7	6.0	4.7	8.8	6.2	
56.0	4.5	4.0	3.5	7.8	5.6	4.5	8.2	5.7	4.5	8.3	5.9	
58.0	4.1	3.7	3.2	7.4	5.3	4.3	7.7	5.5	4.4	7.8	5.7	3.4
60.0	3.8	3.4	2.9	7.0	5.0	4.1	7.3	5.3	4.2	7.4	5.4	3.2
64.0	3.2			6.2	4.7	3.6	6.6	4.8	3.9	6.4	4.9	2.8
68.0				5.6	4.1	3.3	5.9	4.4	3.5	5.5	4.6	2.5
72.0				5.0	3.9	3.0	5.4	4.1	3.2	4.8	4.4	2.2
76.0				4.5	3.6	2.8	4.8	3.7	3.0	4.2	3.9	
80.0				4.0	3.3	2.8	4.3	3.4	2.9	3.7	3.6	
84.0				3.6	3.0	2.8	3.9	3.2	2.9	3.2	3.1	
88.0							3.4	3.0	2.6	2.6	2.7	
92.0							2.9			2.1	2.2	
96.0							2.5					

Operation · Einsatz · Utilisation  
 Uso · Эксплуатация

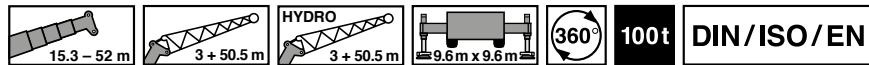

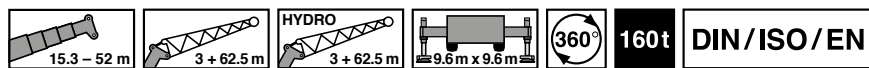

m	15.3 m + 3.0 m + 50.5 m			42.4 m + 3.0 m + 50.5 m			47.2 m + 3.0 m + 50.5 m			52.0 m + 3.0 m + 50.5 m		
	0°	20°	40°	0°	20°	40°	0°	20°	40°	0°	20°	40°
12.0	39.9											
14.0	33.4											
16.0	28.5											
18.0	24.7											
20.0	21.8											
22.0	19.4			25.7			24.1			22.4		
24.0	17.3			23.6			23.5			22.0		
26.0	15.5			21.6			21.8			20.7		
28.0	14.1	11.3		19.8			20.1			19.4		
30.0	12.8	10.4		18.3			18.7			18.0		
32.0	11.7	9.5		16.9			17.3			17.0		
34.0	10.7	8.7		15.6			16.1			16.3		
36.0	9.7	8.2		14.5	9.5		15.0	9.7		15.2		
38.0	9.0	7.5		13.6	9.1		14.0	9.1		14.1		
40.0	8.3	7.0		12.7	8.6		13.1	8.7		13.3		
42.0	7.7	6.5		11.9	8.0		12.2	8.2		12.5	8.3	
44.0	7.1	6.1	5.2	11.2	7.7		11.5	7.7		11.7	7.9	
46.0	6.5	5.6	4.8	10.5	7.4		10.9	7.2		11.0	7.6	
48.0	6.0	5.3	4.6	9.8	6.9	5.1	10.2	6.9		10.4	7.3	
50.0	5.6	5.0	4.3	9.2	6.4	4.9	9.7	6.7	4.9	9.8	6.8	
52.0	5.2	4.6	4.0	8.7	6.2	4.8	9.2	6.3	4.8	9.3	6.5	
54.0	4.8	4.3	3.8	8.2	6.0	4.7	8.7	6.0	4.7	8.8	6.2	
56.0	4.5	4.0	3.5	7.8	5.6	4.5	8.1	5.7	4.5	8.2	5.9	
58.0	4.1	3.7	3.2	7.4	5.3	4.3	7.6	5.5	4.4	7.6	5.7	3.4
60.0	3.8	3.4	2.9	6.9	5.0	4.1	6.8	5.3	4.2	6.7	5.4	3.2
64.0	3.2			5.4	4.7	3.6	5.3	4.8	3.9	5.2	4.9	2.8
68.0				4.1	4.1	3.3	4.0	4.4	3.5	3.9	4.6	2.5
72.0				3.0	3.9	3.0	2.9	4.1	3.2	2.8	4.4	2.2
76.0				2.0	3.6	2.8	1.9	3.7	3.0		3.8	
80.0					2.5	2.8		2.6	2.9		2.6	
84.0						2.1			2.4			



m	15.3 m + 3.0 m + 62.5 m			42.4 m + 3.0 m + 62.5 m			47.2 m + 3.0 m + 62.5 m			52.0 m + 3.0 m + 62.5 m		
	0°	20°	40°	0°	20°	40°	0°	20°	40°	0°	20°	40°
14.0	31.3											
16.0	26.7											
18.0	23.1											
20.0	20.3											
22.0	17.9											
24.0	16.0			19.4			18.6					
26.0	14.3			18.1			18.4			14.9		
28.0	12.9			16.8			17.7			14.8		
30.0	11.7			15.6			16.3			14.4		
32.0	10.6			14.4			15.0			13.6		
34.0	9.6			13.4			14.0			13.0		
36.0	8.8	7.2		12.3			12.9			12.3		
38.0	8.1	6.6		11.5			12.1			11.2		
40.0	7.4	6.1		10.7			11.2			10.2		
42.0	6.8	5.6		10.0			10.4			9.5		
44.0	6.2	5.1		9.3	6.2		9.8	6.1		8.9		
46.0	5.6	4.8		8.7	5.7		9.1	5.8		8.4		
48.0	5.1	4.4		8.1	5.5		8.6	5.5		7.9	5.3	
50.0	4.7	4.0		7.6	5.3		8.0	5.2		7.4	5.0	
52.0	4.3	3.7		7.1	4.9		7.5	4.9		6.9	4.7	
54.0	4.0	3.4	2.7	6.7	4.5		7.1	4.6		6.5	4.5	
56.0	3.6	3.1	2.4	6.3	4.2		6.7	4.3		6.1	4.2	
58.0	3.3	2.8	2.2	5.9	3.9		6.3	4.1		5.8	4.0	
60.0	3.0	2.5	2.0	5.5	3.7	2.6	5.9	3.9	2.6	5.5	3.8	
64.0	2.5	2.1		4.9	3.3	2.3	5.2	3.5	2.3	4.9	3.4	2.3
68.0	2.0			4.1	2.9	2.0	4.6	3.1	2.1	4.4	3.0	2.0
72.0				3.7	2.6		4.1	2.8		3.9	2.7	
76.0				3.3	2.3		3.6	2.5		3.4	2.4	
80.0				2.9	2.0		3.2	2.2		2.9	2.2	
84.0				2.5			2.8	2.0		2.5		
88.0				2.1			2.5			2.0		
92.0							2.1					

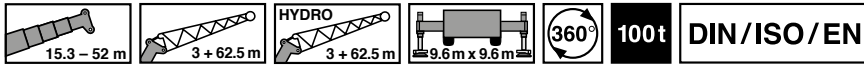



 m	15.3 m + 3.0 m + 62.5 m			42.4 m + 3.0 m + 62.5 m			47.2 m + 3.0 m + 62.5 m			52.0 m + 3.0 m + 62.5 m		
	0°	20°	40°	0°	20°	40°	0°	20°	40°	0°	20°	40°
14.0	31.3											
16.0	26.7											
18.0	23.1											
20.0	20.3											
22.0	17.9											
24.0	16.0			19.4			18.6					
26.0	14.3			18.1			18.4			14.9		
28.0	12.9			16.8			17.7			14.8		
30.0	11.7			15.6			16.3			14.4		
32.0	10.6			14.4			15.0			13.6		
34.0	9.6			13.4			14.0			13.0		
36.0	8.8	7.2		12.3			12.9			12.3		
38.0	8.1	6.6		11.5			12.1			11.2		
40.0	7.4	6.1		10.7			11.2			10.2		
42.0	6.8	5.6		10.0			10.4			9.5		
44.0	6.2	5.1		9.3	6.2		9.8	6.1		8.9		
46.0	5.6	4.8		8.7	5.7		9.1	5.8		8.4		
48.0	5.1	4.4		8.1	5.5		8.6	5.5		7.9	5.3	
50.0	4.7	4.0		7.6	5.3		8.0	5.2		7.4	5.0	
52.0	4.3	3.7		7.1	4.9		7.5	4.9		6.9	4.7	
54.0	4.0	3.4	2.7	6.7	4.5		7.1	4.6		6.5	4.5	
56.0	3.6	3.1	2.4	6.3	4.2		6.7	4.3		6.1	4.2	
58.0	3.3	2.8	2.2	5.9	3.9		6.3	4.1		5.8	4.0	
60.0	3.0	2.5	2.0	5.5	3.7	2.6	5.9	3.9	2.6	5.5	3.8	
64.0	2.5	2.1		4.9	3.3	2.3	5.2	3.5	2.3	4.9	3.4	2.3
68.0	2.0			4.1	2.9	2.0	4.2	3.1	2.1	4.0	3.0	2.0
72.0				3.2	2.6		3.0	2.8		2.9	2.7	
76.0				2.2	2.3		2.0	2.5			2.4	
80.0					2.0			2.2			2.2	
84.0								2.0				

Operation · Einsatz · Utilisation  
 Uso · Эксплуатация

Working range · Arbeitsbereich · Rayon de travail  
 Zona de trabajo · Area di lavoro · Рабочая зона

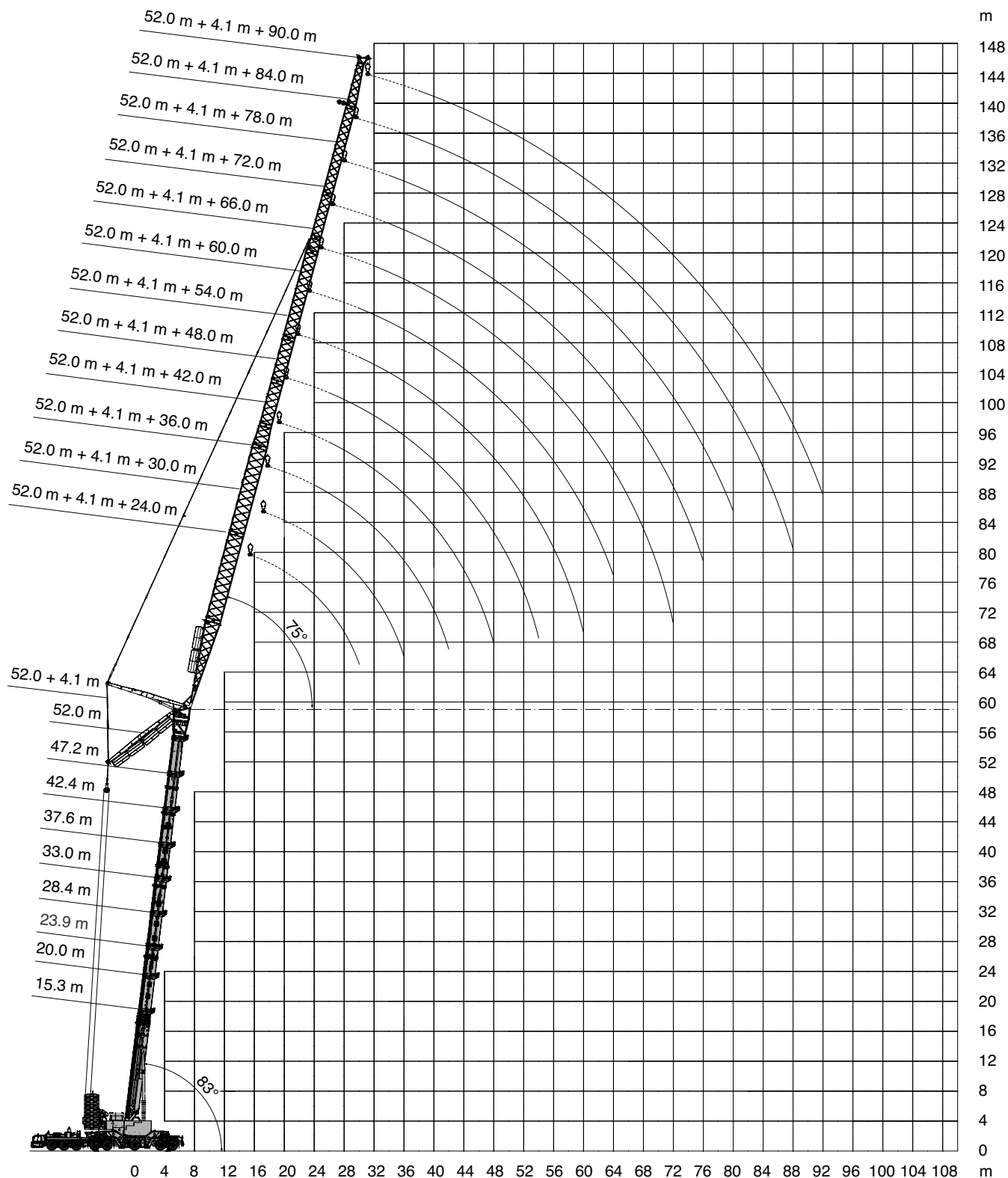
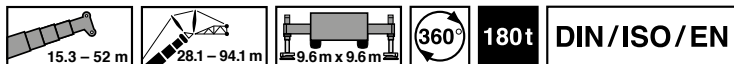

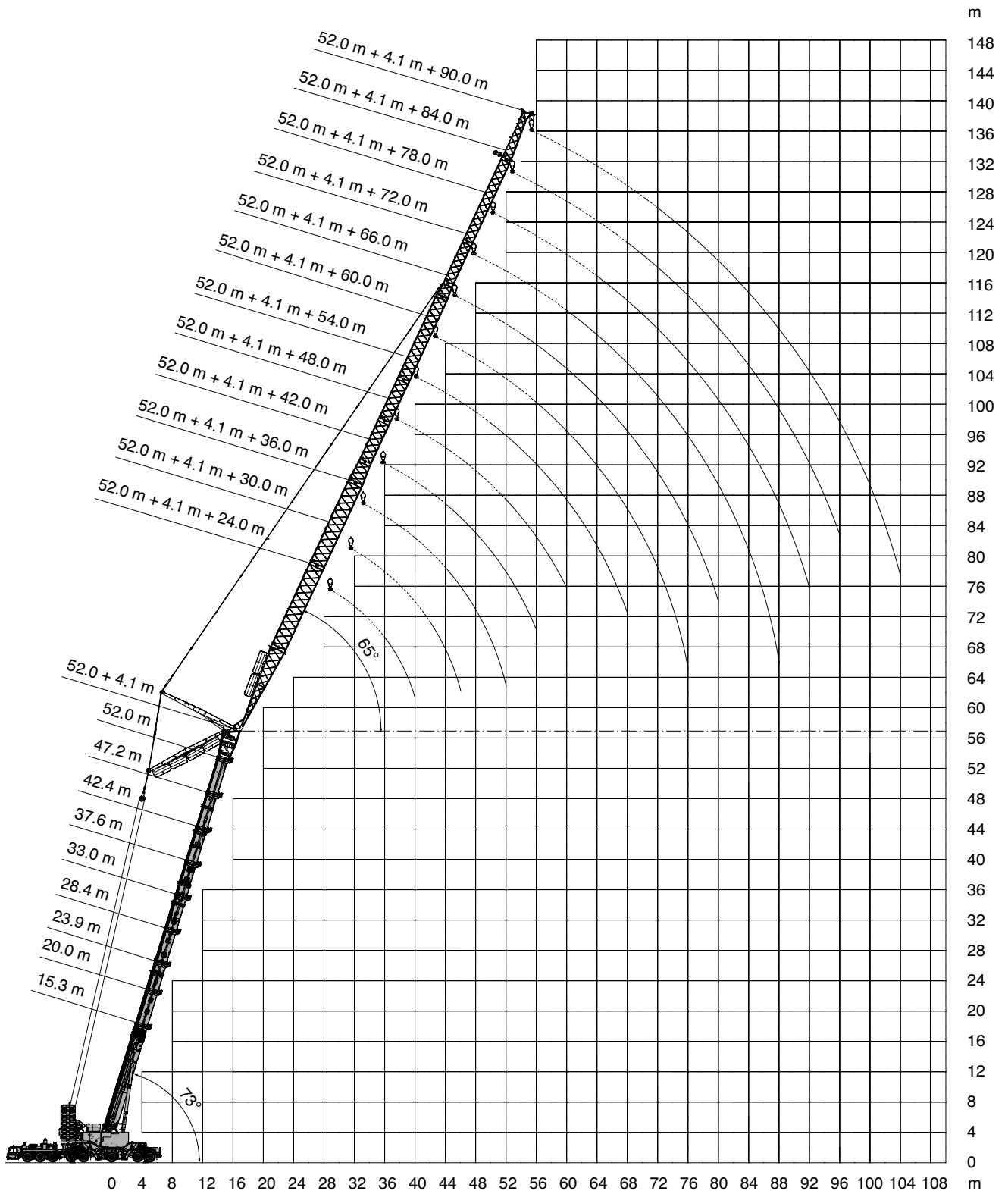
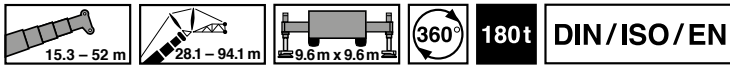

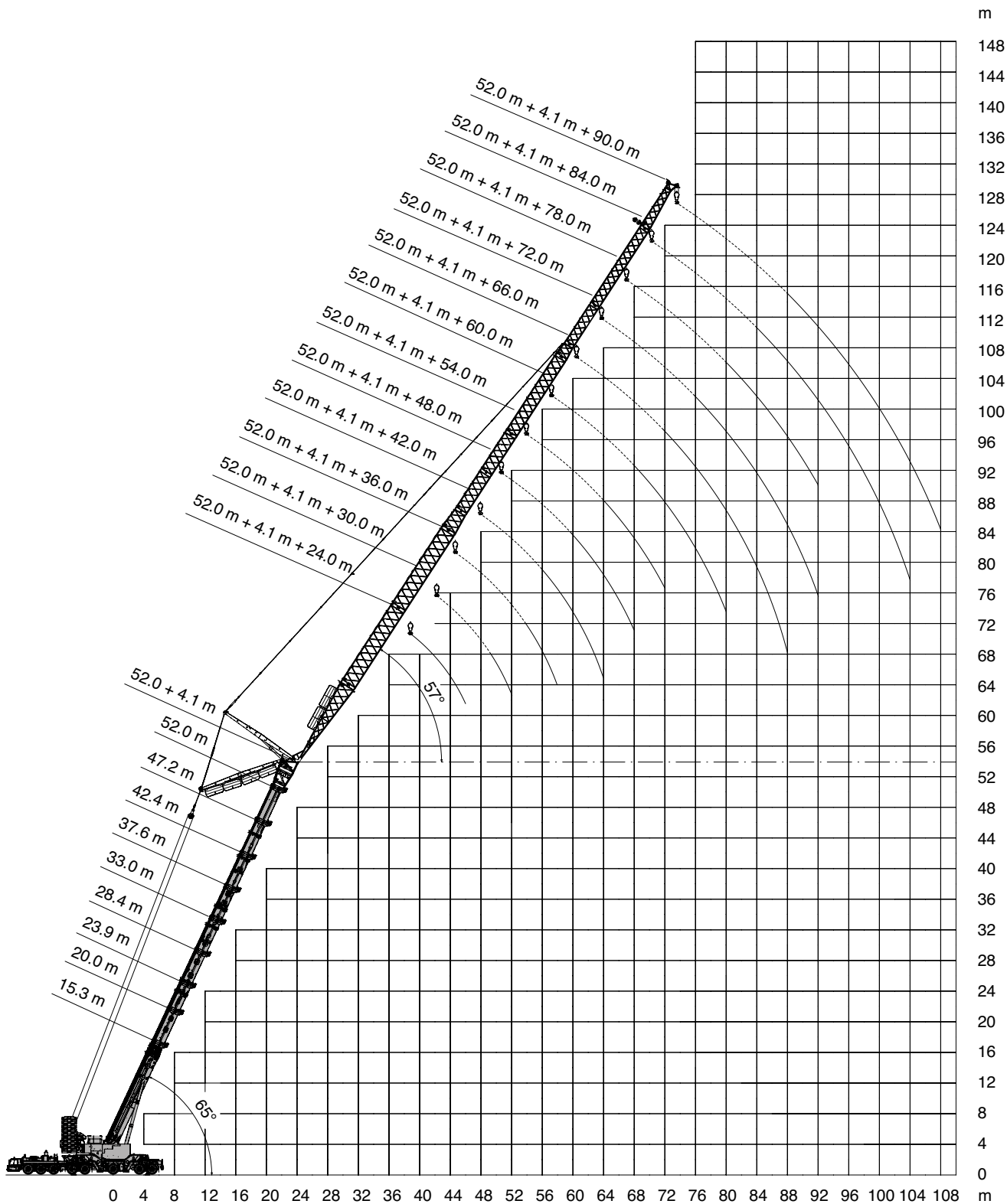
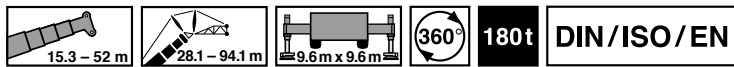

Lifting capacities · Traglasten · Charges de levage  
 Cargas · Portate · Грузоподъемность

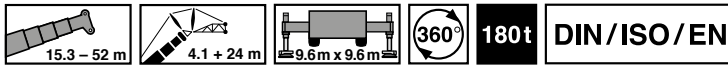

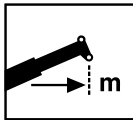
 m	15.3 m + 4.1 m + 24.0 m			23.9 m + 4.1 m + 24.0 m			33.0 m + 4.1 m + 24.0 m			42.4 m + 4.1 m + 24.0 m			52.0 m + 4.1 m + 24.0 m		
	83°	73°	65°	83°	73°	65°	83°	73°	65°	83°	73°	65°	83°	73°	65°
16.0				114.8			109.4								
18.0				103.7			107.9								
20.0		88.5		95.4			98.4			84.0					
22.0		81.7		89.1			88.7			77.7			54.9		
24.0		76.6		82.1	71.9		80.7			72.8			52.4		
26.0		72.9	68.4	74.8	67.3		73.9			68.5			50.2		
28.0		68.5	64.6		63.7		68.1	61.3		64.4			48.2		
30.0			61.9		60.6	54.8		58.0					45.5		
32.0					56.4	52.0		54.1			49.7				
34.0						49.9		50.5	44.0		47.2				
36.0									43.5		45.1			33.7	
38.0									40.7					32.7	
40.0												35.3		31.7	
42.0												33.0			

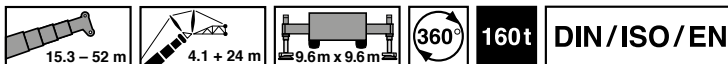

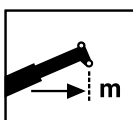
 m	15.3 m + 4.1 m + 24.0 m			23.9 m + 4.1 m + 24.0 m			33.0 m + 4.1 m + 24.0 m			42.4 m + 4.1 m + 24.0 m			52.0 m + 4.1 m + 24.0 m		
	83°	73°	65°	83°	73°	65°	83°	73°	65°	83°	73°	65°	83°	73°	65°
14.0	125.6														
16.0	112.4			114.8			109.4								
18.0	102.2			103.7			104.5								
20.0	95.1	88.5		94.8			93.2			84.0					
22.0	87.1	81.7		85.5			84.0			77.7			54.9		
24.0	77.2	76.6		77.7	71.9		76.3			72.8			52.4		
26.0	59.2	70.3	68.4	71.2	66.9		69.9			68.5			50.2		
28.0		64.8	63.0		61.6		64.4	59.0		63.3			48.2		
30.0			58.4		56.9	53.3		53.9					45.5		
32.0					52.3	48.9		49.4			47.0				
34.0						45.1		45.6	41.3		43.3				
36.0									38.2		40.1			33.7	
38.0									35.5					32.7	
40.0												30.4		31.7	
42.0												28.4			

Operation · Einsatz · Utilisation  
 Uso · Эксплуатация

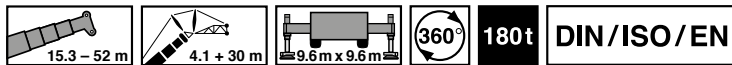

m	15.3 m + 4.1 m + 30.0 m			23.9 m + 4.1 m + 30.0 m			33.0 m + 4.1 m + 30.0 m			42.4 m + 4.1 m + 30.0 m			52.0 m + 4.1 m + 30.0 m		
	83°	73°	65°	83°	73°	65°	83°	73°	65°	83°	73°	65°	83°	73°	65°
16.0	112.9														
18.0	101.3			105.3			97.6								
20.0	92.4			95.5			97.3								
22.0	85.4	82.1		87.6			87.7			74.9					
24.0	80.0	75.7		81.1			79.7			71.0			48.0		
26.0	75.9	70.5		74.3	67.8		72.9			66.5			46.0		
28.0	69.9	66.3	64.3	68.4	63.2		67.2			62.5			44.2		
30.0	63.3	62.6	60.1	63.4	59.3		62.2	57.0		59.0			42.5		
32.0		58.3	56.6	59.0	55.4	52.2	57.9	53.0		56.3			41.1		
34.0		54.5	52.9		51.8	49.1	54.1	49.5		52.0			40.0		
36.0			49.6		48.5	46.0		46.4			44.0		37.7		
38.0					45.7	43.1		43.5	39.6		41.4				
40.0						40.3		40.7	36.9		38.6				
42.0									34.6		36.2				28.0
44.0									32.5			29.9			27.3
46.0												28.1			26.7
48.0												26.5			
50.0															22.6
52.0															21.6

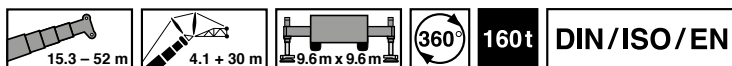

m	15.3 m + 4.1 m + 30.0 m			23.9 m + 4.1 m + 30.0 m			33.0 m + 4.1 m + 30.0 m			42.4 m + 4.1 m + 30.0 m			52.0 m + 4.1 m + 30.0 m		
	83°	73°	65°	83°	73°	65°	83°	73°	65°	83°	73°	65°	83°	73°	65°
16.0	97.1														
18.0	86.9			85.0			83.5								
20.0	78.5			76.8			75.4								
22.0	71.5	68.6		69.9			68.5			67.4					
24.0	65.5	62.8		64.0			62.7			61.6			48.0		
26.0	60.3	57.8		58.9	54.6		57.7			56.7			46.0		
28.0	55.9	53.5	51.7	54.5	50.5		53.4			52.4			44.2		
30.0	52.0	49.8	48.1	50.7	47.0		49.6	44.6		48.7			42.5		
32.0		46.5	44.9	47.3	43.8	41.0	46.3	41.6		45.4			41.1		
34.0		43.6	42.0		41.0	38.4	43.4	38.9		42.5			40.0		
36.0			39.5		38.5	36.1		36.5			34.8		37.7		
38.0					36.3	33.9		34.4	31.2		32.7				
40.0						32.0		32.4	29.4		30.8				
42.0									27.8		29.1				
44.0									26.3			24.2			27.8
46.0												23.0			26.3
48.0												21.8			24.9
50.0															19.1
52.0															18.2

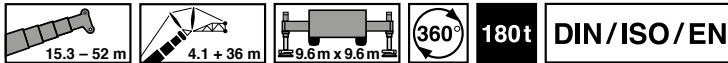

 m	15.3 m + 4.1 m + 36.0 m			23.9 m + 4.1 m + 36.0 m			33.0 m + 4.1 m + 36.0 m			42.4 m + 4.1 m + 36.0 m			52.0 m + 4.1 m + 36.0 m		
	83°	73°	65°	83°	73°	65°	83°	73°	65°	83°	73°	65°	83°	73°	65°
16.0	114.8														
18.0	103.3			108.0											
20.0	93.4			98.2			83.6								
22.0	85.4			88.5			83.6			69.8					
24.0	78.9			80.4			79.0			66.5			44.0		
26.0	73.6	71.4		73.6			72.2			63.5			42.4		
28.0	69.3	66.4		67.7			66.5			60.4			40.8		
30.0	64.1	61.9		62.7	58.8		61.5			57.6			39.1		
32.0	59.7	57.5	55.9	58.3	54.7		57.2	52.2		54.7			37.8		
34.0	55.8	53.7	52.2	54.5	51.0		53.4	48.7		51.8			36.6		
36.0	45.7	50.4	48.9	51.1	47.8	44.0	50.0	45.6		49.1			35.5		
38.0		47.4	46.0	48.1	44.9	42.3	47.0	42.7		46.1	40.5		34.4		
40.0			43.4		42.3	39.5	44.4	39.9		43.5	37.8		33.6		
42.0					39.6	37.0		37.4	33.7		35.3		29.9		
44.0						34.8		35.1	31.6		33.2			25.1	
46.0						32.8			29.8		31.2	27.2		24.4	
48.0									28.1		29.5	25.6		23.8	
50.0									26.5			24.1		23.3	
52.0												22.8		23.0	
54.0												21.6			19.7
56.0															18.7
58.0															17.7

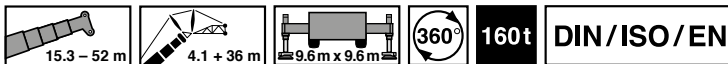

 m	15.3 m + 4.1 m + 36.0 m			23.9 m + 4.1 m + 36.0 m			33.0 m + 4.1 m + 36.0 m			42.4 m + 4.1 m + 36.0 m			52.0 m + 4.1 m + 36.0 m		
	83°	73°	65°	83°	73°	65°	83°	73°	65°	83°	73°	65°	83°	73°	65°
16.0	96.3														
18.0	86.1			84.2											
20.0	77.8			76.0			74.6								
22.0	70.8			69.1			67.8			66.6					
24.0	64.8			63.2			61.9			60.8			44.0		
26.0	59.6	57.1		58.2			56.9			55.9			42.4		
28.0	55.2	52.8		53.8			52.6			51.6			40.8		
30.0	51.3	49.0		50.0	46.2		48.9			47.9			39.1		
32.0	47.9	45.7	44.1	46.6	43.0		45.6	40.7		44.7			37.8		
34.0	44.9	42.8	41.3	43.7	40.2		42.6	38.1		41.8			36.6		
36.0	42.2	40.2	38.7	41.0	37.8	35.2	40.0	35.7		39.2			35.5		
38.0		37.9	36.5	38.7	35.5	33.1	37.7	33.6		36.9	31.8		34.4		
40.0			34.5		33.5	31.2	35.6	31.6		34.8	30.0		33.6		
42.0					31.8	29.5		29.9	26.9		28.3		29.9		
44.0						28.0		28.3	25.5		26.8			25.1	
46.0						26.6			24.1		25.4	22.1		24.1	
48.0									22.9		24.1	20.9		22.9	
50.0									21.8			19.9		21.7	
52.0												18.9		20.7	
54.0												18.0			16.3
56.0															15.3
58.0															14.5

Operation · Einsatz · Utilisation  
 Uso · Эксплуатация

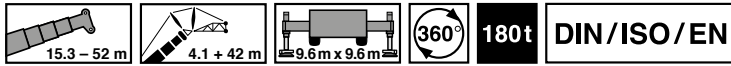

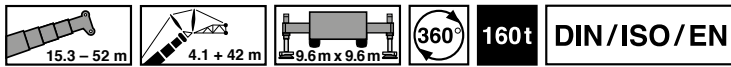

m	15.3 m + 4.1 m + 42.0 m			23.9 m + 4.1 m + 42.0 m			33.0 m + 4.1 m + 42.0 m			42.4 m + 4.1 m + 42.0 m			52.0 m + 4.1 m + 42.0 m		
	83°	73°	65°	83°	73°	65°	83°	73°	65°	83°	73°	65°	83°	73°	65°
18.0	98.5			97.6											
20.0	94.8			94.4											
22.0	86.9			88.0			79.8								
24.0	79.7			79.9			76.2			61.8					
26.0	73.9			73.0			71.7			59.2			36.8		
28.0	68.7	66.3		67.2			65.9			56.9			36.7		
30.0	63.6	61.3		62.2			61.0			54.7			36.2		
32.0	59.2	57.0		57.8	54.1		56.6			52.5			34.9		
34.0	55.3	53.2		54.0	50.4		52.8			50.4			33.7		
36.0	51.8	49.8	48.3	50.6	47.2		49.5	45.0		48.4			32.5		
38.0	48.7	46.8	45.4	47.5	44.3		46.5	42.1		45.6			31.5		
40.0	46.0	44.2	42.8	44.8	41.7	38.9	43.8	39.3		42.9	37.1		30.5		
42.0	40.1	41.8	40.3	42.4	39.0	36.4	41.2	36.7		40.2	34.7		29.7		
44.0		39.3	37.9	39.9	36.7	34.2	38.8	34.5	30.1	37.8	32.5		29.1	23.0	
46.0		37.1	35.8		34.6	32.2	36.6	32.5	29.1	35.7	30.6		28.5	22.3	
48.0			33.8		32.7	30.4		30.7	27.4		28.8		26.6	21.7	
50.0						28.7			29.0		27.2	23.4		21.1	
52.0						27.3					24.5		22.1	20.6	
54.0											23.2		24.5	20.9	20.2
56.0											22.1			19.9	19.8
58.0														18.9	17.0
60.0														18.0	16.1
64.0															14.6



m	15.3 m + 4.1 m + 42.0 m			23.9 m + 4.1 m + 42.0 m			33.0 m + 4.1 m + 42.0 m			42.4 m + 4.1 m + 42.0 m			52.0 m + 4.1 m + 42.0 m		
	83°	73°	65°	83°	73°	65°	83°	73°	65°	83°	73°	65°	83°	73°	65°
18.0	85.6			83.6											
20.0	77.2			75.4											
22.0	70.2			68.6			67.2								
24.0	64.2			62.7			61.4			60.2					
26.0	59.1			57.6			56.4			55.3			36.8		
28.0	54.6	52.2		53.2			52.1			51.1			36.7		
30.0	50.7	48.4		49.4			48.3			47.4			36.2		
32.0	47.3	45.2		46.1	42.4		45.0			44.1			34.9		
34.0	44.3	42.3		43.1	39.6		42.1			41.2			33.7		
36.0	41.6	39.7	38.1	40.5	37.2		39.5	35.0		38.6			32.5		
38.0	39.2	37.3	35.9	38.1	34.9		37.2	32.9		36.3			31.5		
40.0	37.1	35.2	33.9	36.0	32.9	30.6	35.1	31.0		34.2	29.3		30.5		
42.0	35.1	33.4	32.0	34.1	31.1	28.9	33.2	29.3		32.4	27.6		29.7		
44.0		31.6	30.4	32.3	29.5	27.4	31.4	27.7	24.8	30.7	26.1		29.1	23.0	
46.0		30.1	28.9		28.0	25.9	29.9	26.3	23.5	29.1	24.8		28.5	22.3	
48.0			27.5		26.7	24.7		25.0	22.3		23.5		26.6	21.7	
50.0						23.5		23.8	21.2		22.3	19.2		21.1	
52.0						22.4			20.2		21.3	18.2		20.0	
54.0									19.2		20.3	17.3		19.1	
56.0									18.4			16.5		18.2	14.6
58.0												15.7			13.8
60.0												14.9			13.1
64.0															11.7

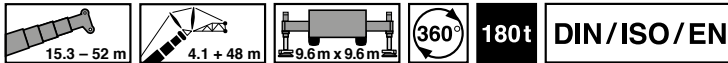



 m	15.3 m + 4.1 m + 48.0 m			23.9 m + 4.1 m + 48.0 m			33.0 m + 4.1 m + 48.0 m			42.4 m + 4.1 m + 48.0 m			52.0 m + 4.1 m + 48.0 m		
	83°	73°	65°	83°	73°	65°	83°	73°	65°	83°	73°	65°	83°	73°	65°
18.0	83.9														
20.0	79.3			80.4											
22.0	72.9			78.2			67.0								
24.0	67.2			71.6			67.0			52.6					
26.0	62.4			66.0			66.8			52.6			31.7		
28.0	58.5			61.7			65.1			52.6			31.7		
30.0	55.0	57.8		57.7			61.0			51.3			31.7		
32.0	51.7	57.0		54.2			56.7			49.5			31.6		
34.0	49.0	53.3		51.2	50.4		52.9			47.7			31.3		
36.0	46.6	49.9		48.5	47.2		49.6			46.1			30.7		
38.0	44.1	46.9	44.0	46.0	44.4		46.6	42.1		44.6			29.8		
40.0	41.5	44.2	42.8	43.4	41.8		43.9	39.3		43.0			28.9		
42.0	39.2	41.8	40.4	40.8	39.2	36.4	41.4	36.8		40.4	34.7		28.0		
44.0	37.1	39.5	38.0	38.4	36.8	34.2	39.0	34.6		38.0	32.6		27.3		
46.0	35.1	37.3	35.8	36.4	34.7	32.2	36.7	32.5		35.8	30.6		26.6		
48.0		35.3	33.9	34.6	32.8	30.4	34.8	30.7	27.4	33.8	28.9		26.1	20.6	
50.0		33.5	32.2		31.1	28.8	33.0	29.1	25.9	32.1	27.3		25.6	20.2	
52.0			30.6		29.6	27.3		27.6	24.5	30.5	25.9		24.6	19.6	
54.0					28.2	26.0		26.2	23.3		24.5	20.9	22.4	19.1	
56.0						24.8		25.0	22.1		23.3	19.9		18.7	
58.0									21.1		22.3	18.9		18.4	
60.0									20.1		21.3	18.0		18.1	16.1
64.0												16.4			14.6
68.0															13.3

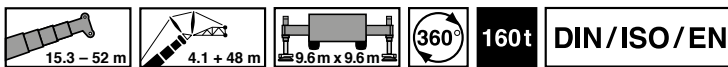

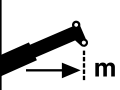
 m	15.3 m + 4.1 m + 48.0 m			23.9 m + 4.1 m + 48.0 m			33.0 m + 4.1 m + 48.0 m			42.4 m + 4.1 m + 48.0 m			52.0 m + 4.1 m + 48.0 m		
	83°	73°	65°	83°	73°	65°	83°	73°	65°	83°	73°	65°	83°	73°	65°
18.0	83.9														
20.0	77.2			75.3											
22.0	70.2			68.5			67.0								
24.0	64.2			62.6			61.3			52.6					
26.0	59.1			57.6			56.3			52.6			31.7		
28.0	54.7			53.2			52.1			51.0			31.7		
30.0	50.8	48.4		49.5			48.3			47.3			31.7		
32.0	47.4	45.2		46.1			45.0			44.1			31.6		
34.0	44.4	42.3		43.2	39.6		42.1			41.2			31.3		
36.0	41.7	39.7		40.5	37.2		39.5			38.7			30.7		
38.0	39.3	37.4	35.9	38.2	35.0		37.2	32.9		36.4			29.8		
40.0	37.1	35.3	33.9	36.0	33.0		35.1	31.0		34.3			28.9		
42.0	35.2	33.4	32.1	34.1	31.2	28.9	33.2	29.3		32.4	27.6		28.0		
44.0	33.4	31.7	30.4	32.4	29.5	27.3	31.5	27.7		30.7	26.1		27.3		
46.0	31.8	30.1	28.9	30.8	28.1	25.9	29.9	26.3		29.2	24.7		26.6		
48.0		28.7	27.5	29.4	26.7	24.7	28.5	25.0	22.2	27.8	23.5		26.1	20.6	
50.0		27.4	26.3		25.5	23.5	27.2	23.8	21.1	26.5	22.3		25.6	20.2	
52.0			25.1		24.3	22.4		22.7	20.1	25.3	21.3		24.6	19.6	
54.0					23.3	21.4		21.7	19.2		20.3	17.3	22.4	19.1	
56.0						20.5		20.8	18.4		19.4	16.5		18.2	
58.0									17.6		18.6	15.7		17.4	
60.0									16.8		17.8	14.9		16.7	13.0
64.0												13.5			11.7
68.0															10.6

Operation · Einsatz · Utilisation  
 Uso · Эксплуатация

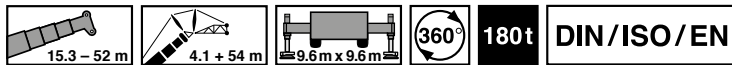

m	15.3 m + 4.1 m + 54.0 m			23.9 m + 4.1 m + 54.0 m			33.0 m + 4.1 m + 54.0 m			42.4 m + 4.1 m + 54.0 m			52.0 m + 4.1 m + 54.0 m		
	83°	73°	65°	83°	73°	65°	83°	73°	65°	83°	73°	65°	83°	73°	65°
20.0	77.1														
22.0	74.8			68.3											
24.0	72.6			68.2			57.6								
26.0	69.7			68.0			57.6			43.8					
28.0	65.0			66.2			57.6			43.8					
30.0	61.0			61.2			57.6			43.8			27.4		
32.0	57.5	56.0		56.8			55.6			43.7			27.4		
34.0	54.3	52.2		53.0			51.8			43.5			27.4		
36.0	50.9	48.8		49.6	44.0		48.5			41.8			27.3		
38.0	47.8	45.8		46.6	43.2		45.5			40.5			27.0		
40.0	45.0	43.2		43.8	40.6		42.8	38.1		39.2			26.5		
42.0	42.5	40.8	39.3	41.4	38.0		40.3	35.6		37.7			25.7		
44.0	40.2	38.3	36.9	38.9	35.7		37.8	33.4		36.8			24.9		
46.0	37.9	36.1	34.7	36.7	33.5	31.0	35.6	31.4		34.7	29.4		24.2		
48.0	35.9	34.1	32.7	34.7	31.6	29.2	33.6	29.5		32.7	27.6		23.5		
50.0	34.0	32.3	31.0	32.9	29.9	27.6	31.8	27.9		30.9	26.1		22.9	18.2	
52.0	31.8	30.7	29.4	31.2	28.4	26.1	30.2	26.4	23.3	29.3	24.6		22.4	17.7	
54.0	27.7	29.2	27.9	29.7	26.9	24.8	28.7	25.0	22.0	27.8	23.3		22.0	17.3	
56.0		27.8	26.6		25.6	23.5	27.4	23.8	20.9	26.5	22.1		21.6	16.8	
58.0			25.4		24.4	22.4		22.6	19.8	24.8	21.0	17.6	20.8	16.4	
60.0						21.4		21.6	18.8		20.0	16.7	18.9	16.0	
64.0									17.1		18.2	15.0		15.4	13.2
68.0									15.7			13.7		15.0	11.9
72.0															10.8

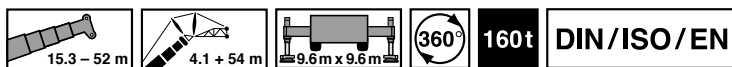

m	15.3 m + 4.1 m + 54.0 m			23.9 m + 4.1 m + 54.0 m			33.0 m + 4.1 m + 54.0 m			42.4 m + 4.1 m + 54.0 m			52.0 m + 4.1 m + 54.0 m		
	83°	73°	65°	83°	73°	65°	83°	73°	65°	83°	73°	65°	83°	73°	65°
20.0	76.1														
22.0	69.1			67.4											
24.0	63.2			61.5			57.6								
26.0	58.0			56.5			55.2			43.8					
28.0	53.6			52.2			51.0			43.8					
30.0	49.7			48.4			47.2			43.8			27.4		
32.0	46.3	44.1		45.0			43.9			43.0			27.4		
34.0	43.3	41.2		42.1			41.0			40.1			27.4		
36.0	40.6	38.6		39.5	36.0		38.4			37.6			27.3		
38.0	38.2	36.3		37.1	33.8		36.1			35.3			27.0		
40.0	36.1	34.2		35.0	31.8		34.0	29.8		33.2			26.5		
42.0	34.1	32.3	30.9	33.0	30.0		32.1	28.1		31.3			25.7		
44.0	32.3	30.6	29.3	31.3	28.4		30.4	26.5		29.6			24.9		
46.0	30.7	29.0	27.8	29.7	26.9	24.8	28.8	25.1		28.1	23.5		24.2		
48.0	29.2	27.6	26.4	28.2	25.6	23.5	27.4	23.8		26.7	22.3		23.5		
50.0	27.9	26.3	25.1	26.9	24.3	22.3	26.1	22.6		25.4	21.1		22.9	18.2	
52.0	26.6	25.1	23.9	25.7	23.2	21.2	24.9	21.5	18.9	24.2	20.1		22.4	17.7	
54.0	25.5	24.0	22.9	24.6	22.1	20.2	23.8	20.5	18.0	23.1	19.1		22.0	17.3	
56.0		23.0	21.9		21.2	19.3	22.8	19.6	17.1	22.1	18.2		21.4	16.8	
58.0			21.0		20.3	18.5		18.7	16.4	21.2	17.4	14.4	20.5	16.2	
60.0						17.7		18.0	15.6		16.6	13.6	18.9	15.4	
64.0									14.3		15.3	12.2		14.0	10.4
68.0									13.0			11.0		12.7	9.3
72.0															8.3

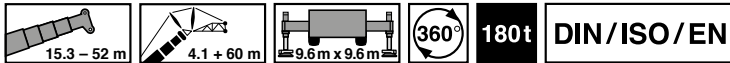

 m	15.3 m + 4.1 m + 60.0 m			23.9 m + 4.1 m + 60.0 m			33.0 m + 4.1 m + 60.0 m			42.4 m + 4.1 m + 60.0 m			52.0 m + 4.1 m + 60.0 m		
	83°	73°	65°	83°	73°	65°	83°	73°	65°	83°	73°	65°	83°	73°	65°
22.0	60.7														
24.0	60.2			53.1											
26.0	59.6			52.9			45.9								
28.0	59.1			52.6			45.9			34.5					
30.0	58.6			52.4			45.8			34.5			23.5		
32.0	57.7			52.2			45.8			34.5			23.5		
34.0	53.8			52.0			45.7			34.4			23.5		
36.0	50.3	48.2		49.0			45.7			34.4			23.5		
38.0	47.2	45.3		46.0			44.9			34.4			23.4		
40.0	44.5	42.6		43.3	40.0		42.3			34.3			23.4		
42.0	42.0	40.2		40.8	37.4		39.7	35.0		34.1			23.3		
44.0	39.6	37.8		38.3	35.1		37.2	32.7		33.9			23.2		
46.0	37.3	35.5	30.1	36.1	32.9		35.0	30.7		33.7			23.1		
48.0	35.2	33.5	30.1	34.1	31.0		33.0	28.9		32.1	27.0		23.1		
50.0	33.4	31.7	30.1	32.2	29.3	26.9	31.2	27.2		30.3	25.4		23.0		
52.0	31.7	30.0	28.8	30.5	27.7	25.4	29.6	25.7		28.7	23.9		22.7	18.8	
54.0	30.1	28.5	27.3	29.0	26.3	24.1	28.1	24.4	21.3	27.2	22.6		22.2	18.3	
56.0	28.7	27.1	25.9	27.6	25.0	22.9	26.7	23.1	20.2	25.8	21.4		21.7	17.7	
58.0	27.3	25.9	24.7	26.4	23.8	21.7	25.4	21.9	19.1	24.6	20.3		21.3	17.2	
60.0		24.7	23.6	25.2	22.7	20.7	24.3	20.9	18.1	23.5	19.3	15.9	21.0	16.7	
64.0			21.6		20.7	18.8		19.0	16.4		17.5	14.3	19.0	15.9	
68.0						17.3			17.5			16.0	12.9	14.6	11.2
72.0												14.7	11.8	13.4	10.1
76.0													10.8	12.4	9.1
80.0															8.3

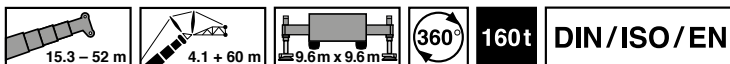

 m	15.3 m + 4.1 m + 60.0 m			23.9 m + 4.1 m + 60.0 m			33.0 m + 4.1 m + 60.0 m			42.4 m + 4.1 m + 60.0 m			52.0 m + 4.1 m + 60.0 m		
	83°	73°	65°	83°	73°	65°	83°	73°	65°	83°	73°	65°	83°	73°	65°
22.0	60.7														
24.0	60.2			53.1											
26.0	57.5			52.9			45.9								
28.0	53.0			51.6			45.9			34.5					
30.0	49.2			47.8			45.8			34.5			23.5		
32.0	45.8			44.5			43.4			34.5			23.5		
34.0	42.8			41.5			40.5			34.4			23.5		
36.0	40.1	38.0		38.9			37.9			34.4			23.5		
38.0	37.7	35.7		36.5			35.5			34.4			23.4		
40.0	35.5	33.6		34.4	31.2		33.4			32.6			23.4		
42.0	33.5	31.7		32.5	29.4		31.5	27.4		30.7			23.3		
44.0	31.7	30.0		30.7	27.8		29.8	25.9		29.0			23.2		
46.0	30.1	28.4	27.1	29.1	26.3		28.2	24.5		27.5			23.1		
48.0	28.6	27.0	25.8	27.7	25.0		26.8	23.2		26.1	21.6		23.1		
50.0	27.3	25.7	24.5	26.3	23.7	21.7	25.5	22.0		24.8	20.5		23.0		
52.0	26.0	24.5	23.3	25.1	22.6	20.6	24.3	20.9		23.6	19.4		22.7	18.1	
54.0	24.9	23.4	22.2	24.0	21.5	19.6	23.2	19.9	17.3	22.4	18.4		21.8	17.2	
56.0	23.8	22.3	21.2	22.9	20.5	18.7	22.1	18.9	16.5	21.4	17.5		20.8	16.3	
58.0	22.8	21.4	20.3	22.0	19.6	17.8	21.2	18.1	15.7	20.5	16.7		19.9	15.5	
60.0		20.5	19.5	21.1	18.8	17.0	20.3	17.3	14.9	19.6	15.9	12.8	19.0	14.8	
64.0			18.0		17.3	15.6		15.9	13.5		14.6	11.4	17.5	13.2	
68.0						14.5			14.7			13.3	10.2	11.9	8.5
72.0												12.2	9.2	10.8	7.5
76.0													8.4	10.0	6.7
80.0															6.1

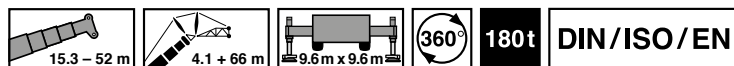

 m	15.3 m + 4.1 m + 66.0 m			23.9 m + 4.1 m + 66.0 m			33.0 m + 4.1 m + 66.0 m			42.4 m + 4.1 m + 66.0 m			52.0 m + 4.1 m + 66.0 m		
	83°	73°	65°	83°	73°	65°	83°	73°	65°	83°	73°	65°	83°	73°	65°
24.0	42.0														
26.0	42.0			40.1											
28.0	42.0			39.9			35.3								
30.0	42.0			39.6			35.1			28.9					
32.0	42.0			39.4			35.0			28.8			17.6		
34.0	41.8			39.1			34.9			28.8			17.6		
36.0	41.5			38.9			34.7			28.7			17.6		
38.0	41.2	40.2		38.6			34.6			28.7			17.5		
40.0	40.0	39.9		38.3			34.5			28.7			17.5		
42.0	38.5	39.4		38.1	36.6		34.3			28.6			17.4		
44.0	37.0	37.0		37.1	34.2		34.1			28.5			17.4		
46.0	35.6	34.7		35.3	32.1		34.0	29.8		28.3			17.2		
48.0	34.0	32.7	30.1	33.2	30.2		32.2	28.0		28.2			17.0		
50.0	32.6	30.9	29.5	31.4	28.5		30.4	26.4		28.0	24.5		16.8		
52.0	30.8	29.2	27.9	29.7	26.9	24.6	28.7	24.9		27.8	23.0		16.6		
54.0	29.3	27.7	26.4	28.2	25.4	23.2	27.2	23.5		26.4	21.7		16.3	17.3	
56.0	27.8	26.3	25.1	26.8	24.1	22.0	25.8	22.2		25.0	20.5		16.1	17.0	
58.0	26.5	25.0	23.8	25.5	22.9	20.8	24.6	21.1	18.2	23.7	19.4		15.9	16.6	
60.0	25.3	23.8	22.7	24.3	21.8	19.8	23.4	20.0	17.2	22.6	18.4		15.7	15.8	
64.0		21.8	20.7	22.2	19.8	17.9	21.3	18.1	15.5	19.7	16.6	13.4	15.3	15.1	
68.0			19.0		18.1	16.3	19.6	16.5	14.0	15.4	15.0	12.0	14.8	13.7	
72.0						15.0		15.1	12.7		13.7	10.8	14.4	12.4	9.1
76.0									11.7		12.6	9.8		11.3	8.1
80.0												8.9		10.4	7.3
84.0															6.6
88.0															6.0

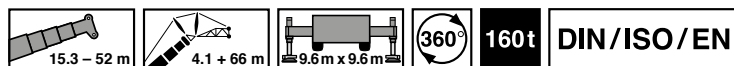

 m	15.3 m + 4.1 m + 66.0 m			23.9 m + 4.1 m + 66.0 m			33.0 m + 4.1 m + 66.0 m			42.4 m + 4.1 m + 66.0 m			52.0 m + 4.1 m + 66.0 m		
	83°	73°	65°	83°	73°	65°	83°	73°	65°	83°	73°	65°	83°	73°	65°
24.0	42.3														
26.0	42.3			40.1											
28.0	42.3			39.9			35.3								
30.0	42.3			39.6			35.1			28.9					
32.0	42.2			39.4			35.0			28.8			17.6		
34.0	41.8			39.1			34.9			28.8			17.6		
36.0	39.3			38.1			34.7			28.8			17.6		
38.0	36.9	34.9		35.7			34.6			28.7			17.5		
40.0	34.7	32.8		33.6			32.6			28.7			17.5		
42.0	32.8	30.9		31.7	28.6		30.8			28.6			17.4		
44.0	31.0	29.2		29.9	27.0		29.0			28.2			17.4		
46.0	29.3	27.6		28.3	25.5		27.5	23.6		26.7			17.2		
48.0	27.8	26.2	24.9	26.9	24.1		26.0	22.3		25.2			17.0		
50.0	26.5	24.9	23.7	25.5	22.9		24.7	21.1		23.9	19.6		16.8		
52.0	25.2	23.7	22.5	24.3	21.7	19.7	23.5	20.0		22.7	18.5		16.6		
54.0	24.0	22.6	21.4	23.1	20.7	18.7	22.3	19.0		21.6	17.6		16.3	16.3	
56.0	23.0	21.5	20.4	22.1	19.7	17.8	21.3	18.1		20.6	16.7		16.1	15.4	
58.0	22.0	20.6	19.5	21.1	18.8	17.0	20.3	17.2	14.8	19.7	15.8		15.9	14.6	
60.0	21.1	19.7	18.6	20.2	17.9	16.2	19.5	16.4	14.0	18.8	15.1		15.7	13.8	
64.0		18.1	17.1	18.6	16.4	14.8	17.9	15.0	12.6	17.2	13.7	10.5	15.3	12.3	
68.0			15.8		15.1	13.5	16.6	13.7	11.3	15.4	12.3	9.3	14.8	11.0	
72.0						12.4			12.6		10.2	8.3	14.2	9.9	6.5
76.0									9.3		10.2	7.4		8.9	5.7
80.0												6.6		8.1	5.0
84.0															4.4
88.0															4.0

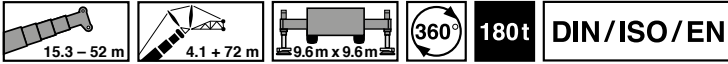

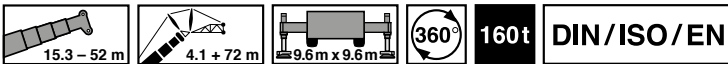

 m	15.3 m + 4.1 m + 72.0 m			23.9 m + 4.1 m + 72.0 m			33.0 m + 4.1 m + 72.0 m			42.4 m + 4.1 m + 72.0 m			52.0 m + 4.1 m + 72.0 m			
	83°	73°	65°	83°	73°	65°	83°	73°	65°	83°	73°	65°	83°	73°	65°	
26.0	35.6															
28.0	35.1			32.9												
30.0	34.7			32.6			29.3									
32.0	34.3			32.3			29.2			24.4						
34.0	33.8			32.0			29.0			24.4				15.1		
36.0	33.4			31.7			28.9			24.3				15.1		
38.0	33.0			31.4			28.7			24.3				15.1		
40.0	32.5			31.1			28.6			24.2				15.1		
42.0	32.1	31.7		30.8			28.4			24.2				15.0		
44.0	31.7	31.4		30.5	29.6		28.2			24.1				15.0		
46.0	31.3	31.0		30.2	29.4		28.0			24.0				15.0		
48.0	30.9	30.7		29.9	29.2		27.8	24.6		23.9				15.0		
50.0	30.3	30.3		29.6	27.9		27.6	24.6		23.8				14.8		
52.0	29.1	28.7	27.4	29.2	26.3		27.4	24.3		23.7	20.8			14.7		
54.0	28.0	27.1	25.9	27.6	24.9		26.7	22.9		23.6	20.8			14.5		
56.0	27.0	25.7	24.5	26.2	23.5	21.3	25.3	21.6		23.5	19.9			14.4		
58.0	26.0	24.5	23.3	24.9	22.3	20.2	24.0	20.5		23.2	18.8			14.3		
60.0	24.7	23.3	22.1	23.7	21.2	19.2	22.8	19.4	16.6	22.0	17.7			14.1	14.6	
64.0	22.6	21.2	20.1	21.6	19.2	17.3	20.7	17.5	14.8	19.9	15.9			13.9	14.1	
68.0	20.8	19.4	18.3	19.8	17.5	15.7	18.9	15.8	13.3	18.2	14.4	11.3		13.6	13.0	
72.0		17.8	16.8	18.3	16.0	14.3	17.4	14.4	12.1	16.7	13.0	10.1		13.3	11.7	
76.0			15.6		14.8	13.1		13.2	11.0	15.4	11.9	9.1		12.9	10.6	7.4
80.0									12.3	10.0		10.9	8.2		9.6	6.6
84.0												10.1	7.4		8.8	5.8
88.0													6.8		8.2	5.2
92.0																4.7



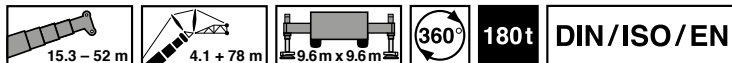

 m	15.3 m + 4.1 m + 72.0 m			23.9 m + 4.1 m + 72.0 m			33.0 m + 4.1 m + 72.0 m			42.4 m + 4.1 m + 72.0 m			52.0 m + 4.1 m + 72.0 m			
	83°	73°	65°	83°	73°	65°	83°	73°	65°	83°	73°	65°	83°	73°	65°	
26.0	35.6															
28.0	35.1			32.9												
30.0	34.7			32.6			29.3									
32.0	34.3			32.3			29.2			24.4						
34.0	33.8			32.0			29.0			24.4				15.1		
36.0	33.4			31.7			28.9			24.3				15.1		
38.0	33.0			31.4			28.7			24.3				15.1		
40.0	32.5			31.1			28.6			24.2				15.1		
42.0	32.1	30.3		30.8			28.4			24.2				15.0		
44.0	30.4	28.6		29.4	26.4		28.2			24.1				15.0		
46.0	28.8	27.1		27.8	24.9		26.9			24.1				15.0		
48.0	27.3	25.6		26.3	23.5		25.5	21.7		24.0				15.0		
50.0	25.9	24.3		25.0	22.3		24.1	20.5		23.4				14.8		
52.0	24.7	23.1	21.9	23.7	21.1		22.9	19.4		22.2	17.9			14.7		
54.0	23.5	22.0	20.8	22.6	20.1		21.8	18.4		21.1	16.9			14.5		
56.0	22.4	21.0	19.8	21.5	19.1	17.2	20.7	17.5		20.0	16.0			14.4		
58.0	21.4	20.0	18.9	20.5	18.2	16.3	19.8	16.6		19.1	15.2			14.3		
60.0	20.5	19.1	18.0	19.6	17.3	15.6	18.9	15.8	13.4	18.2	14.4			14.1	13.2	
64.0	18.8	17.5	16.5	18.0	15.8	14.1	17.3	14.4	11.9	16.6	13.0			13.9	11.6	
68.0	17.4	16.1	15.2	16.6	14.5	12.9	15.9	13.1	10.6	15.2	11.7	8.6		13.6	10.3	
72.0		14.9	14.0	15.4	13.4	11.8	14.7	11.9	9.5	14.1	10.5	7.6		13.3	9.2	
76.0			13.0		12.4	10.7		10.9	8.6	13.1	9.5	6.7		12.4	8.2	5.0
80.0									10.0			8.6	5.9		7.4	4.3
84.0												7.9	5.3		6.7	3.7
88.0													4.7		6.2	3.2
92.0																2.8

Operation · Einsatz · Utilisation  
 Uso · Эксплуатация

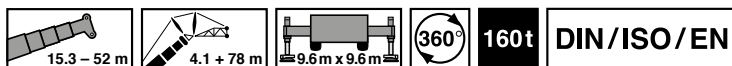

 m	15.3 m + 4.1 m + 78.0 m			23.9 m + 4.1 m + 78.0 m			33.0 m + 4.1 m + 78.0 m			42.4 m + 4.1 m + 78.0 m			52.0 m + 4.1 m + 78.0 m		
	83°	73°	65°	83°	73°	65°	83°	73°	65°	83°	73°	65°	83°	73°	65°
26.0	26.0														
28.0	25.7			24.1											
30.0	25.4			23.9			21.5								
32.0	25.1			23.6			21.4			18.1					
34.0	24.8			23.4			21.2			18.0			12.8		
36.0	24.5			23.2			21.1			17.9			12.8		
38.0	24.3			23.0			20.9			17.8			12.7		
40.0	24.0			22.8			20.8			17.7			12.7		
42.0	23.7	23.5		22.6			20.6			17.6			12.7		
44.0	23.5	23.3		22.4			20.5			17.5			12.7		
46.0	23.2	23.1		22.2	21.9		20.3			17.4			12.6		
48.0	23.0	22.9		22.0	21.8		20.2			17.3			12.6		
50.0	22.8	22.7		21.8	21.7		20.0	19.8		17.2			12.6		
52.0	22.5	22.5		21.6	21.5		19.8	19.8		17.0			12.5		
54.0	22.3	22.3		21.4	21.4		19.7	19.8		16.9			12.4		
56.0	22.1	22.2	21.6	21.2	21.3		19.5	19.8		16.7	17.0		12.4		
58.0	21.8	22.0	21.5	21.0	21.2		19.3	19.6		16.6	17.0		12.3		
60.0	21.6	21.8	21.3	20.8	20.4	18.3	19.2	18.5		16.4	16.8		12.2		
64.0	21.1	20.3	19.2	20.4	18.3	16.4	18.8	16.6		16.1	15.0		12.0	12.3	
68.0	19.8	18.5	17.4	18.9	16.6	14.8	18.1	15.0	12.4	15.8	13.5		11.8	11.8	
72.0	18.3	16.9	15.9	17.3	15.1	13.4	16.5	13.5	11.1	15.5	12.1	9.1	11.7	10.8	
76.0		15.6	14.6	16.0	13.8	12.2	14.5	12.3	10.0	14.4	10.9	8.1	11.5	9.7	
80.0			13.5		12.7	11.1		11.2	9.0	13.3	9.9	7.2	11.3	8.7	5.6
84.0						10.2		10.4	8.2		9.0	6.4		7.8	4.8
88.0									7.5		8.3	5.7		7.1	4.2
92.0												5.2		6.5	3.7
96.0															3.2



 m	15.3 m + 4.1 m + 78.0 m			23.9 m + 4.1 m + 78.0 m			33.0 m + 4.1 m + 78.0 m			42.4 m + 4.1 m + 78.0 m			52.0 m + 4.1 m + 78.0 m		
	83°	73°	65°	83°	73°	65°	83°	73°	65°	83°	73°	65°	83°	73°	65°
26.0	26.0														
28.0	25.7			24.1											
30.0	25.4			23.9			21.5								
32.0	25.1			23.7			21.4			18.1					
34.0	24.8			23.4			21.2			18.0			12.8		
36.0	24.5			23.2			21.1			17.9			12.8		
38.0	24.3			23.0			20.9			17.8			12.7		
40.0	24.0			22.8			20.8			17.7			12.7		
42.0	23.7	23.5		22.6			20.6			17.6			12.7		
44.0	23.5	23.3		22.4			20.5			17.5			12.7		
46.0	23.3	23.1		22.2	21.9		20.3			17.5			12.6		
48.0	23.0	22.9		22.0	21.8		20.2			17.3			12.6		
50.0	22.8	22.7		21.8	21.5		20.0	19.7		17.2			12.6		
52.0	22.6	22.3		21.6	20.3		19.8	18.6		17.0			12.5		
54.0	22.3	21.2		21.4	19.3		19.7	17.6		16.9			12.4		
56.0	21.6	20.1	19.0	20.7	18.3		19.5	16.6		16.7	15.2		12.4		
58.0	20.6	19.2	18.1	19.8	17.4		19.0	15.8		16.6	14.3		12.3		
60.0	19.7	18.3	17.2	18.8	16.5	14.7	18.1	15.0		16.4	13.6		12.2		
64.0	18.0	16.7	15.7	17.2	15.0	13.3	16.5	13.5		15.8	12.1		12.0	10.7	
68.0	16.6	15.3	14.3	15.8	13.7	12.0	15.1	12.2	9.7	14.4	10.8		11.8	9.4	
72.0	15.3	14.1	13.1	14.5	12.5	10.8	13.8	11.0	8.6	13.2	9.6	6.6	11.7	8.3	
76.0		13.0	12.1	13.5	11.4	9.8	12.8	9.9	7.6	12.0	8.5	5.7	11.4	7.3	
80.0			11.2		10.5	8.9		9.0	6.8	11.1	7.6	4.9	10.4	6.4	3.3
84.0						8.1			8.2		6.1	4.3		5.7	2.7
88.0											5.4	3.7		5.1	2.2
92.0												3.2		4.6	

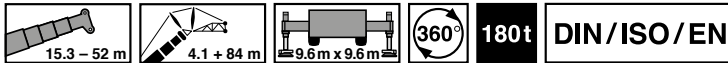

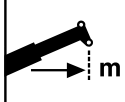

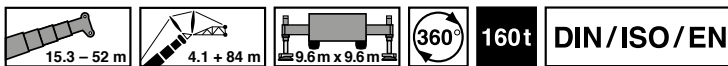
 m	15.3 m + 4.1 m + 84.0 m			23.9 m + 4.1 m + 84.0 m			33.0 m + 4.1 m + 84.0 m			42.4 m + 4.1 m + 84.0 m			52.0 m + 4.1 m + 84.0 m		
	83°	73°	65°	83°	73°	65°	83°	73°	65°	83°	73°	65°	83°	73°	65°
28.0	21.4														
30.0	21.1			20.0											
32.0	20.8			19.8			18.1								
34.0	20.5			19.6			17.9			15.4					
36.0	20.3			19.4			17.8			15.4				11.1	
38.0	20.0			19.2			17.7			15.3				11.1	
40.0	19.7			19.0			17.5			15.2				11.1	
42.0	19.5			18.7			17.4			15.1				11.0	
44.0	19.2			18.5			17.3			15.1				11.0	
46.0	18.9	18.9		18.3			17.1			15.0				11.0	
48.0	18.7	18.7		18.1			17.0			14.9				11.0	
50.0	18.5	18.4		17.9	17.7		16.8			14.9				11.0	
52.0	18.2	18.2		17.7	17.6		16.7			14.8				11.0	
54.0	18.0	18.0		17.5	17.4		16.5	16.3		14.7				10.9	
56.0	17.8	17.8		17.3	17.3		16.4	16.3		14.5				10.9	
58.0	17.5	17.6		17.1	17.1		16.2	16.2		14.4	14.3			10.8	
60.0	17.3	17.4	17.1	16.9	17.0		16.1	16.1		14.3	14.3			10.8	
64.0	16.8	17.0	16.8	16.5	16.7	16.1	15.8	16.0		14.1	14.3			10.7	
68.0	16.3	16.6	16.5	16.1	16.4	14.6	15.5	14.7		13.9	13.2			10.6	10.5
72.0	15.9	16.2	15.7	15.7	14.9	13.1	15.2	13.3	10.9	13.7	11.9			10.5	10.5
76.0	15.4	15.3	14.4	15.3	13.6	11.9	14.8	12.1	9.8	13.5	10.7	7.8		10.4	9.4
80.0	14.9	14.1	13.2	14.5	12.5	10.9	13.7	11.0	8.8	13.0	9.6	6.9		10.3	8.4
84.0		13.1	12.2		11.5	9.9	12.7	10.0	7.9	12.0	8.7	6.1		10.1	7.5
88.0					10.7	9.1		9.2	7.2		7.9	5.4		9.4	6.8
92.0						8.5			6.5		7.3	4.8		6.1	3.7
96.0									6.0			4.3		5.6	3.3
100.0												3.9			2.9
104.0															2.5

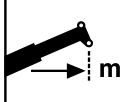

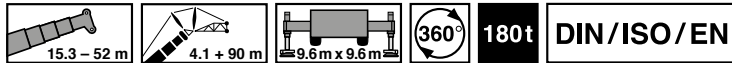

 m	15.3 m + 4.1 m + 84.0 m			23.9 m + 4.1 m + 84.0 m			33.0 m + 4.1 m + 84.0 m			42.4 m + 4.1 m + 84.0 m			52.0 m + 4.1 m + 84.0 m		
	83°	73°	65°	83°	73°	65°	83°	73°	65°	83°	73°	65°	83°	73°	65°
28.0	21.4														
30.0	21.1			20.0											
32.0	20.8			19.8			18.1								
34.0	20.5			19.6			17.9			15.4					
36.0	20.3			19.4			17.8			15.4				11.1	
38.0	20.0			19.2			17.7			15.3				11.1	
40.0	19.7			19.0			17.5			15.2				11.1	
42.0	19.5			18.7			17.4			15.1				11.0	
44.0	19.2			18.5			17.3			15.1				11.0	
46.0	18.9	18.9		18.3			17.1			15.0				11.0	
48.0	18.7	18.7		18.1			17.0			14.9				11.0	
50.0	18.5	18.4		17.9	17.7		16.8			14.9				11.0	
52.0	18.2	18.2		17.7	17.6		16.7			14.8				11.0	
54.0	18.0	18.0		17.5	17.4		16.5	16.3		14.7				10.9	
56.0	17.8	17.8		17.3	17.3		16.4	16.3		14.5				10.9	
58.0	17.5	17.6		17.1	17.1		16.2	15.5		14.4	14.1			10.8	
60.0	17.3	17.4	17.0	16.9	16.3		16.1	14.7		14.3	13.3			10.8	
64.0	16.8	16.5	15.4	16.5	14.8	13.0	15.8	13.3		14.1	11.9			10.7	
68.0	16.3	15.1	14.1	15.6	13.4	11.8	14.8	12.0		13.9	10.5			10.6	9.2
72.0	15.1	13.8	12.9	14.3	12.3	10.6	13.6	10.8	8.3	13.0	9.3			10.5	8.0
76.0	14.0	12.8	11.8	13.2	11.2	9.5	12.5	9.7	7.4	11.8	8.3	5.4		10.4	7.0
80.0	13.0	11.8	10.9	12.3	10.2	8.6	11.5	8.7	6.5	10.8	7.4	4.7		10.1	6.1
84.0		11.0	10.1		9.3	7.8	10.6	7.9	5.8	9.9	6.6	4.0		9.2	5.4
88.0					8.6	7.1		7.2	5.1		5.9	3.4		8.5	4.7
92.0						6.5			4.6		5.3	2.9		4.2	4.2
96.0									4.2			2.5		3.7	3.7
100.0												2.1			

Operation · Einsatz · Utilisation  
 Uso · Эксплуатация

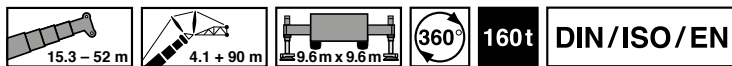

 m	15.3 m + 4.1 m + 90.0 m			23.9 m + 4.1 m + 90.0 m			33.0 m + 4.1 m + 90.0 m			42.4 m + 4.1 m + 90.0 m			52.0 m + 4.1 m + 90.0 m		
	83°	73°	65°	83°	73°	65°	83°	73°	65°	83°	73°	65°	83°	73°	65°
32.0	17.4			16.6											
34.0	17.2			16.4			15.1								
36.0	16.9			16.2			15.0			13.0					
38.0	16.7			16.0			14.9			13.0			9.4		
40.0	16.4			15.8			14.7			12.9			9.4		
42.0	16.2			15.6			14.6			12.8			9.4		
44.0	15.9			15.4			14.5			12.8			9.4		
46.0	15.6			15.2			14.3			12.7			9.4		
48.0	15.4	15.4		15.0			14.2			12.6			9.4		
50.0	15.2	15.2		14.8			14.1			12.6			9.4		
52.0	15.0	15.0		14.6	14.5		13.9			12.5			9.4		
54.0	14.7	14.7		14.4	14.3		13.8			12.4			9.4		
56.0	14.5	14.5		14.3	14.2		13.6			12.3			9.4		
58.0	14.3	14.3		14.1	14.0		13.5	13.3		12.2			9.3		
60.0	14.1	14.1		13.9	13.8		13.3	13.2		12.1			9.3		
64.0	13.7	13.7	13.6	13.5	13.5		13.1	13.0		11.9	11.8		9.2		
68.0	13.2	13.3	13.2	13.1	13.2		12.8	12.9		11.7	11.8		9.2		
72.0	12.8	13.0	12.9	12.7	12.9	12.7	12.5	12.7		11.6	11.7		9.1	8.8	
76.0	12.4	12.6	12.6	12.4	12.6	11.8	12.2	12.2	10.0	11.4	11.1		9.0	8.7	
80.0	11.9	12.3	12.3	12.0	12.3	10.8	11.9	11.1	9.0	11.2	10.0	7.4	8.9	8.4	
84.0	11.5	11.9	11.7	11.6	11.3	9.8	11.6	10.1	8.1	11.0	9.1	6.6	8.9	7.9	
88.0		11.5	10.7	11.2	10.3	8.9	11.3	9.2	7.3	10.8	8.2	5.9	8.8	7.4	4.6
92.0			9.9		9.5	8.1		8.4	6.6	10.3	7.5	5.2	7.7	6.6	4.0
96.0						7.4		7.7	5.9		6.8	4.6		6.0	3.4
100.0									5.3		6.1	4.0		5.3	2.9
104.0												3.5		4.7	2.4
108.0															2.0



 m	15.3 m + 4.1 m + 90.0 m			23.9 m + 4.1 m + 90.0 m			33.0 m + 4.1 m + 90.0 m			42.4 m + 4.1 m + 90.0 m			52.0 m + 4.1 m + 90.0 m		
	83°	73°	65°	83°	73°	65°	83°	73°	65°	83°	73°	65°	83°	73°	65°
32.0	17.4			16.6											
34.0	17.2			16.4			15.1								
36.0	16.9			16.2			15.0			13.0					
38.0	16.7			16.0			14.9			13.0			9.4		
40.0	16.4			15.8			14.7			12.9			9.4		
42.0	16.2			15.6			14.6			12.8			9.4		
44.0	15.9			15.4			14.5			12.8			9.4		
46.0	15.6			15.2			14.3			12.7			9.4		
48.0	15.4	15.4		15.0			14.2			12.6			9.4		
50.0	15.2	15.2		14.8			14.1			12.6			9.4		
52.0	15.0	15.0		14.6	14.5		13.9			12.5			9.4		
54.0	14.7	14.7		14.4	14.3		13.8			12.4			9.4		
56.0	14.5	14.5		14.3	14.2		13.6			12.3			9.4		
58.0	14.3	14.3		14.1	14.0		13.5	13.3		12.2			9.3		
60.0	14.1	14.1		13.9	13.8		13.3	13.2		12.1			9.3		
64.0	13.7	13.7	13.6	13.5	13.5		13.1	12.7		11.9	11.3		9.2		
68.0	13.2	13.3	13.2	13.1	12.8		12.8	11.4		11.7	9.9		9.2		
72.0	12.8	13.0	12.3	12.7	11.7	10.0	12.5	10.2		11.6	8.7		9.1	7.3	
76.0	12.4	12.1	11.2	12.4	10.6	8.9	11.9	9.0	6.7	11.2	7.6		9.0	6.3	
80.0	11.9	11.2	10.3	11.6	9.5	7.9	10.8	8.1	5.8	10.1	6.7	4.0	8.9	5.5	
84.0	11.5	10.3	9.4	10.7	8.7	7.1	9.9	7.2	5.1	9.2	5.9	3.3	8.5	4.7	
88.0		9.5	8.6	9.9	7.9	6.4	9.1	6.5	4.4	8.4	5.2	2.7	7.8	4.0	
92.0			7.9		7.3	5.8		5.9	3.9	7.8	4.6	2.2	7.1	3.5	
96.0						5.3		5.4	3.4		4.1			3.0	
100.0									3.0		3.7			2.6	
104.0														2.3	



# ADDITIONAL INFORMATION

ZUSATZINFORMATIONEN  
INFORMATIONS SUPPLÉMENTAIRES  
INFORMACIÓN ADICIONAL  
ALTRE INFORMAZIONI  
ДОПОЛНИТЕЛЬНАЯ ИНФОРМАЦИЯ



## Additional information · Zusatzinformationen · Informations supplémentaires

### Remarks relating to the capacity charts · Anmerkungen zu den Traglasttabellen Remarques relatives aux tableaux des charges

1. The lifting capacities in the structural area are based on EN 13000.
2. The lifting capacities in the stability area are based on ISO 4305 / EN 13000.
3. Depending on the boom length, with the lifting capacity charts, wind speeds up to max. 13.3 m/s are admissible. Due to the different extension sequences of the various telescopes, the boom lengths may differ slightly from those indicated in the lifting capacity charts.
4. The lifting capacities are shown in metric tons.
5. The weight of load handling devices such as hook blocks, slings, etc., must be considered as part of the load and must be deducted from the lifting capacities.
6. The lifting capacities for the telescopic boom apply to a crane with no jib being stowed or mounted on the crane.
7. The working radius is the horizontal distance from the centre of rotation to the centre of the freely suspended non-oscillating load.

1. Die Tragfähigkeiten im Festigkeitsbereich basieren auf EN 13000.
2. Die Tragfähigkeiten im Standsicherheitsbereich entsprechen ISO 4305 / EN 13000.
3. In Abhängigkeit der Auslegerlänge sind bei den Traglasttabellen Windgeschwindigkeiten bis max. 13,3 m/s zulässig. Aufgrund unterschiedlicher Ausfahrfolgen der Teleskope können die in den Traglasttabellen angegebenen Auslegerlängen geringfügig abweichend sein.
4. Die Tragfähigkeiten sind in metrischen Tonnen angegeben.
5. Das Gewicht des Lasthakens bzw. der Unterflasche und weiterer Anschlagmittel ist von der Tragfähigkeit abzuziehen.
6. Die Tragfähigkeiten für den Teleskopausleger gelten nur bei demontierter Auslegerverlängerung.
7. Die Ausladung ist der horizontale Abstand von Mitte Drehkranz bis Mitte freihängender, nicht schwingender Last.

1. Les forces de levage sont conformes aux normes EN 13000.
2. Les forces de levage dans la partie de stabilité au renversement sont conformes aux normes ISO 4305 / EN 13000.
3. En fonction de la longueur de la flèche, des vitesses du vent jusqu'à 13,3 m/s maxi. sont admissibles avec les tableaux des charges. A cause des séquences d'extension différentes des télescopes individuels, les longueurs de flèche peuvent varier légèrement par rapport aux valeurs indiquées dans les tableaux de charge.
4. Les forces de levage sont données en tonnes métriques.
5. Le poids du crochet-moufle et de tous les accessoires d'élingage font partie de la charge et sont à déduire des charges indiquées.
6. Les forces de levage indiquées pour la flèche télescopique s'entendent rallonge de flèche déposée.
7. Comme portée, on entend la distance horizontale du centre de la couronne de rotation au centre de la charge librement suspendue et non oscillante.

### General remarks · Allgemeine Anmerkungen · Remarques générales

Unless otherwise specified, all the information given in this brochure refers to the standard equipment of the crane and only is intended as general information. For correct crane operation, the original operating manual and lifting capacity charts are essential. No liability is accepted for the accuracy of this information. Errors and omissions excepted. Illustrations are similar only. All dimensions - unless otherwise specified - in mm.

Alle Angaben in dieser Broschüre beziehen sich - wenn nicht anderweitig aufgeführt - auf die Standard-Ausstattung des Krans und dienen nur zur allgemeinen Information. Zum ordnungsgemäßen Betrieb des Krans sind die original Bedienungsanleitung und Traglasttabellen maßgeblich. Alle Angaben erfolgen ohne Gewähr. Änderungen und Irrtümer vorbehalten. Abbildungen ähnlich. Alle Bemaßungen - wenn nicht anders angegeben - in mm.

Sauf indication contraire, toutes les informations dans cette brochure se rapportent à l'équipement standard de la grue et constituent uniquement des informations générales. Pour le fonctionnement correct de la grue, le manuel d'instructions original et les tableaux des charges de levage sont déterminants. Toutes les informations sont fournies sans garantie. Sous réserve de modifications techniques et d'erreurs. Illustrations similaires mais pas identiques à l'engin montré. Toutes les cotes - sauf indication différente - en mm.

1. En cuanto a los datos referentes a resistencia, las capacidades de carga están basados sobre las normas EN 13000.
2. En cuanto a los datos referentes a estabilidad anti-vuelco, las capacidades de carga están basados sobre las normas ISO 4305 / EN 13000.
3. En función de la longitud de la pluma, las tablas de carga permiten velocidades del viento hasta un máximo de 13,3 m/s. Debido a las diferentes secuencias de extensión de los telescopios, puede haber algunas variaciones insignificantes con respecto a las longitudes de pluma indicadas en las tablas de carga.
4. Las capacidades de carga indicadas en las tablas corresponden a toneladas métricas.
5. Hay que deducir los pesos del gancho, eslingas y de otros dispositivos para fijación de cargas de los valores indicados en las tablas.
6. Las capacidades de carga referentes a la pluma telescópica valen solamente si el alargamiento de pluma está desmontado.
7. Como alcance se entiende la distancia horizontal desde el centro de la corona de giro hasta el centro de la carga suspendida libremente y no oscilante.

1. Le capacità di carico nel range di resistenza sono riferite alla norma EN 13000.
2. Le capacità di carico nel range di stabilità sono conformi alle norme ISO 4305 / EN 13000.
3. Nelle tabelle delle portate sono ammesse velocità del vento fino a max. 13,3 m/s in funzione della lunghezza del braccio. Considerata la diversa sequenza di sfilo dei telescopi, le lunghezze del braccio indicate nelle tabelle delle portate possono essere lievemente differenti.
4. Le capacità di carico sono indicate in tonnellate metriche.
5. Il peso del gancio di carico, ovvero del bozzello e delle altre imbracature deve essere detratto dalla capacità di carico.
6. Le capacità di carico per il braccio telescopico sono applicabili soltanto con prolunga del braccio smontata.
7. Per sbraccio si intende la distanza orizzontale dal centro della corona rotante al centro del carico sospeso, ma non oscillante.

1. Значения грузоподъемности в пределах категории прочности основаны на положениях стандарта EN 13000.
2. Значения грузоподъемности в пределах области устойчивости соответствуют стандарту ISO 4305 / EN 13000.
3. В зависимости от длины стрелы таблицы грузоподъемности допускают скорость ветра до макс. 13,3 м/с. При разных вариантах телескопирования стрелы её длина может незначительно отличаться от указанной в таблицах грузоподъемности.
4. Грузоподъемность указана в метрических тоннах.
5. Из грузоподъемности необходимо вычесть вес грузового крюка или крюковой обоймы, а также других грузозахватных приспособлений.
6. Значения грузоподъемности для телескопической стрелы действительны только при демонтированном удлинителе стрелы (гуське).
7. Вылет — это расстояние по горизонтали от центра поворотного круга до центра свободно подвешенного груза без раскачивания.













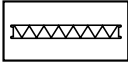
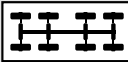









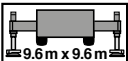





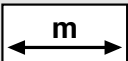

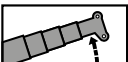
A no ser que se indique lo contrario, todos los datos incluidos en este folleto hacen referencia al equipamiento estándar de la grúa y sólo tienen un carácter informativo general. El manual de instrucciones original y las tablas de capacidades de carga son determinantes para lograr un correcto funcionamiento de la grúa. Todos los datos se facilitan sin garantía. Reservadas las modificaciones y los errores. Ilustraciones similares. Todas las dimensiones - salvo indicación en contrario - en mm.

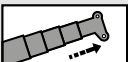
Se non diversamente specificato, tutti i dati di questa brochure si riferiscono alla dotazione standard della gru e sono da considerarsi come informazioni generali. Per un esercizio corretto della gru, sono determinanti il manuale d'uso originale e le tabelle delle portate. Si declina ogni responsabilità per tutti i dati. Con riserva di modifiche ed errori. Figure simili. Tutte le quotature sono in mm (se non diversamente specificato).

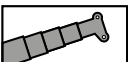
Все данные, приведенные в этой брошюре, относятся – если не указано иное – к стандартному оснащению крана и служат лишь для общей информации. Порядок надлежащей эксплуатации крана определяется оригиналом руководства по эксплуатации и таблицами грузоподъемности. Все данные приведены без обязательств. Возможны изменения и ошибки. Иллюстрации являются приблизительными. Все размеры – если не указано другое – в мм.

# Symbols · Symbolerklärung · Glossaire des symboles

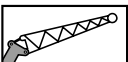
## Glosario de simbolos · Spiegazione dei simboli · Условные обозначения

	Gross weight · Gesamtgewicht Poids total · Peso total Peso totale · Полная масса		Luffing jib · Wippspitze Fléchette à volée variable · Plumín abatible Punta oscilante · маневровый гусек
	Axle load · Achslast Charge à l'essieu · Carga por eje Carico assiale · Осьевая нагрузка		Fly jib section · Spitzenteil Élément de fléchette · Plumín Parte punta · Головная секция
	Drive · Antrieb Entraînement · Tracción Trazione · Привод		Swing area · Drehbereich Rayon de rotation · Zona de giro Area di rotazione · Область поворота
	Tyres · Bereifung Pneus · Neumáticos Pneumatici · Шины		Hydraulically lockable · Hydraulisch verriegelbar Verrouillable hydrauliquement · Con embulonamiento hidráulico · Con dispositivo di bloccaggio idraulico Гидравлическая блокировка
	Gradeability · Steigfähigkeit · Capacité de gravissement de pente · Superación de pendientes · Capacità di salita Способность преодолевать подъем		Main winch · Hubwinde · Mécanisme de levage Cabrestante principal · Meccanismo di sollevamento Главная лебедка
	Off road / On road · Gelände / Straße Tout-terrain / Mode "Route" · Todo terreno / En carretera Fuori strada / Su strada · Бездорожье / Дорога		2 <sup>nd</sup> winch · 2. Winde 2 <sup>ème</sup> treuil · 2 <sup>o</sup> cabrestante Secondo argano · 2-я лебедка
	Speed · Geschwindigkeit Vitesse · Velocidad Velocità · Скорость		3 <sup>rd</sup> winch · 3. Winde 3 <sup>ème</sup> treuil · 3 <sup>o</sup> cabrestante Terzo argano · 3-я лебедка
	Outriggers · Abstützung Calage · Estabilizadores Stabilizzazione · На аутригерах		Type · Typ Tipo · Тип
	Counterweight · Gegengewicht Contrepoids · Contrapeso Contrappeso · Противовес		Lifting capacity · Traglast Charge de levage · Carga Portata · Грузоподъемность
	Counterweight element · Gegengewichtselement Élément de contrepoids · Parte del contrapeso Parte contrappeso · Деталь противовеса		Rope sheaves · Seilrollen Poulies de câbles · Poleas de cable Pulegge · Канатные шкивы
	Length · Länge Longueur · Longitud Lunghezza · Длина		Parts of line · Seilstränge Brins de câble · Ramales de cable Spire della fune · Запасовка
	Boom elevation · Wippwerk · Mécanisme de relevage Elevación de pluma · Gruppo di brandeggio Механизм изменения подъема стрелы		Dead-weight · Eigengewicht Poids total · Tara Peso proprio · Собственный вес
	Boom telescoping · Teleskopieren Télescopage de flèche · Telescopaje de pluma Telescopaggio · Телескопирование		Wire rope length · Hubseillänge Longueur du câble de levage · Longitud del cable de izaje · Lunghezza fune di sollevamento Длина подъемного троса
	Telescopic boom · Teleskopausleger Flèche télescopique · Pluma telescópica Braccio telescopico · Телескопическая стрела		Wire rope diameter · Hubseildurchmesser Diamètre du câble de levage · Diámetro del cable de elevación · Diametro fune di sollevamento Диаметр подъемного троса
	Radius · Ausladung Portée · Radio Sbraccio · Вылет		Wire rope pulling force · Hubseilzugkraft Force de traction du câble de levage · Fuerza de tracción del cable de elevación · Forza di trazione fune di sollevamento · Тяговое усилие подъемного троса
	Tiltable jib · abwinkelbare Spitze Fléchette inclinable · Plumín regulable Punta con regolazione angolo Гусек с изменением угла наклона		Weight · Gewicht Poids · Peso Peso · Bec
	Hydraulically tiltable jib · hydraulisch abwinkelbare Spitze Fléchette inclinable hydrauliquement · Plumín regulable hidráulicamente · Punta con regolazione angolo idraulica Гусек гидравлический с изменением угла наклона		

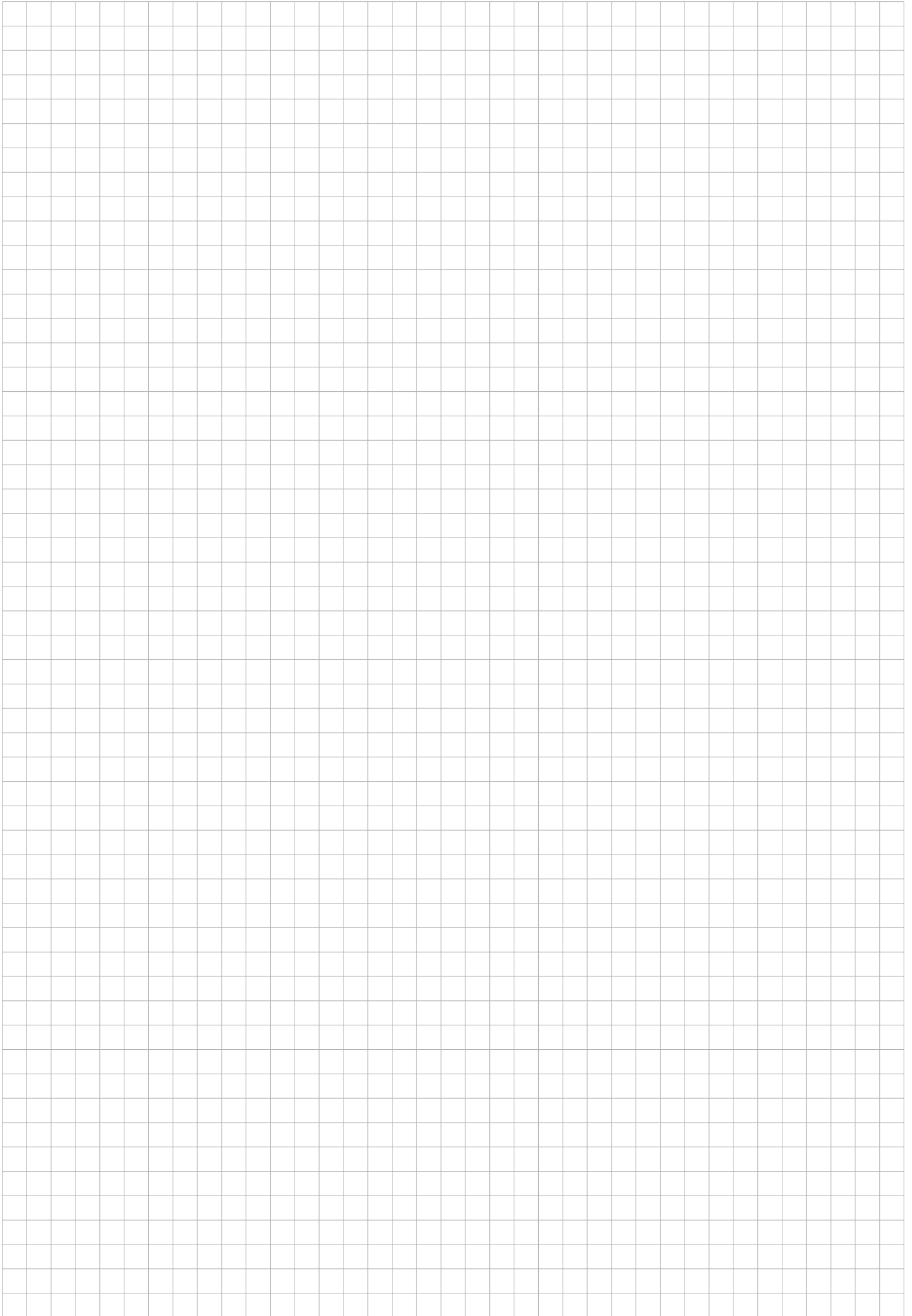



**TADANO FAUN GmbH**

Faunberg 2 · 91207 Lauf a. d. Pegnitz · Germany  
Phone: +49-9123-185-0 · Fax: +49-9123-3085  
[www.tadanofaun.de](http://www.tadanofaun.de) · [info@tadanofaun.de](mailto:info@tadanofaun.de)

**TADANO LTD.** (International Division)

4-12, Kamezawa 2-chome, Sumida-ku Tokyo 130-0014, Japan  
Phone: 81-3-3621-7750 · Fax: 81-3-3621-7785  
[www.tadano.com](http://www.tadano.com) · [info@tadano.com](mailto:info@tadano.com)