

# ATF 60G-3

60 TON MAX. LIFTING CAPACITY

EUROMOT 4

# ALL TERRAIN CRANE



# Table of contents · Inhaltsverzeichnis · Table des matières Índice · Sommario · Оглавление

## General · Allgemein · Généralités · Generalidades · Generalità · Общие положения

Boom systems · Auslegersysteme · Systèmes de flèche · Sistema de pluma · Sistemi di bracci · Конфигурации стрелы 4 - 5

Vehicle dimensions · Fahrzeugabmessungen · Dimensions du véhicule · Dimensiones del vehículo  
Dimensioni veicolo · Габариты машины 6

## On-road and off-road driving · Straßen- und Geländefahrt · Marche route et tout terrain Traslado por carretera y todoterreno · Marcia su strada e fuori strada · Движение по дорогам и бездорожью

Axle loads · Achslasten · Charges par essieu · Cargas por eje · Carichi assiali · Нагрузка на ось 8

Speeds and gradeability · Geschwindigkeiten und Steigfähigkeit · Vitesses de conduite et gravissement de pente  
Velocidades y pendientes superables · Velocità e pendenza · Скорость и грузоподъемность 8

Steering · Lenkung · Direction · Dirección · Sterzo · Рулевое управление 8

## Transport · Transporte · Trasporto · Транспортировка

Counterweight · Gegengewicht · Contrepoids · Contrapeso · Contrappeso · Противовес 10 - 11

Jibs · Spitzen · Fléchettes · Plumines · Punte · гусек 12

Auxiliary winch · Zusatzhubwinde · Treuil supplémentaire · Cabrestante auxiliar  
Argano aggiuntivo · Дополнительная лебедка 12

## Operation · Einsatz · Utilisation · Uso · Эксплуатация

Main boom · Hauptausleger · Flèche principale · Pluma principal · Braccio principale · Главная стрела 14

Swing mechanism · Drehwerk · Groupe de rotation · Mecanismo de giro · Gruppo di rotazione · Поворотный механизм 14

Winches · Hubwinden · Treuils · Cabrestantes · Argani · Лебедки 14

Hook blocks · Unterflaschen · Moufles · Pastecas de carga · Bozzelli · Крюковые обоймы 14

Working ranges and lifting capacities · Arbeitsbereiche und Traglasten · Rayons de travail et charges de levage  
Áreas de trabajo y cargas · Aree di lavoro e portate · Рабочие зоны и грузоподъемность 16 - 30

## Equipment · Ausstattung · Équipement · Equipamiento · Equipaggiamento · Оборудование

Equipment · Ausstattung · Équipement · Equipamiento · Equipaggiamento · Оборудование 32 - 38

## Additional information · Zusatzinformationen · Informations supplémentaires Información adicional · Altre informazioni · Дополнительная информация

Remarks · Anmerkungen · Remarques · Notas · Annotazioni · Примечания 40 - 41

Symbols · Symbolerklärung · Glossaire des symboles · Glosario de simbolos  
Spiegazione dei simboli · Условные обозначения 42

# GENERAL TECHNICAL DATA

ALLGEMEINE TECHNISCHE DATEN

CARACTÉRISTIQUES TECHNIQUES GÉNÉRALES

DATOS TÉCNICOS GENERALES

DATI TECNICI GENERALI

ОБЩИЕ ТЕХНИЧЕСКИЕ ХАРАКТЕРИСТИКИ



General · Allgemein · Généralités  
Generalidades · Generalità · Общие положения

Boom systems · Auslegersysteme · Systèmes de flèche  
Sistema de pluma · Sistemi di bracci · Конфигурации стрелы

m  
72  
70  
68  
66  
64  
62  
60  
58  
56  
54  
52  
50  
48  
46  
44  
42  
40  
38  
36  
34  
32  
30  
28  
26  
24  
22  
20  
18  
16  
14  
12  
10  
8  
6  
4  
2  
0

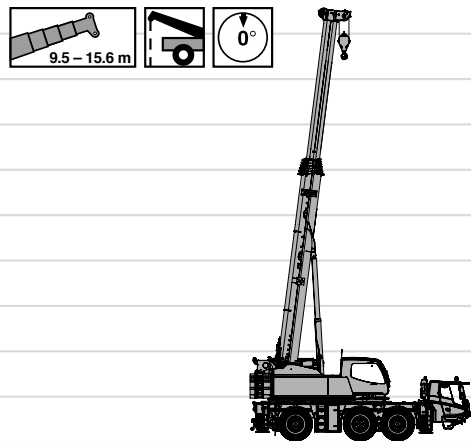
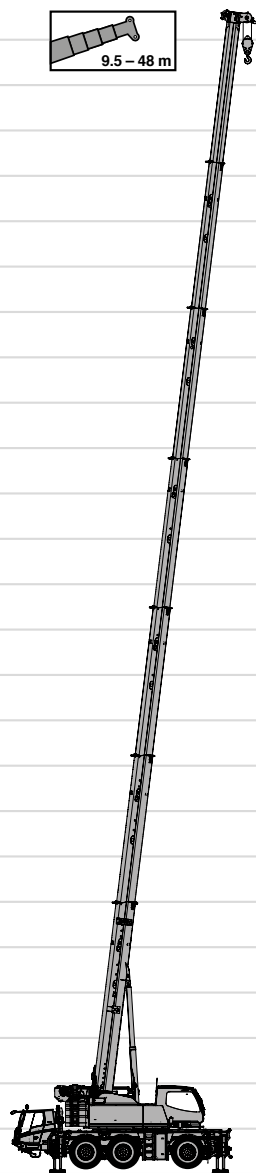

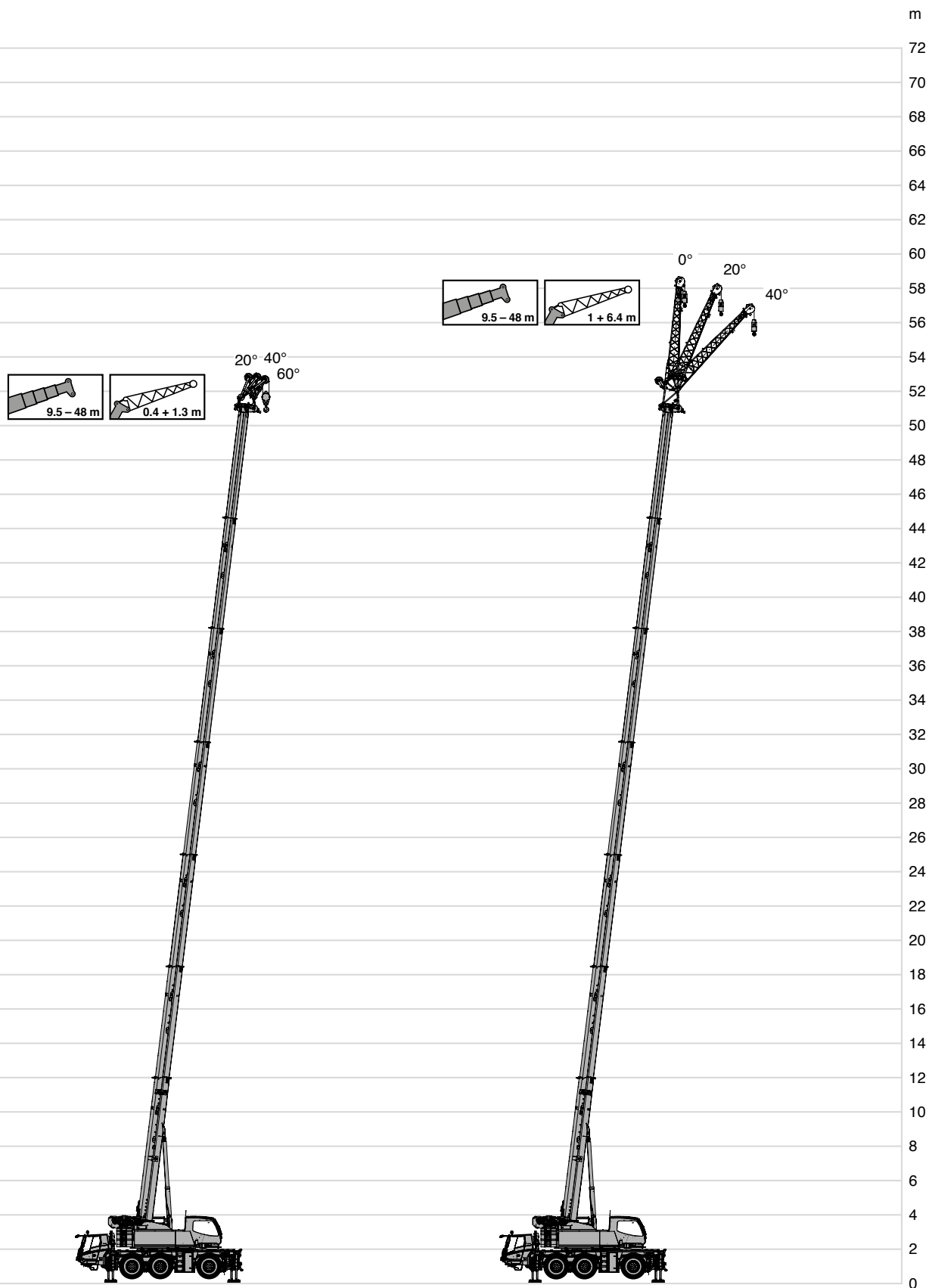

General · Allgemein · Généralités  
 Generalidades · Generalità · Общие положения

Vehicle dimensions · Fahrzeugabmessungen · Dimensions du véhicule  
 Dimensiones del vehículo · Dimensioni veicolo · Габариты машины

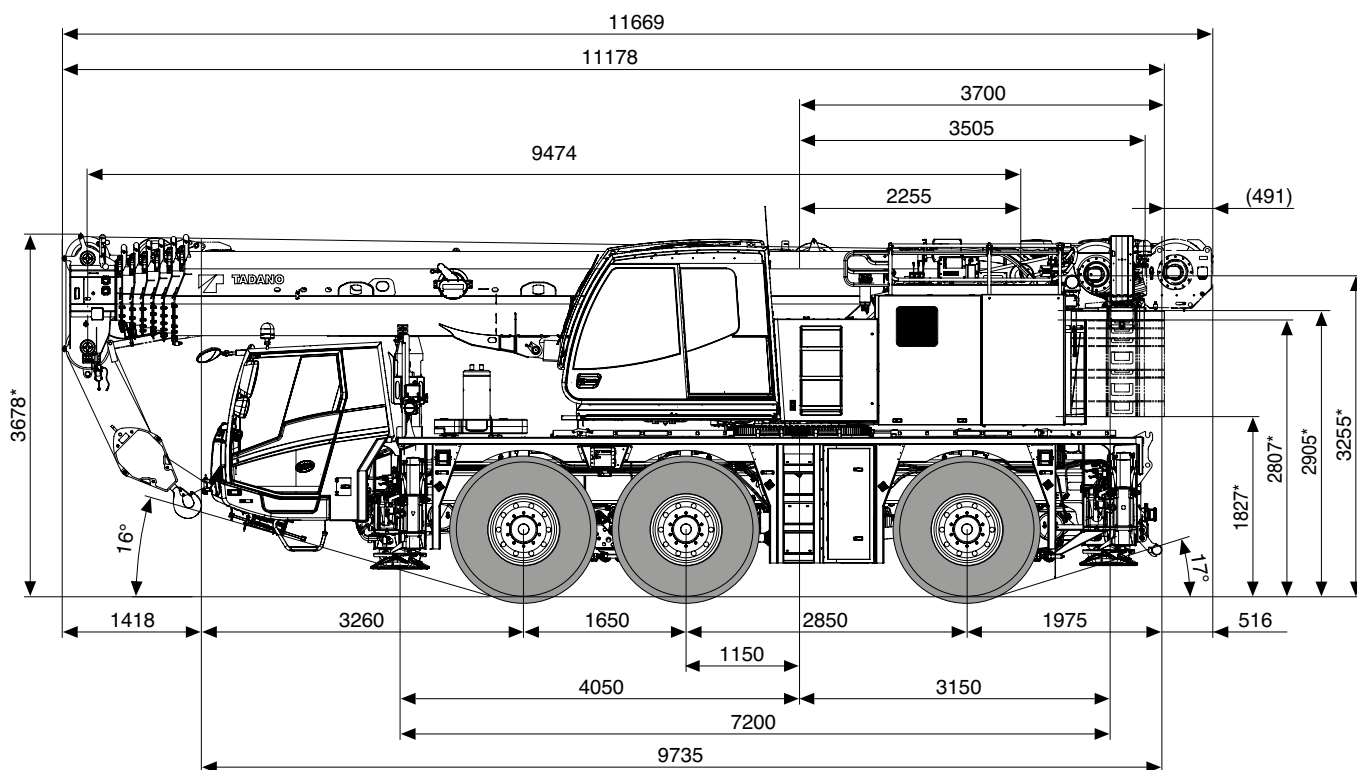

\* ± 100

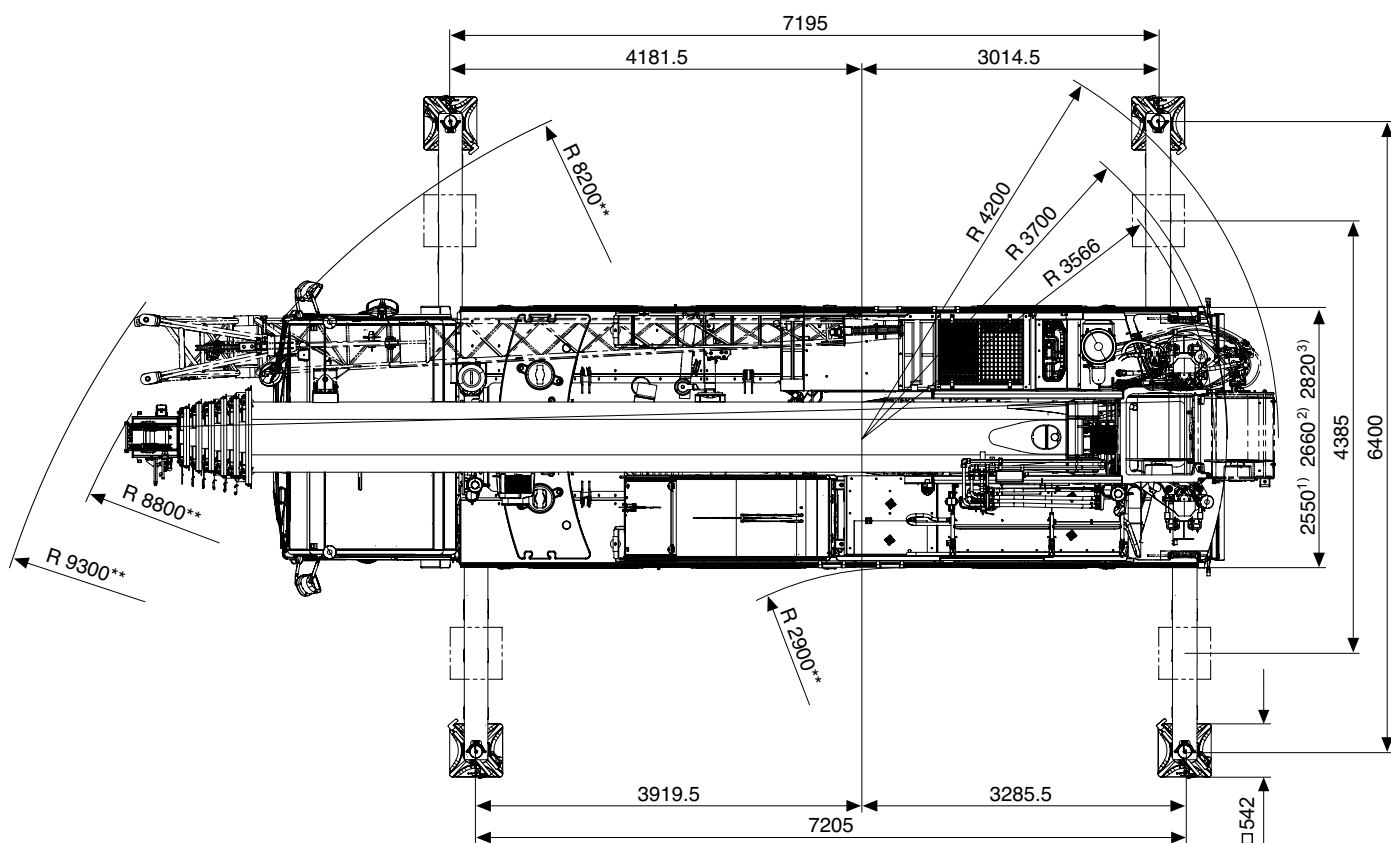

- 1) 385/95 R 25 (14.00 R 25)
- 2) 445/95 R 25 (16.00 R 25)
- 3) 525/80 R 25 (20.5 R 25)

\*\* Minimum · minimum · mínimo · minimo · мінімальны

# TECHNICAL DATA FOR ON-ROAD AND OFF-ROAD DRIVING

TECHNISCHE DATEN FÜR DIE STRASSEN- UND GELÄNDEFAHRT  
CARACTÉRISTIQUES TECHNIQUES POUR MARCHE ROUTE ET TOUT TERRAIN

DATOS TÉCNICOS PARA SU TRASLADO POR CARRETERA Y TODO TERRENO



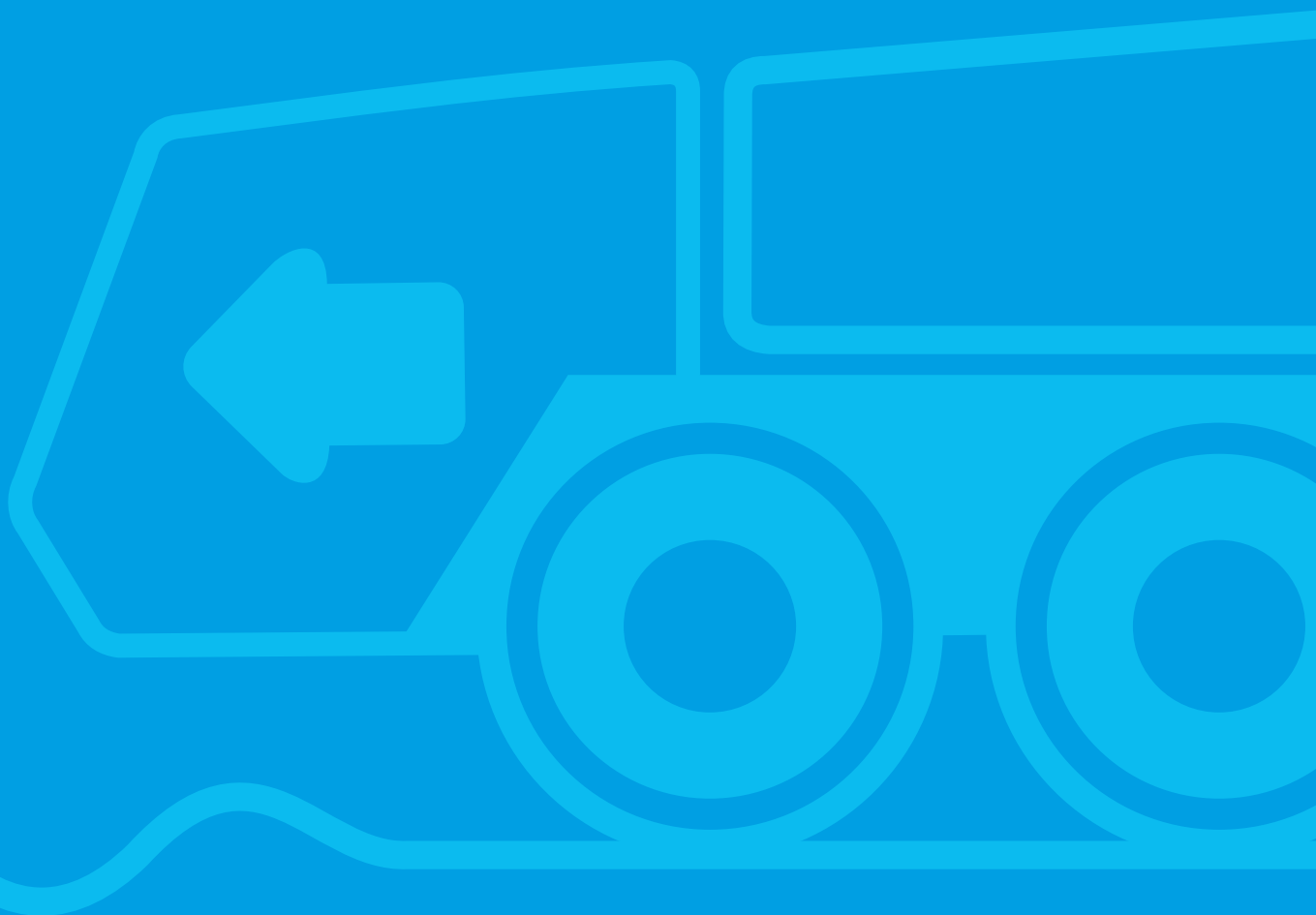

DATI TECNICI PER MARCIA SU STRADA E FUORI STRADA

ТЕХНИЧЕСКИЕ ХАРАКТЕРИСТИКИ ПРИ ДВИЖЕНИИ ПО ДОРОГАМ И БЕЗДОРОЖЬЮ



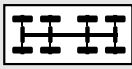

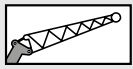



On-road and off-road driving · Straßen- und Geländefahrt · Marche route et tout terrain  
 Traslado por carretera y todoterreno · Marcia su strada e fuori strada  
 Движение по дорогам и бездорожью

Axle loads · Achslasten · Charges par essieu  
 Cargas por eje · Carichi assiali · Нагрузка на ось



	TOTAL			TYPE		
< 10 t	< 30 t	6 x 6	385/95 R 25	20	-	0 t
< 12 t	< 36 t ***	6 x 6	445/95 R 25	40 / 6	1 m + 6.4 m	4.2 t
< 12 t	< 36 t ***	6 x 6	445/95 R 25	40	-	5.1 t
< 13 t	< 39 t ***	6 x 6	445/95 R 25	40 / 6	1 m + 6.4 m	7.2 t
< 16.5 t	< 45 t ***	6 x 6	445/95 R 25	40 / 6	1 m + 6.4 m	13 t
max **	45 t ***	6 x 6	445/95 R 25	40 / 6	1 m + 6.4 m	13 t

\* Axle loads vary depending on equipment mounted. Individual calculation available on demand. · Achslasten variieren je nach Ausrüstungsumfang. Individuelle Berechnung auf Anfrage.  
 Las cargas por ejes pueden variar según el equipamiento. Cálculo individual sobre pedido. · Les charges par essieux peuvent varier en fonction de l'équipement monté. Calcul individuel sur demande.  
 I carichi degli assi variano in base all'entità dell'equipaggiamento. Calcolo individuale su richiesta. · Нагрузка на оси зависит от установленного оборудования. Индивидуальный расчет по запросу.  
 \*\* Construction site · Baustelle · Chantier de construction · Obra · Cantiere · стройплощадка  
 \*\*\* Incl. second winch or balancing weight · Inklusive zweite Winde oder Ausgleichsgewicht · Y compris deuxième treuil ou contrepoids d'équilibre  
 Incl. segundo cabrestante o peso de compensación · Incluso secondo argano o contrappeso · Включая вторую лебёдку или противовес

Speeds and gradeability · Geschwindigkeiten und Steigfähigkeit · Vitesses de conduite et gravisement de pente  
 Velocidades y pendientes superables · Velocità e pendenza · Скорость и грузоподъемность

	  / 	  / 
385/95 R 25	85 km/h max.	34 %
445/95 R 25 525/80 R 25	85 km/h max.	31 %

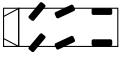
Steering · Lenkung · Direction  
 Dirección · Sterzo · Рулевое управление

	 v ≤ 85 km/h
	Manual steering · Manuelle Lenkung · Direction manuelle Dirección manual · Sterzo manuale · Ручное управление
	Diagonal steering · Hundegang · Marche en crabe Marcha cangrejo · Sterzata carrello · Движение по диагонали



# TECHNICAL DATA FOR TRANSPORT

TECHNISCHE DATEN FÜR DEN TRANSPORT  
CARACTÉRISTIQUES TECHNIQUES POUR LE TRANSPORT  
DATOS TÉCNICOS PARA EL TRANSPORTE  
DATI TECNICI PER IL TRASPORTO  
ТЕХНИЧЕСКИЕ ДАННЫЕ ДЛЯ ТРАНСПОРТИРОВКИ

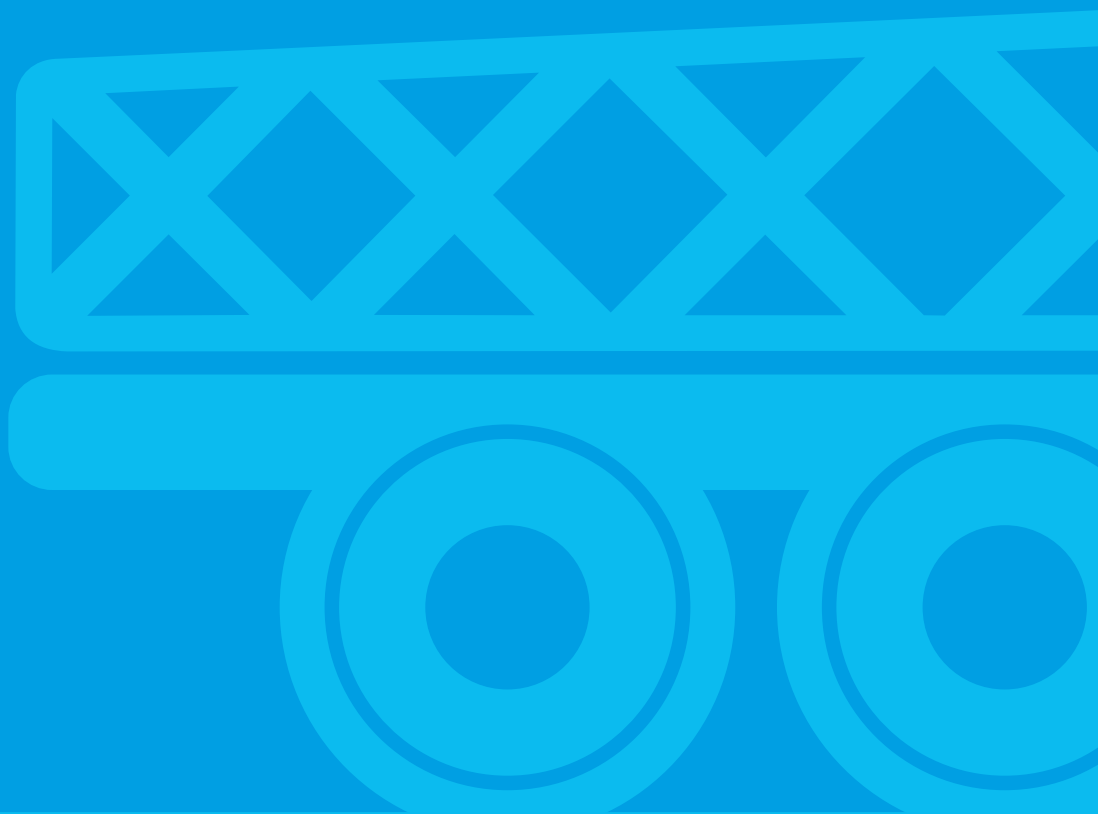

Transport · Transporte  
 Trasporto · Транспортировка

Counterweight · Gegengewicht · Contrepoids  
 Contrapeso · Contrappeso · Противовес

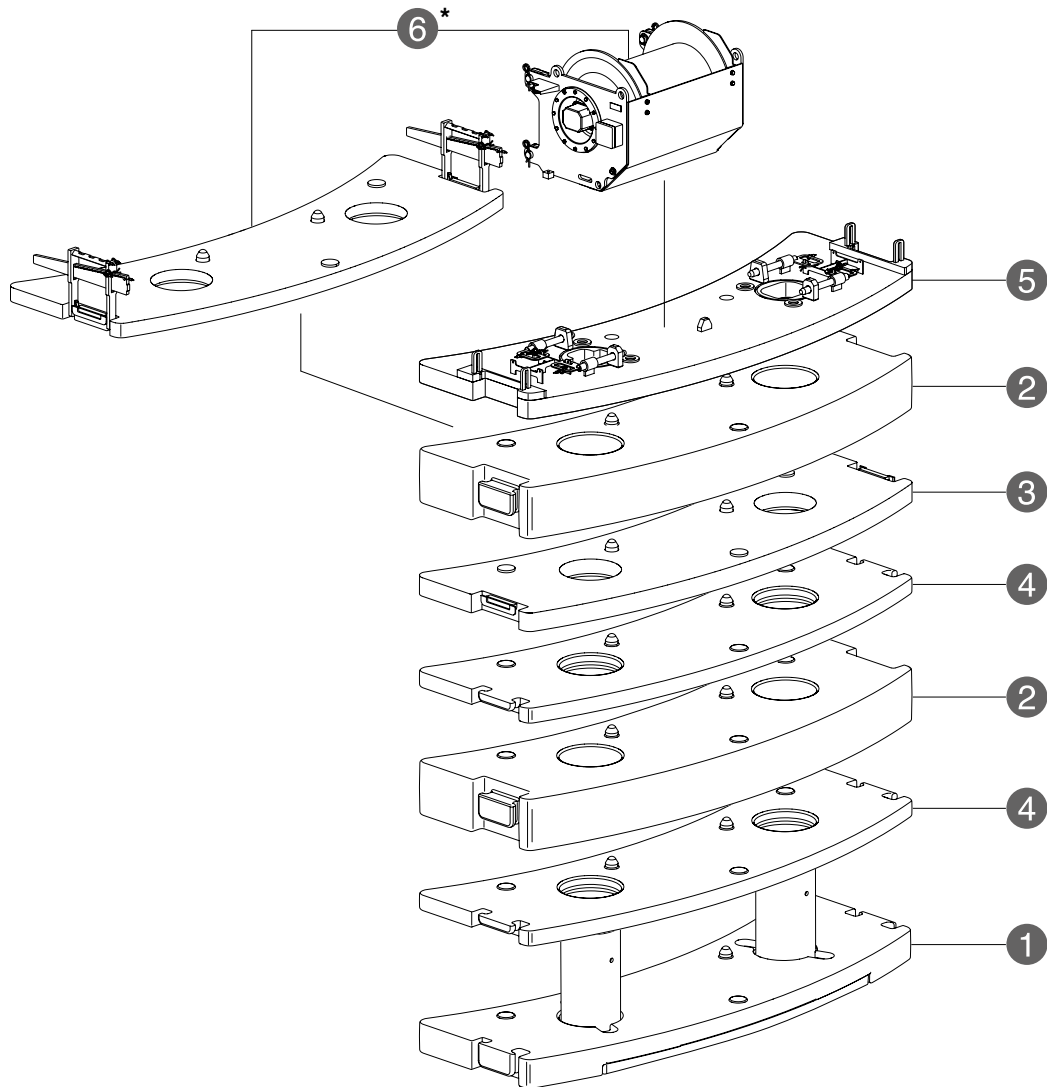

		2.1 t	3.3 t	4.2 t	5 t	5.1 t	7.2 t	8 t	9.2 t	10.1 t	13 t
①	2.1 t	-	-	1	-	1	1	1	1	1	1
②	2.9 t	-	-	-	1	-	-	1	1	1	2
③	1.2 t	-	1	-	-	-	1	-	1	1	1
④	0.9 t	-	-	-	-	1	2	1	1	2	2
⑤	1.2 t	1	1	1	1	1	1	1	1	1	1
⑥*	0.9 t	1	1	1	1	1	1	1	1	1	1

\* Can be replaced by 2<sup>nd</sup> winch · Ersetzbar durch 2. Winde · Peut être remplacé par un 2<sup>e</sup> treuil · Sostituibile por 2<sup>o</sup> cabrestante · Sostituibile con 2<sup>o</sup> argano · Возможность замены на 2-ю лебедку

1

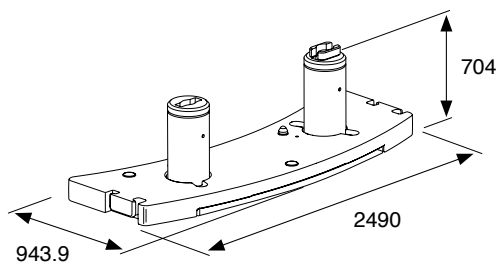

2

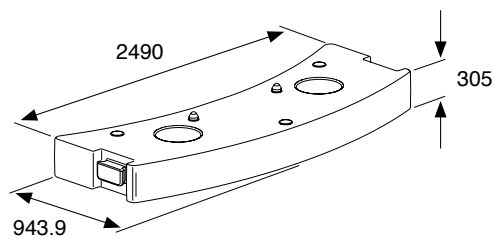

3

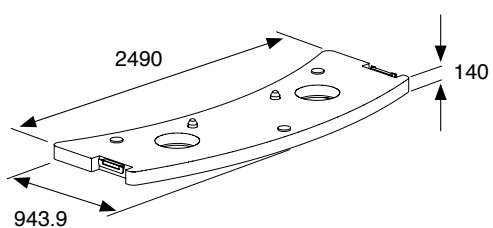

4

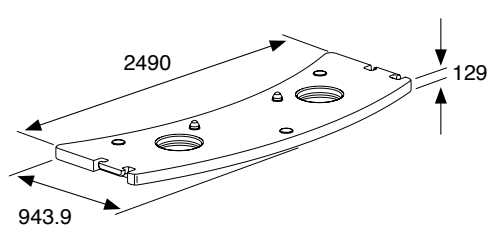

5

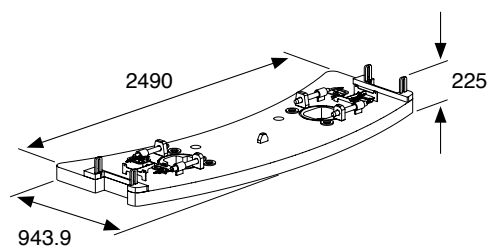

6\*

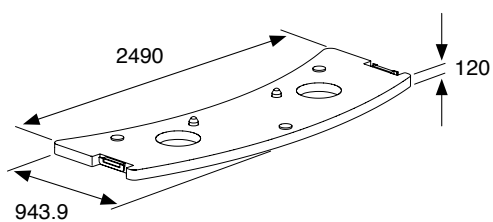

\* Can be replaced by 2<sup>nd</sup> winch · Ersetzbar durch 2. Winde · Peut être remplacé par un 2<sup>e</sup> treuil · Sustituable por 2<sup>o</sup> cabrestante · Sostituibile con 2<sup>o</sup> argano · Возможность замены на 2-ю лебедку

Transport · Transporte  
 Trasporto · Транспортировка

Jibs · Spitzen · Fléchettes  
 Plumines · Punte · гусек

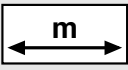
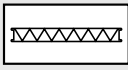
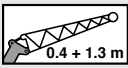
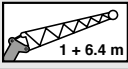
		
	0.4 m + 1.3 m	①
	1 m + 6.4 m	②

①  330

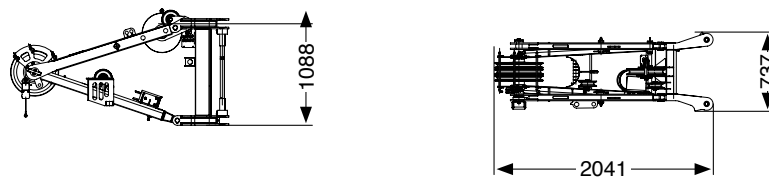

②  575

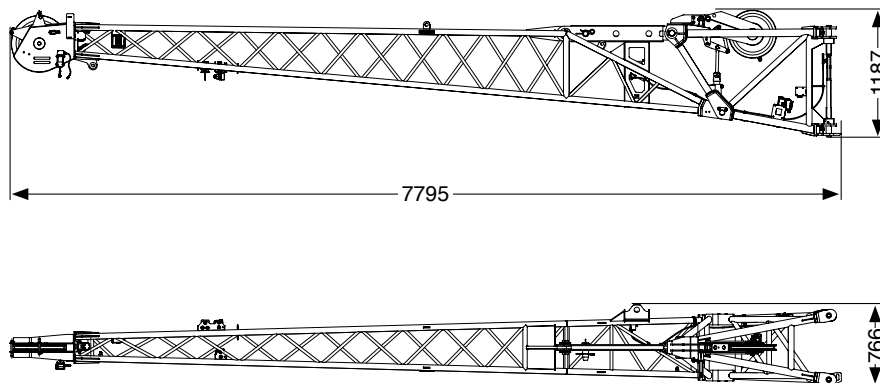

Auxiliary winch · Zusatzhubwinde · Treuil supplémentaire  
 Cabrestante auxiliar · Argano aggiuntivo · Дополнительная лебедка

 663/  
1031\*

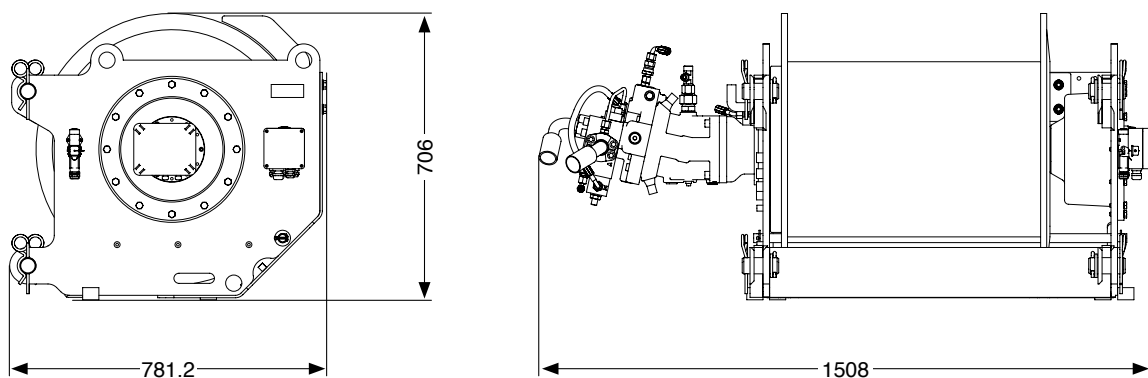

\* with rope · mit Seil · avec câble · con cable · con fune · с тросом

# TECHNICAL DATA FOR OPERATION

TECHNISCHE DATEN FÜR DEN EINSATZ

CARACTÉRISTIQUES TECHNIQUES POUR L'UTILISATION

DATOS TÉCNICOS PARA EL USO

DATI TECNICI PER L'USO

ТЕХНИЧЕСКИЕ ЭКСПЛУАТАЦИОННЫЕ ХАРАКТЕРИСТИКИ



Operation · Einsatz · Utilisation  
 Uso · Эксплуатация

Main boom · Hauptausleger · Flèche principale  
 Pluma principal · Braccio principale · Главная стрела

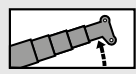

- 5° – 82.7°

~ 30 s

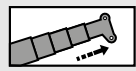

9.5 m – 48 m

~ 490 s

Swing mechanism · Drehwerk · Groupe de rotation  
 Mecanismo de giro · Gruppo di rotazione · Поворотный механизм



0 – 2.3 min<sup>-1</sup>



0° – 360°

Winches · Hubwinden · Treuils  
 Cabrestantes · Argani · Лебедка



0 – 100 m/min

18 mm / 230 m

57



0 – 100 m/min

18 mm / 230 m

57

Hook blocks · Unterflaschen · Moufles  
 Pastecas de carga · Bozzelli · Крюковые обоймы



63\*

60

5

11

650

40\*

39.6

3

7

550

40

39.6

3

7

550

20

17.1

1

3

300

6

5.7

-

1

175

\* Twin hook · Doppelhaken · Moufle avec crochet marin · Gancho doble · Gancio doppio · Двойной крюк

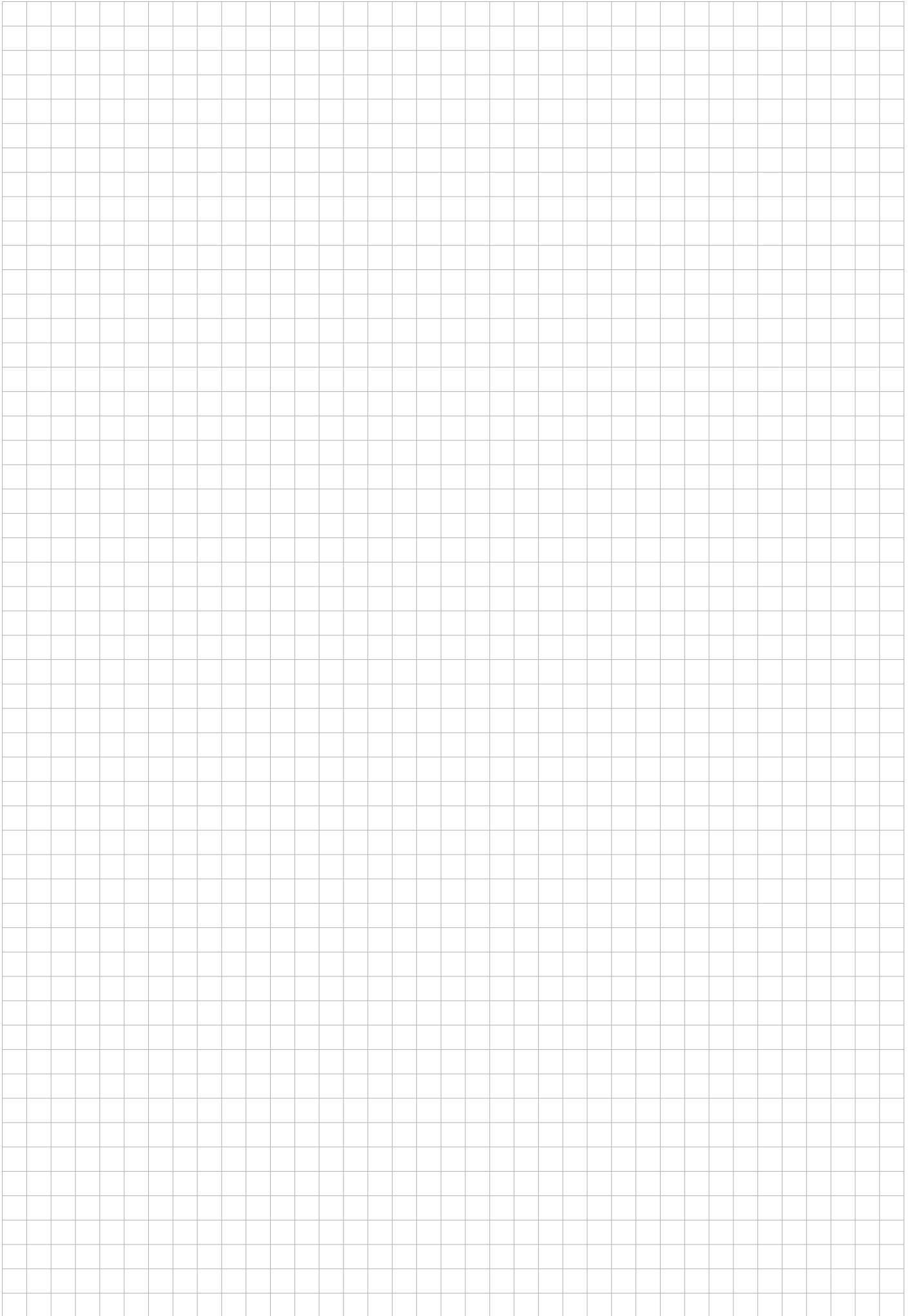

Operation · Einsatz · Utilisation  
 Uso · Эксплуатация

Working range · Arbeitsbereich · Rayon de travail  
 Zona de trabajo · Area di lavoro · Рабочая зона

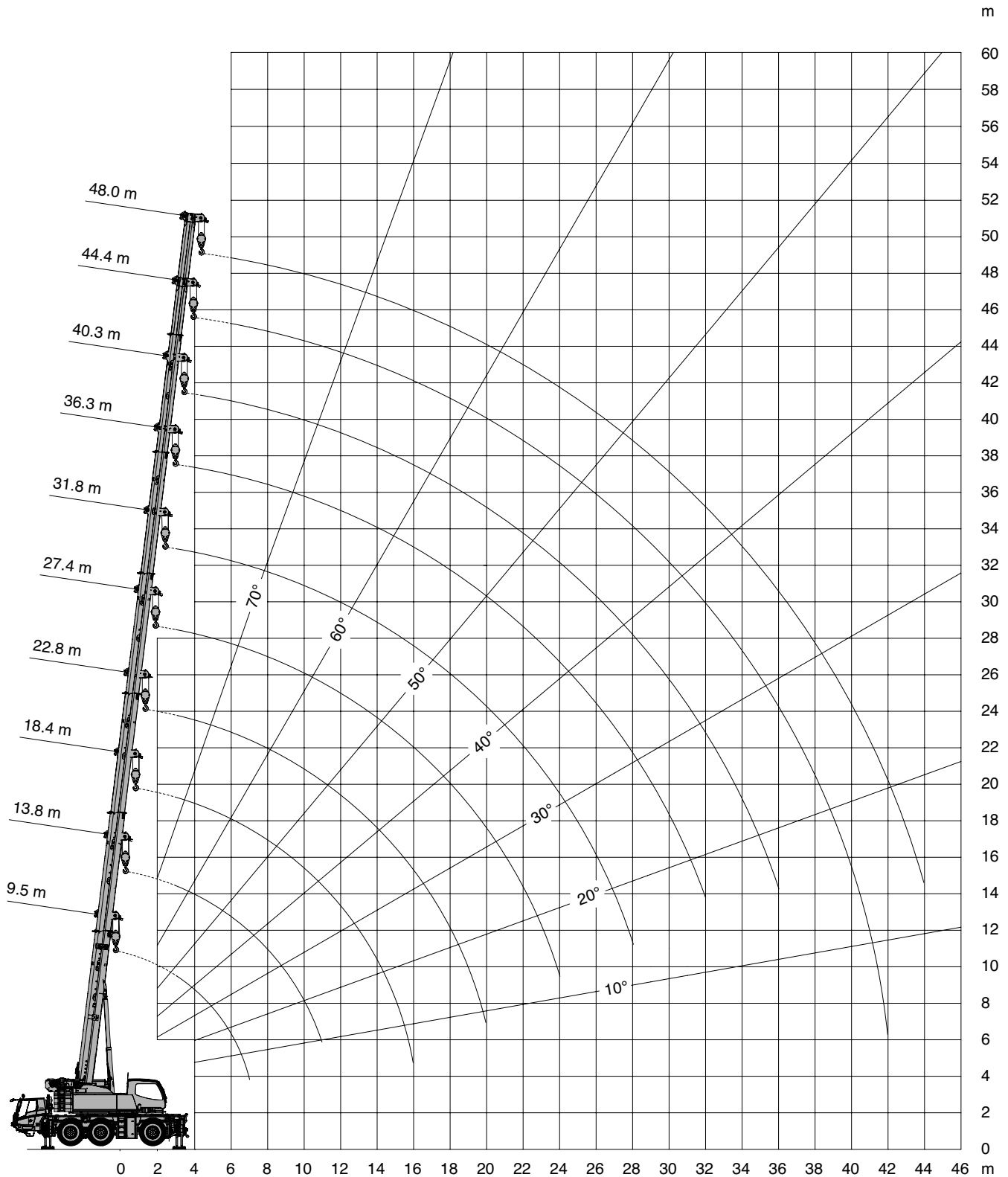



Lifting capacities · Traglasten · Charges de levage  
 Cargas · Portate · Грузоподъемность

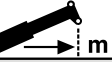

 m	9.5 m*	9.5 m	13.8 m	18.4 m	22.8 m	27.4 m	31.8 m	36.3 m	40.3 m	44.4 m	48.0 m
2.5	60.0**	49.0**	45.1**	45.1**	34.3	23.2	15.2				
3.0	50.5**	43.3	43.3	42.0	34.3	23.2	15.2				
3.5	43.2	38.7	38.7	38.0	34.3	23.2	15.2	13.6			
4.0	38.1	34.8	34.8	34.1	32.2	23.2	15.2	13.6			
4.5	35.2	31.6	31.6	30.9	30.2	23.2	15.2	13.6	9.4		
5.0	32.7	28.8	29.1	28.1	28.0	23.2	15.2	13.6	9.4		
6.0	28.0	24.3	24.6	23.7	23.9	21.1	15.2	13.6	9.4	7.7	6.3
7.0	20.4	20.4	21.2	20.7	20.4	19.3	15.2	13.6	9.4	7.7	6.3
8.0			18.5	18.0	17.7	17.7	14.5	13.4	9.4	7.7	6.3
9.0			16.5	16.1	15.5	15.9	13.5	12.5	9.4	7.7	6.3
10.0			14.6	14.4	13.8	14.0	12.6	11.7	9.4	7.7	6.3
11.0			13.0	12.8	12.7	12.4	11.8	10.9	9.4	7.7	6.3
12.0				11.5	11.4	11.0	11.1	10.3	8.9	7.7	6.3
14.0				9.0	9.4	9.1	8.9	8.5	8.0	7.0	6.3
16.0				7.8	7.7	7.4	7.3	6.7	7.3	6.4	5.8
18.0					6.3	6.7	6.5	5.8	5.9	5.8	5.3
20.0					5.5	5.7	5.5	5.2	4.9	5.0	4.9
22.0						4.9	4.8	4.7	4.5	4.4	4.3
24.0						4.2	4.2	4.1	4.1	3.7	3.7
26.0							3.6	3.7	3.6	3.1	3.1
28.0							3.2	3.3	3.1	2.7	2.6
30.0								2.9	2.7	2.3	2.2
32.0								2.6	2.4	1.9	1.9
34.0									2.1	1.7	1.6
36.0									1.9	1.4	1.4
38.0										1.2	1.1
40.0										1.0	0.9
42.0										0.6	0.7
44.0											0.6



 m	9.5 m*	9.5 m	13.8 m	18.4 m	22.8 m	27.4 m	31.8 m	36.3 m	40.3 m	44.4 m	48.0 m
2.5	49.7**	48.0**	45.1**	45.1**	34.3	23.2	15.2				
3.0	45.1**	42.4	42.4	41.7	34.3	23.2	15.2				
3.5	41.2	37.8	37.8	37.1	34.3	23.2	15.2	13.6			
4.0	37.9	33.9	33.9	33.2	32.2	23.2	15.2	13.6			
4.5	33.7	30.7	31.0	30.0	29.9	23.2	15.2	13.6	9.4		
5.0	30.0	28.0	28.3	27.2	27.5	23.2	15.2	13.6	9.4		
6.0	24.4	23.5	23.9	23.4	23.1	21.1	15.2	13.6	9.4	7.7	6.3
7.0	20.4	20.2	20.5	20.0	19.7	19.3	15.2	13.6	9.4	7.7	6.3
8.0			17.9	17.6	17.0	17.4	14.5	13.4	9.4	7.7	6.3
9.0			15.7	15.5	15.0	15.1	13.5	12.5	9.4	7.7	6.3
10.0			13.9	13.6	13.4	13.0	12.6	11.7	9.4	7.7	6.3
11.0			11.9	11.6	11.5	11.1	11.5	10.9	9.4	7.7	6.3
12.0				10.1	10.6	10.4	10.0	9.6	8.9	7.7	6.3
14.0				8.4	8.3	8.3	8.2	7.3	7.9	7.0	6.3
16.0				7.1	6.7	7.1	6.8	6.4	6.3	6.3	5.8
18.0					6.0	5.9	5.8	5.7	5.4	5.3	5.3
20.0					5.1	4.9	4.9	4.8	4.9	4.4	4.4
22.0						4.4	4.2	4.3	4.1	3.7	3.6
24.0						3.8	3.6	3.7	3.5	3.1	3.0
26.0							3.1	3.2	3.0	2.6	2.5
28.0							2.6	2.8	2.6	2.2	2.1
30.0								2.4	2.3	1.8	1.8
32.0								2.1	1.9	1.5	1.5
34.0									1.7	1.2	1.2
36.0									1.5	1.0	1.0
38.0										0.8	0.7
40.0										0.6	0.5

\* Over rear · Nach hinten · A l'arrière · Hacia atrás · Indietro · Назад

\*\* With additional lifting equipment · Mit Zusatzhubausrüstung · Avec équipement de levage supplémentaire

Con equipamiento de elevación adicional · Con attrezzaggio di sollevamento supplementare · С дополнительным подъемным оборудованием

Operation · Einsatz · Utilisation  
 Uso · Эксплуатация



 m	9.5 m*	9.5 m	13.8 m	18.4 m	22.8 m	27.4 m	31.8 m	36.3 m	40.3 m	44.4 m	48.0 m
2.5	49.7**	47.7**	45.1**	45.1**	34.3	23.2	15.2				
3.0	45.0**	42.1	42.1	41.4	34.3	23.2	15.2				
3.5	41.2	37.5	37.5	36.8	34.3	23.2	15.2	13.6			
4.0	37.8	33.6	33.7	32.9	32.2	23.2	15.2	13.6			
4.5	33.2	30.4	30.7	29.7	29.6	23.2	15.2	13.6	9.4		
5.0	29.5	27.7	28.0	27.0	27.3	23.2	15.2	13.6	9.4		
6.0	24.0	23.3	23.6	23.2	22.8	21.1	15.2	13.6	9.4	7.7	6.3
7.0	20.1	19.9	20.2	19.8	19.5	19.3	15.2	13.6	9.4	7.7	6.3
8.0			17.7	17.5	16.7	17.1	14.5	13.4	9.4	7.7	6.3
9.0			15.4	15.2	15.0	14.8	13.5	12.5	9.4	7.7	6.3
10.0			13.3	13.0	12.9	12.5	12.6	11.7	9.4	7.7	6.3
11.0			11.4	11.2	11.5	11.1	11.1	10.5	9.4	7.7	6.3
12.0				10.1	10.2	9.9	9.6	9.1	8.9	7.7	6.3
14.0				8.0	7.9	8.3	8.1	7.2	7.5	7.0	6.3
16.0				6.8	6.7	6.8	6.5	6.4	6.0	6.0	5.8
18.0					5.7	5.6	5.6	5.4	5.4	5.1	5.0
20.0					4.8	4.7	4.7	4.8	4.7	4.2	4.1
22.0						4.2	3.9	4.1	3.9	3.5	3.4
24.0							3.6	3.4	3.5	3.3	2.9
26.0								2.9	3.0	2.9	2.4
28.0								2.5	2.6	2.4	2.0
30.0									2.3	2.1	1.6
32.0									2.0	1.8	1.3
34.0										1.5	1.1
36.0										1.3	0.9
38.0											0.7
40.0											0.5



 m	9.5 m*	9.5 m	13.8 m	18.4 m	22.8 m	27.4 m	31.8 m	36.3 m	40.3 m	44.4 m	48.0 m
2.5	49.6**	47.3**	45.1**	45.1**	34.3	23.2	15.2				
3.0	45.0**	41.7	41.7	41.0	34.3	23.2	15.2				
3.5	41.1	37.1	37.1	36.4	34.3	23.2	15.2	13.6			
4.0	37.0	33.3	33.3	32.6	32.2	23.2	15.2	13.6			
4.5	32.5	30.1	30.4	29.4	29.6	23.2	15.2	13.6	9.4		
5.0	28.9	27.3	27.7	26.6	26.9	23.2	15.2	13.6	9.4		
6.0	23.5	23.0	23.3	22.8	22.5	21.1	15.2	13.6	9.4	7.7	6.3
7.0	19.7	19.6	20.0	19.5	19.2	19.3	15.2	13.6	9.4	7.7	6.3
8.0			17.4	17.2	16.4	16.7	14.5	13.4	9.4	7.7	6.3
9.0			15.0	14.7	14.5	14.1	13.5	12.5	9.4	7.7	6.3
10.0			12.6	12.3	12.5	11.9	12.2	11.2	9.4	7.7	6.3
11.0			11.1	10.9	11.0	10.8	10.4	9.8	9.4	7.7	6.3
12.0				9.7	9.6	9.4	9.2	8.6	8.9	7.7	6.3
14.0				7.8	7.5	7.9	7.7	7.2	7.1	7.0	6.3
16.0				6.5	6.5	6.4	6.4	6.2	6.0	5.9	5.8
18.0					5.4	5.3	5.2	5.3	5.2	4.7	4.7
20.0					4.5	4.6	4.4	4.5	4.4	3.9	3.8
22.0						3.9	3.7	3.8	3.7	3.2	3.1
24.0							3.3	3.1	3.3	2.6	2.6
26.0								2.7	2.8	2.2	2.1
28.0								2.3	2.4	2.2	1.8
30.0									2.1	1.9	1.4
32.0									1.8	1.6	1.1
34.0										1.4	0.9
36.0										1.2	0.7
38.0											0.5

\* Over rear · Nach hinten · A l'arrière · Hacia atrás · Indietro · Назад

\*\* With additional lifting equipment · Mit Zusatzhubausrüstung · Avec équipement de levage supplémentaire

Con equipamiento de elevación adicional · Con attrezzaggio di sollevamento supplementare · С дополнительным подъемным оборудованием



 m	9.5 m*	9.5 m	13.8 m	18.4 m	22.8 m	27.4 m	31.8 m	36.3 m	40.3 m	44.4 m	48.0 m
2.5	49.5**	46.9**	45.1**	45.1**	34.3	23.2	15.2				
3.0	44.9	41.3	41.4	40.7	34.3	23.2	15.2				
3.5	41.0	36.8	36.8	36.1	34.3	23.2	15.2	13.6			
4.0	36.5	33.0	33.1	32.3	32.2	23.2	15.2	13.6			
4.5	32.0	29.8	30.1	29.1	29.4	23.2	15.2	13.6	9.4		
5.0	28.5	27.1	27.4	26.6	26.6	23.2	15.2	13.6	9.4		
6.0	23.1	22.7	23.1	22.6	22.3	21.1	15.2	13.6	9.4	7.7	6.3
7.0	19.4	19.4	19.7	19.4	18.9	19.2	15.2	13.6	9.4	7.7	6.3
8.0			17.1	16.9	16.4	16.2	14.5	13.4	9.4	7.7	6.3
9.0			14.4	14.1	13.9	13.5	13.5	12.4	9.4	7.7	6.3
10.0			12.1	11.8	12.3	11.9	11.6	10.6	9.4	7.7	6.3
11.0			10.6	10.6	10.6	10.3	10.0	9.2	9.4	7.7	6.3
12.0				9.2	9.2	9.4	9.2	8.1	8.5	7.7	6.3
14.0				7.6	7.5	7.6	7.3	7.2	6.7	6.7	6.3
16.0				6.2	6.2	6.1	6.1	5.9	6.0	5.6	5.4
18.0					5.3	5.2	5.0	5.1	5.0	4.5	4.4
20.0					4.3	4.3	4.1	4.3	4.1	3.6	3.6
22.0						3.7	3.5	3.6	3.5	3.0	2.9
24.0							3.2	2.9	3.1	2.9	2.4
26.0								2.5	2.6	2.5	2.0
28.0								2.1	2.3	2.1	1.6
30.0									1.9	1.8	1.3
32.0									1.7	1.5	1.0
34.0										1.3	0.8
36.0										1.0	0.5



 m	9.5 m*	9.5 m	13.8 m	18.4 m	22.8 m	27.4 m	31.8 m	36.3 m	40.3 m	44.4 m	48.0 m
2.5	49.3**	46.1**	45.1**	45.1**	34.3	23.2	15.2				
3.0	44.7	40.6	40.6	39.9	34.3	23.2	15.2				
3.5	40.6	36.0	36.1	35.3	34.3	23.2	15.2	13.6			
4.0	35.1	32.3	32.6	31.6	31.5	23.2	15.2	13.6			
4.5	30.8	29.1	29.4	28.4	28.7	23.2	15.2	13.6	9.4		
5.0	27.3	26.4	26.7	26.3	26.0	23.2	15.2	13.6	9.4		
6.0	22.2	22.1	22.4	22.0	21.7	21.1	15.2	13.6	9.4	7.7	6.3
7.0	18.6	18.6	19.1	18.9	18.0	17.3	15.2	13.6	9.4	7.7	6.3
8.0			15.8	15.5	15.3	14.2	14.0	12.8	9.4	7.7	6.3
9.0			12.9	12.7	13.2	12.9	11.8	10.8	9.4	7.7	6.3
10.0			11.0	11.1	11.0	10.8	10.6	9.2	9.4	7.7	6.3
11.0			9.4	9.5	9.4	9.9	9.6	8.6	8.3	7.7	6.3
12.0				8.6	8.5	8.6	8.4	8.1	7.5	7.3	6.3
14.0				6.7	6.8	6.7	6.7	6.6	6.7	5.9	5.7
16.0				5.4	5.6	5.5	5.3	5.5	5.3	4.8	4.6
18.0					4.6	4.5	4.3	4.5	4.3	3.8	3.7
20.0					3.8	3.8	3.6	3.7	3.6	3.1	3.0
22.0						3.2	3.0	3.1	3.0	2.5	2.4
24.0							2.7	2.5	2.6	2.5	2.0
26.0								2.1	2.2	2.0	1.5
28.0								1.7	1.9	1.7	1.2
30.0									1.6	1.4	0.9
32.0									1.3	1.2	0.7
34.0										0.9	
36.0										0.7	

\* Over rear · Nach hinten · A l'arrière · Hacia atrás · Indietro · Назад

\*\* With additional lifting equipment · Mit Zusatzhubausrüstung · Avec équipement de levage supplémentaire

Con equipamiento de elevación adicional · Con attrezzaggio di sollevamento supplementare · С дополнительным подъемным оборудованием

Operation · Einsatz · Utilisation  
 Uso · Эксплуатация



 m	9.5 m*	9.5 m	13.8 m	18.4 m	22.8 m	27.4 m	31.8 m	36.3 m	40.3 m	44.4 m	48.0 m
2.5	49.3**	45.8**	45.1**	45.1**	34.3	23.2	15.2				
3.0	44.7	40.3	40.3	39.6	34.3	23.2	15.2				
3.5	40.0	35.7	35.8	35.0	34.3	23.2	15.2	13.6			
4.0	34.5	32.0	32.3	31.3	31.5	23.2	15.2	13.6			
4.5	30.3	28.8	29.2	28.4	28.4	23.2	15.2	13.6	9.4		
5.0	26.9	26.1	26.5	26.0	25.7	23.2	15.2	13.6	9.4		
6.0	21.8	21.8	22.2	21.7	21.4	20.5	15.2	13.6	9.4	7.7	6.3
7.0	18.1	18.1	18.8	18.6	18.0	16.4	15.2	13.6	9.4	7.7	6.3
8.0			15.1	14.8	14.8	14.0	13.2	12.1	9.4	7.7	6.3
9.0			12.6	12.6	12.6	12.3	11.4	10.2	9.4	7.7	6.3
10.0			10.5	10.6	10.5	10.8	10.6	9.2	9.0	7.7	6.3
11.0			9.0	9.4	9.1	9.5	9.2	8.6	7.8	7.6	6.3
12.0				8.2	8.3	8.2	8.1	8.0	7.5	7.0	6.3
14.0				6.4	6.6	6.5	6.4	6.5	6.4	5.5	5.3
16.0				5.1	5.3	5.3	5.1	5.2	5.1	4.4	4.3
18.0					4.4	4.3	4.1	4.3	4.1	3.6	3.4
20.0					3.5	3.6	3.4	3.5	3.3	2.9	2.8
22.0						3.0	2.8	2.9	2.8	2.3	2.2
24.0							2.5	2.3	2.3	1.8	1.8
26.0								1.9	2.0	1.4	1.4
28.0								1.6	1.7	1.5	1.0
30.0									1.4	1.3	0.8
32.0									1.2	1.0	
34.0										0.8	
36.0										0.6	



 m	9.5 m*	9.5 m	13.8 m	18.4 m	22.8 m	27.4 m	31.8 m	36.3 m	40.3 m	44.4 m	48.0 m
2.5	49.2**	45.4**	45.1**	44.8	34.3	23.2	15.2				
3.0	44.6	39.9	39.9	39.2	34.3	23.2	15.2				
3.5	39.3	35.4	35.6	34.7	34.3	23.2	15.2	13.6			
4.0	33.9	31.6	32.0	30.9	31.2	23.2	15.2	13.6			
4.5	29.7	28.5	28.8	28.4	28.1	23.2	15.2	13.6	9.4		
5.0	26.4	25.8	26.2	25.7	25.4	23.2	15.2	13.6	9.4		
6.0	21.4	21.4	21.8	21.5	20.2	19.3	15.2	13.6	9.4	7.7	6.3
7.0	17.1	17.1	18.1	17.7	17.2	15.4	15.0	13.6	9.4	7.7	6.3
8.0			14.2	13.9	14.6	13.8	12.4	11.3	9.4	7.7	6.3
9.0			11.9	12.0	11.9	11.6	11.4	9.9	9.4	7.7	6.3
10.0			9.9	10.1	9.9	10.5	10.0	9.2	8.4	7.7	6.3
11.0			8.5	9.0	9.1	9.0	8.7	8.5	7.8	7.3	6.3
12.0				7.8	7.9	7.8	7.8	7.5	7.4	6.5	6.2
14.0				6.0	6.3	6.2	6.0	6.2	6.0	5.1	4.9
16.0				4.8	5.0	4.9	4.7	4.9	4.7	4.1	3.9
18.0					4.1	4.0	3.8	4.0	3.8	3.3	3.1
20.0					3.3	3.3	3.1	3.3	3.1	2.6	2.5
22.0						2.8	2.5	2.7	2.5	2.1	2.0
24.0							2.3	2.1	2.2	1.6	1.5
26.0								1.7	1.9	1.7	1.2
28.0								1.4	1.5	1.4	0.9
30.0									1.3	1.1	
32.0									1.0	0.8	
34.0										0.6	

\* Over rear · Nach hinten · A l'arrière · Hacia atrás · Indietro · Назад

\*\* With additional lifting equipment · Mit Zusatzhubausrüstung · Avec équipement de levage supplémentaire

Con equipamiento de elevación adicional · Con attrezzaggio di sollevamento supplementare · С дополнительным подъемным оборудованием



 m	9.5 m*	9.5 m	13.8 m	18.4 m	22.8 m	27.4 m	31.8 m	36.3 m	40.3 m	44.4 m	48.0 m
2.5	49.1**	45.0**	45.0**	44.3	34.3	23.2	15.2				
3.0	44.5	39.5	39.5	38.8	34.3	23.2	15.2				
3.5	38.4	34.9	35.3	34.3	34.1	23.2	15.2	13.6			
4.0	33.1	31.2	31.6	30.5	30.8	23.2	15.2	13.6			
4.5	29.1	28.1	28.4	28.0	27.7	23.2	15.2	13.6	9.4		
5.0	25.8	25.4	25.8	25.3	25.0	22.9	15.2	13.6	9.4		
6.0	20.9	20.9	21.6	21.3	19.9	17.8	15.2	13.6	9.4	7.7	6.3
7.0	16.0	16.0	16.9	16.6	16.2	15.3	13.8	12.5	9.4	7.7	6.3
8.0			13.6	13.7	13.6	12.7	12.3	10.6	9.4	7.7	6.3
9.0			11.1	11.2	11.1	11.6	10.7	9.9	8.9	7.7	6.3
10.0			9.2	9.8	9.9	9.8	9.3	8.9	8.0	7.4	6.3
11.0			7.9	8.3	8.5	8.3	8.3	7.9	7.6	6.7	6.3
12.0				7.2	7.5	7.4	7.2	7.4	6.8	5.9	5.6
14.0				5.6	5.8	5.7	5.5	5.7	5.4	4.6	4.4
16.0				4.4	4.6	4.5	4.3	4.5	4.3	3.6	3.5
18.0					3.8	3.7	3.5	3.6	3.5	2.9	2.7
20.0					3.0	3.0	2.8	3.0	2.8	2.2	2.1
22.0						2.5	2.3	2.4	2.3	1.7	1.6
24.0						2.1	1.8	2.0	1.8	1.3	1.2
26.0							1.5	1.6	1.5	1.0	
28.0							1.2	1.3	1.1		
30.0								1.1	0.9		
32.0								0.8	0.6		

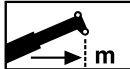

 m	9.5 m*	9.5 m	13.8 m	18.4 m	22.8 m	27.4 m	31.8 m	36.3 m	40.3 m	44.4 m	48.0 m
2.5	49.0**	44.1	44.2	43.5	34.3	23.2	15.2				
3.0	43.6	38.6	38.7	38.0	34.3	23.2	15.2				
3.5	36.8	34.1	34.5	33.4	33.3	23.2	15.2	13.6			
4.0	31.8	30.4	30.8	30.3	30.0	23.2	15.2	13.6			
4.5	27.9	27.3	27.7	27.2	25.5	23.1	15.2	13.6	9.4		
5.0	24.7	24.7	25.1	24.6	22.3	20.1	15.2	13.6	9.4		
6.0	18.8	18.8	19.8	19.3	17.9	16.6	14.7	13.1	9.4	7.7	6.3
7.0	13.8	13.8	15.1	15.2	14.6	13.5	12.4	10.6	9.4	7.7	6.3
8.0			11.8	12.0	11.9	11.8	10.8	10.0	8.8	7.7	6.3
9.0			9.6	10.2	10.3	10.0	9.5	8.7	8.0	7.3	6.3
10.0			8.0	8.5	8.7	8.5	8.1	8.1	7.5	6.4	6.1
11.0			6.7	7.2	7.5	7.4	7.1	7.0	6.5	5.5	5.3
12.0				6.2	6.5	6.4	6.2	6.2	5.7	4.8	4.6
14.0				4.7	5.0	4.9	4.7	4.9	4.5	3.7	3.5
16.0				3.7	3.9	3.8	3.6	3.8	3.6	2.8	2.7
18.0					3.1	3.1	2.9	3.0	2.8	2.1	2.0
20.0					2.4	2.5	2.3	2.4	2.2	1.6	1.5
22.0						2.0	1.8	1.9	1.8	1.1	
24.0						1.6	1.4	1.5	1.3		
26.0							1.0	1.2	1.0		
28.0							0.7	0.9	0.7		
30.0								0.7	0.7		
32.0								0.5			

\* Over rear · Nach hinten · A l'arrière · Hacia atrás · Indietro · Назад

\*\* With additional lifting equipment · Mit Zusatzhubausrüstung · Avec équipement de levage supplémentaire

Con equipamiento de elevación adicional · Con attrezzaggio di sollevamento supplementare · С дополнительным подъемным оборудованием

Operation · Einsatz · Utilisation  
 Uso · Эксплуатация

Working range · Arbeitsbereich · Rayon de travail  
 Zona de trabajo · Area di lavoro · Рабочая зона

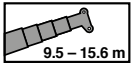





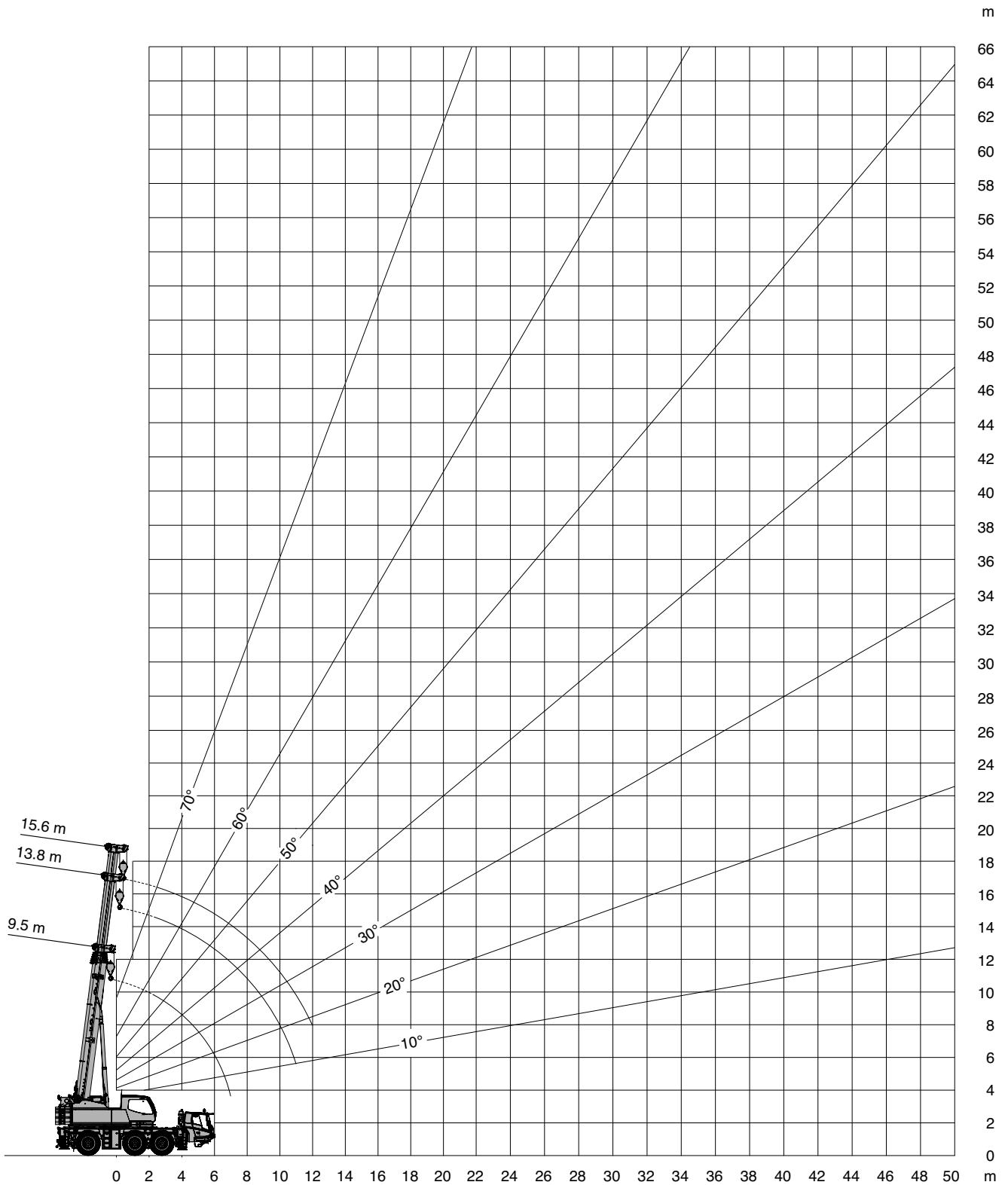



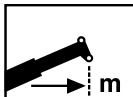

13 t

DIN/ISO/EN













Lifting capacities · Traglasten · Charges de levage  
 Cargas · Portate · Грузоподъемность













 m	9.5 m			13.8 m			15.6 m		
									
2.5		13.2			13.8			13.9	
3.0		11.6			12.2			12.4	
3.5		10.3			10.9			11.1	
4.0		9.2			9.9			10.0	
4.5	12.7	8.3			8.9			9.1	
5.0	11.4	7.5			8.1			8.3	
6.0	9.4	6.1		10.1	6.8		10.3	7.0	
7.0	7.9	5.1		8.6	5.8		8.8	5.9	
8.0				7.4	4.9		7.5	5.1	
9.0				6.4	4.2		6.6	4.4	
10.0				5.6	3.6		5.7	3.8	
11.0				4.9	3.2		5.1	3.3	
12.0							4.5	2.9	



 m	9.5 m			13.8 m			15.6 m		
									
2.5	17.9	12.1		18.6	12.7		18.8	12.8	
3.0	15.5	10.6		16.2	11.3		16.4	11.4	
3.5	13.5	9.4		14.3	10.0		14.5	10.2	
4.0	11.9	8.4		12.7	9.0		12.9	9.2	
4.5	10.6	7.5		11.4	8.2		11.6	8.3	
5.0	9.5	6.8		10.3	7.4		10.5	7.6	
6.0	7.7	5.5	3.1	8.5	6.2		8.7	6.3	
7.0	6.4	4.5	2.2	7.1	5.2		7.3	5.4	
8.0				6.0	4.4	2.3	6.2	4.6	2.5
9.0				5.2	3.7	1.7	5.4	3.9	1.9
10.0				4.5	3.2	1.3	4.6	3.4	1.5
11.0				3.9	2.8	0.9	4.1	2.9	1.1
12.0							3.5	2.5	0.8



 m	9.5 m			13.8 m			15.6 m		
									
2.5	15.9	11.4	6.7	16.7	12.0		16.7	12.2	
3.0	13.7	10.0	5.1	14.5	10.7		14.5	10.8	
3.5	12.0	8.9	4.0	12.7	9.5	4.3	12.7	9.7	4.3
4.0	10.5	7.9	3.1	11.3	8.5	3.5	11.3	8.7	3.6
4.5	9.3	7.0	2.4	10.1	7.7	2.9	10.1	7.9	3.0
5.0	8.3	6.3	1.8	9.1	7.0	2.4	9.1	7.1	2.5
6.0	6.7	5.1	0.9	7.4	5.8	1.6	7.4	6.0	1.7
7.0	5.4	4.2		6.2	4.8	1.0	6.2	5.0	1.1
8.0				5.2	4.1	0.5	5.2	4.3	0.7
9.0				4.4	3.5		4.4	3.6	
10.0				3.8	2.9		3.8	3.1	
11.0				3.3	2.5		3.3	2.7	
12.0								2.3	

Operation · Einsatz · Utilisation  
 Uso · Эксплуатация

Working range · Arbeitsbereich · Rayon de travail  
 Zona de trabajo · Area di lavoro · Рабочая зона

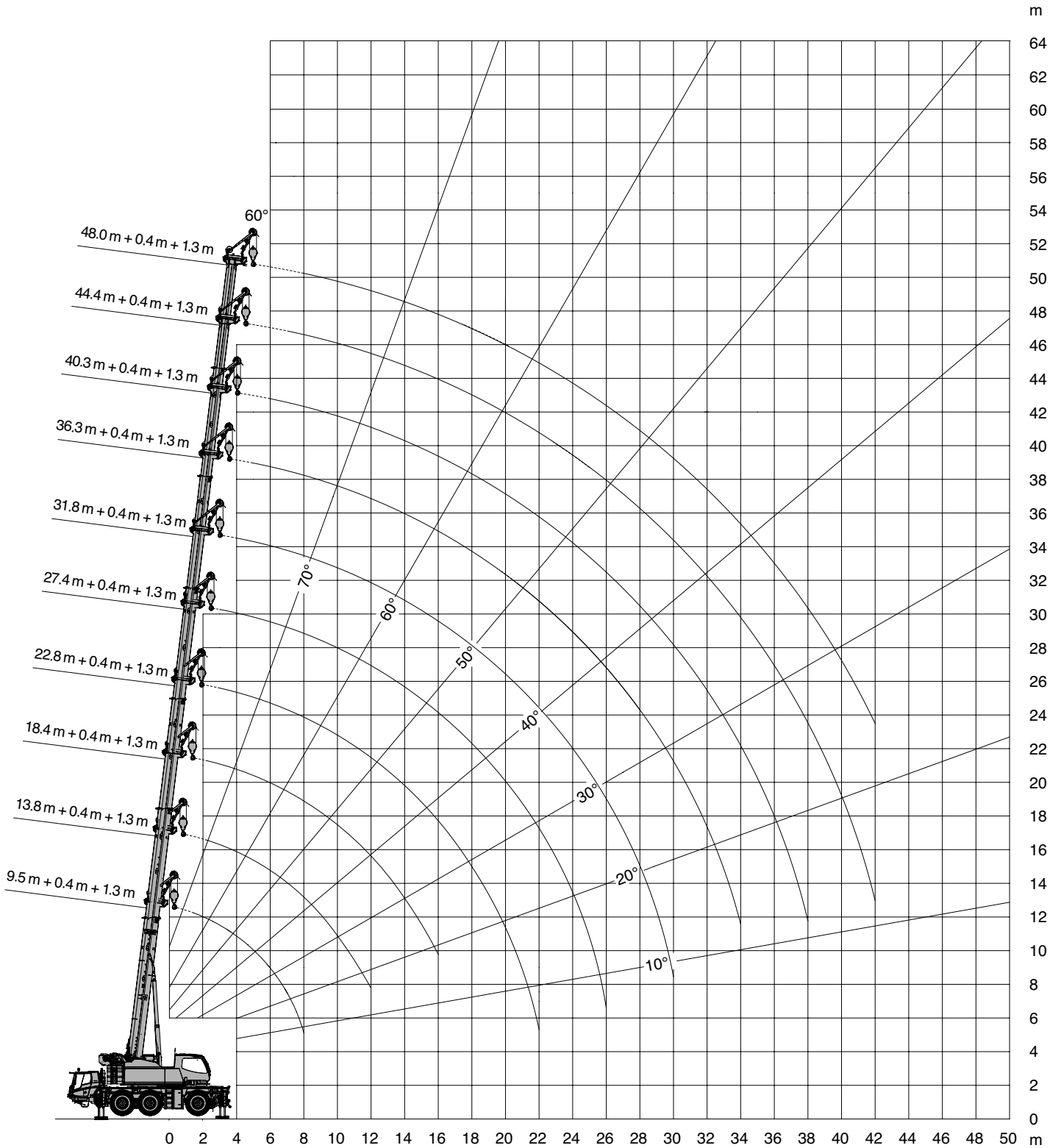
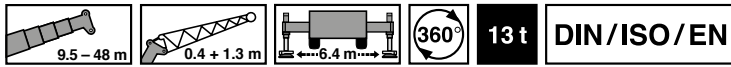



Lifting capacities · Traglasten · Charges de levage  
 Cargas · Portate · Грузоподъемность

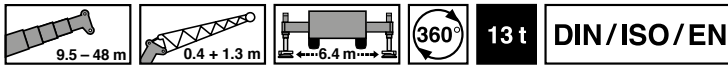

m	9.5 m + 0.4 m + 1.3 m			22.8 m + 0.4 m + 1.3 m			36.3 m + 0.4 m + 1.3 m			44.4 m + 0.4 m + 1.3 m			48.0 m + 0.4 m + 1.3 m		
	20°	40°	60°	20°	40°	60°	20°	40°	60°	20°	40°	60°	20°	40°	60°
2.5			25.8			26.2									
3.0			24.6			26.2									
3.5			23.5			25.0									
4.0		26.2	22.6			23.3									
4.5		25.5	21.8			21.7									
5.0		24.3	21.0			19.1			12.3						
6.0		22.3	19.8			17.0			12.3						
7.0	20.8	20.7	18.9			15.2			11.4				7.1		
8.0	18.2	18.3	18.4			13.8			10.4				7.1		5.7
9.0						12.6			9.5				7.1		5.7
10.0					9.9	11.5			8.7				7.1		5.7
11.0					11.6	10.6			7.9				6.8		5.7
12.0					10.6	8.3			6.7				5.8		5.5
14.0					8.2	6.5			5.7				5.1		4.8
16.0				4.4	6.4	5.4			4.9				4.4		4.2
18.0				5.4	5.4	4.8			4.2				3.9		3.7
20.0				4.7	4.8	4.0			3.5				3.4		3.3
22.0				4.0	4.0				2.9				3.0		2.9
24.0									2.3				2.7		2.6
26.0									2.0				2.3		2.3
28.0								2.0	2.0				2.0		2.1
30.0								1.8	1.8				1.6		1.8
32.0								1.6	1.6				1.7		1.8
34.0								1.5	1.5				1.4		1.5
36.0													1.1		1.2
38.0													0.9		1.0
40.0													0.7		0.8
42.0													0.6		0.6

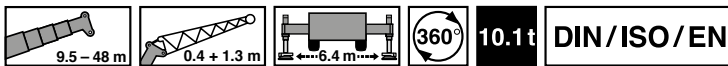

m	9.5 m + 0.4 m + 1.3 m			22.8 m + 0.4 m + 1.3 m			36.3 m + 0.4 m + 1.3 m			44.4 m + 0.4 m + 1.3 m			48.0 m + 0.4 m + 1.3 m		
	20°	40°	60°	20°	40°	60°	20°	40°	60°	20°	40°	60°	20°	40°	60°
2.5			25.8			26.2									
3.0			24.6			26.2									
3.5			23.5			25.0									
4.0		26.2	22.6			23.3									
4.5		25.5	21.8			21.7									
5.0		24.3	21.0			19.1			12.3						
6.0		22.3	19.8			17.0			12.3						
7.0	20.2	20.3	18.9			15.2			11.4				7.1		
8.0	17.6	17.7	17.8			13.8			10.4				7.1		5.7
9.0						12.6			9.5				7.1		5.7
10.0					9.9	11.0			8.7				7.1		5.7
11.0					10.8	9.4			7.9				6.8		5.7
12.0					9.3	7.1			6.7				5.8		5.5
14.0					7.1	6.2			5.7				5.1		4.8
16.0				4.4	6.1	5.0			4.5				4.4		4.2
18.0				5.0	5.0	4.5			3.6				3.9		3.7
20.0				4.5	4.5	3.8			2.8				3.4		3.3
22.0				3.8	3.8				2.5				2.8		2.9
24.0									2.2				2.3		2.4
26.0									2.0				1.8		2.0
28.0								2.0	2.0				1.9		2.0
30.0								1.8	1.8				1.5		1.6
32.0								1.6	1.6				1.2		1.3
34.0								1.5	1.5				0.9		1.1
36.0													0.7		0.8
38.0													0.6		0.6

Operation · Einsatz · Utilisation  
 Uso · Эксплуатация

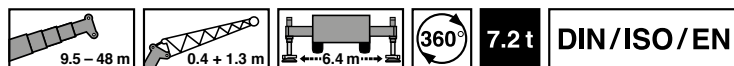

m	9.5 m + 0.4 m + 1.3 m			22.8 m + 0.4 m + 1.3 m			36.3 m + 0.4 m + 1.3 m			44.4 m + 0.4 m + 1.3 m			48.0 m + 0.4 m + 1.3 m		
	20°	40°	60°	20°	40°	60°	20°	40°	60°	20°	40°	60°	20°	40°	60°
2.5			25.8												
3.0			24.6			26.2									
3.5			23.5			26.2									
4.0		26.2	22.6			25.0									
4.5		25.5	21.8			23.3									
5.0		24.3	21.0			21.7			12.3						
6.0		22.3	19.8			19.1			12.3						
7.0	19.5	19.6	18.9			17.0			12.3			7.1			
8.0	16.9	17.0	17.0			15.2			11.4			7.1			5.7
9.0						13.4			10.4			7.1			5.7
10.0					9.9	11.1			9.5			7.1			5.7
11.0					9.2	9.4			8.7			7.1			5.7
12.0					8.3	8.3			7.9			6.8			5.7
14.0					6.5	6.6			6.2			5.8			5.5
16.0				4.4	5.7	5.7			4.8			5.1			4.8
18.0				4.5	4.6	4.6		3.8	3.8			4.2			4.2
20.0				3.7	3.8	3.8		3.3	3.3			3.4			3.5
22.0				3.2	3.2	3.2		2.8	2.8		2.7	2.7			2.9
24.0								2.5	2.5		2.1	2.2		2.3	2.3
26.0								2.2	2.2		1.7	1.7		1.8	1.9
28.0							2.0	2.0	2.0		1.3	1.3		1.4	1.5
30.0							1.8	1.8	1.8		1.0	1.0		1.1	1.2
32.0							1.5	1.5	1.5		0.7	0.7		0.8	0.9
34.0							1.3	1.3	1.3						

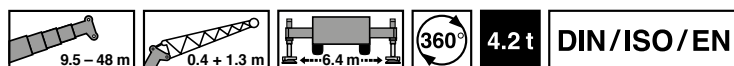

m	9.5 m + 0.4 m + 1.3 m			22.8 m + 0.4 m + 1.3 m			36.3 m + 0.4 m + 1.3 m			44.4 m + 0.4 m + 1.3 m			48.0 m + 0.4 m + 1.3 m		
	20°	40°	60°	20°	40°	60°	20°	40°	60°	20°	40°	60°	20°	40°	60°
2.5			25.8												
3.0			24.6			26.2									
3.5			23.5			26.2									
4.0		26.2	22.6			25.0									
4.5		25.5	21.8			23.3									
5.0		24.3	21.0			21.7			12.3						
6.0		22.0	19.8			19.1			12.3						
7.0	18.6	18.7	18.8			17.0			12.3			7.1			
8.0	14.9	15.0	15.1			13.9			11.4			7.1			5.7
9.0						11.4			10.2			7.1			5.7
10.0					9.9	9.8			8.7			7.1			5.7
11.0					8.4	8.5			7.5			7.1			5.7
12.0					7.6	7.5			6.5			6.6			5.7
14.0					6.0	6.0			5.2			5.2			5.2
16.0				4.4	4.7	4.7			4.4			4.1			4.1
18.0				4.0	4.0	4.0		3.7	3.7			3.2			3.3
20.0				3.4	3.5	3.5		3.2	3.2			2.5			2.6
22.0				2.9	2.9	2.9		2.8	2.8		1.9	2.0			2.1
24.0								2.3	2.4		1.5	1.5		1.6	1.6
26.0								1.9	1.9		1.1	1.1		1.2	1.2
28.0							1.6	1.6	1.6						
30.0							1.3	1.3	1.3						
32.0							1.0	1.1	1.1						
34.0							0.8	0.8	0.8						

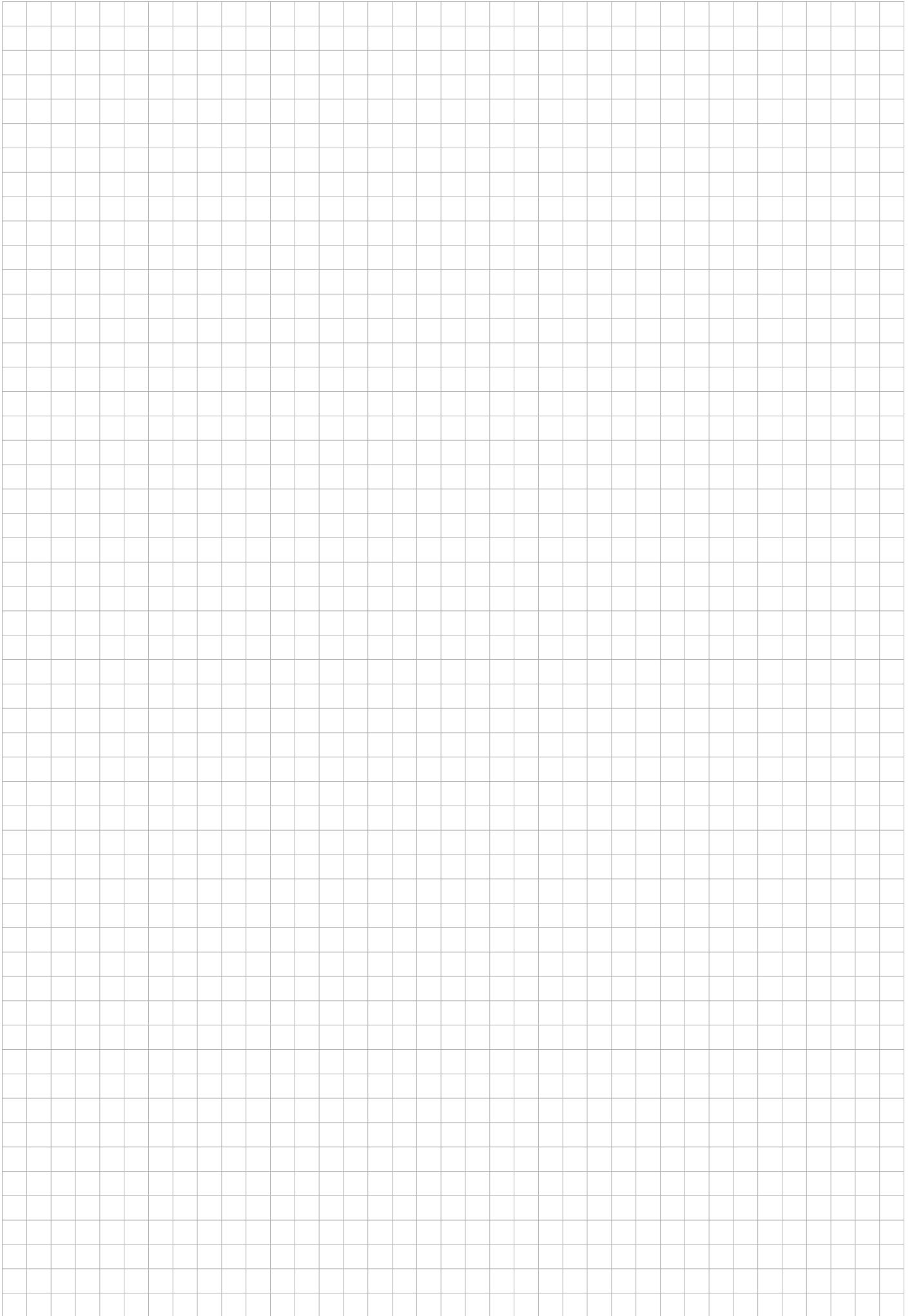

Operation · Einsatz · Utilisation  
 Uso · Эксплуатация

Working range · Arbeitsbereich · Rayon de travail  
 Zona de trabajo · Area di lavoro · Рабочая зона

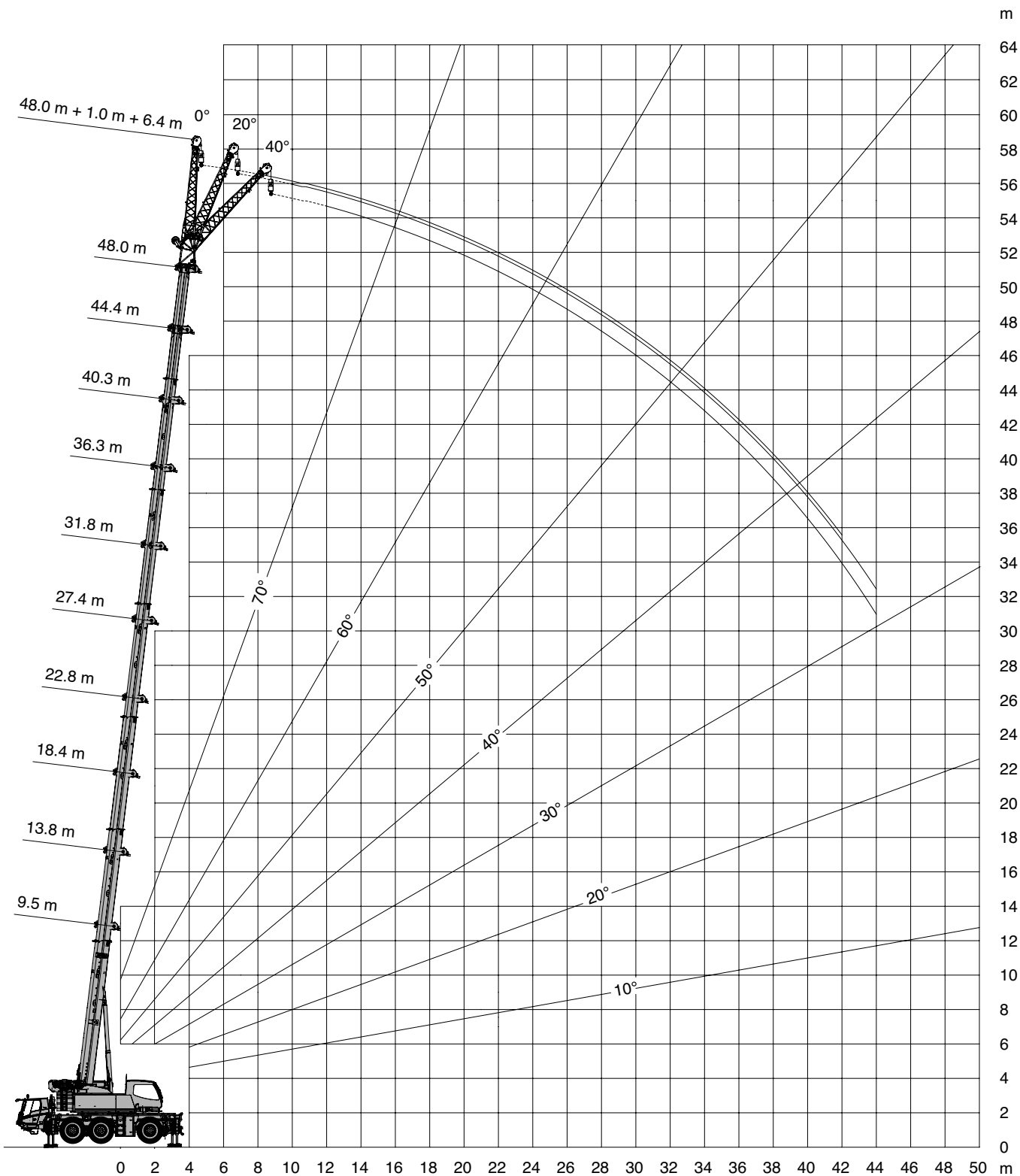
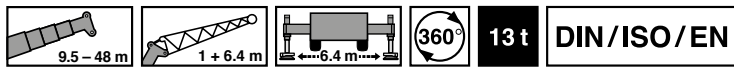

Lifting capacities · Traglasten · Charges de levage  
Cargas · Portate · Грузоподъемность

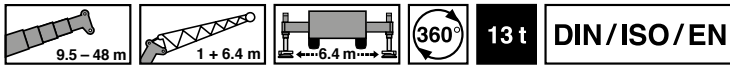

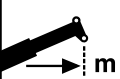
 m	9.5 m + 1.0 m + 6.4 m			22.8 m + 1.0 m + 6.4 m			36.3 m + 1.0 m + 6.4 m			44.4 m + 1.0 m + 6.4 m			48.0 m + 1.0 m + 6.4 m		
	0°	20°	40°	0°	20°	40°	0°	20°	40°	0°	20°	40°	0°	20°	40°
2.5	11.0			11.0											
3.0	11.0	11.0		11.0											
3.5	11.0	11.0		11.0											
4.0	11.0	10.5		11.0	11.0		7.8								
4.5	11.0	10.0		11.0	10.8		7.8								
5.0	11.0	9.6	7.8	11.0	10.5		7.8								
6.0	11.0	8.9	7.4	11.0	10.0	7.7	7.8								
7.0	10.5	8.3	7.1	11.0	9.5	7.4	7.8	7.8		4.1					
8.0	9.6	7.8	6.7	11.0	9.1	7.2	7.8	7.8		4.1			3.4		
9.0	8.8	7.3	6.5	11.0	8.7	7.0	7.8	7.8	6.8	4.1	4.1		3.4		
10.0	8.2	7.0	6.3	11.0	8.4	6.9	7.8	7.8	6.6	4.1	4.1		3.4	3.4	
11.0	7.6	6.7	6.1	11.0	8.1	6.7	7.8	7.8	6.5	4.1	4.1	4.1	3.4	3.4	
12.0	7.1	6.4	6.0	10.5	7.8	6.5	7.8	7.6	6.4	4.1	4.1	4.1	3.4	3.4	3.4
14.0	6.2	6.0		8.9	7.3	6.3	7.7	7.2	6.1	4.1	4.1	4.1	3.4	3.4	3.4
16.0				7.7	6.9	6.1	6.9	6.7	5.9	4.1	4.1	4.1	3.4	3.4	3.4
18.0				6.3	6.5	5.9	5.7	6.1	5.8	4.1	4.1	4.1	3.4	3.4	3.4
20.0				5.7	5.6	5.7	4.7	5.0	5.2	4.1	4.1	4.1	3.4	3.4	3.4
22.0				4.9	5.1	5.0	4.1	4.2	4.4	4.1	4.1	4.1	3.4	3.4	3.4
24.0				4.2	4.4		3.8	3.8	3.8	3.5	3.8	3.9	3.4	3.4	3.4
26.0				3.7	3.8		3.3	3.5	3.5	3.0	3.2	3.4	3.1	3.3	3.4
28.0							3.0	3.0	3.1	2.5	2.7	2.9	2.6	2.8	3.0
30.0							2.8	2.8	2.8	2.1	2.3	2.4	2.2	2.4	2.5
32.0							2.6	2.6	2.6	1.8	1.9	2.0	1.9	2.0	2.2
34.0							2.3	2.4	2.4	1.5	1.6	1.7	1.6	1.7	1.8
36.0								2.1		1.2	1.4	1.4	1.3	1.5	1.5
38.0								1.8		1.0	1.1	1.2	1.1	1.2	1.3
40.0										0.8	0.9	0.9	0.9	1.0	1.1
42.0										0.6	0.7		0.7	0.8	0.8
44.0													0.6	0.7	0.7

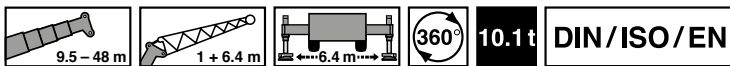

 m	9.5 m + 1.0 m + 6.4 m			22.8 m + 1.0 m + 6.4 m			36.3 m + 1.0 m + 6.4 m			44.4 m + 1.0 m + 6.4 m			48.0 m + 1.0 m + 6.4 m		
	0°	20°	40°	0°	20°	40°	0°	20°	40°	0°	20°	40°	0°	20°	40°
2.5	11.0			11.0											
3.0	11.0	11.0		11.0											
3.5	11.0	11.0		11.0											
4.0	11.0	10.5		11.0	11.0		7.8								
4.5	11.0	10.0		11.0	10.8		7.8								
5.0	11.0	9.6	7.8	11.0	10.5		7.8								
6.0	11.0	8.9	7.4	11.0	10.0	7.7	7.8								
7.0	10.5	8.3	7.1	11.0	9.5	7.4	7.8	7.8		4.1					
8.0	9.6	7.8	6.7	11.0	9.1	7.2	7.8	7.8		4.1			3.4		
9.0	8.8	7.3	6.5	11.0	8.7	7.0	7.8	7.8	6.8	4.1	4.1		3.4		
10.0	8.2	7.0	6.3	11.0	8.4	6.9	7.8	7.8	6.6	4.1	4.1		3.4	3.4	
11.0	7.6	6.7	6.1	11.0	8.1	6.7	7.8	7.8	6.5	4.1	4.1	4.1	3.4	3.4	
12.0	7.1	6.4	6.0	10.0	7.8	6.5	7.8	7.6	6.4	4.1	4.1	4.1	3.4	3.4	3.4
14.0	6.2	6.0		8.3	7.3	6.3	7.4	7.2	6.1	4.1	4.1	4.1	3.4	3.4	3.4
16.0				7.0	6.8	6.1	6.0	6.5	5.9	4.1	4.1	4.1	3.4	3.4	3.4
18.0				5.9	6.1	5.9	5.1	5.2	5.5	4.1	4.1	4.1	3.4	3.4	3.4
20.0				5.0	5.2	5.3	4.6	4.6	4.6	4.1	4.1	4.1	3.4	3.4	3.4
22.0				4.2	4.4	4.5	3.8	4.0	4.2	3.5	3.8	4.0	3.4	3.4	3.4
24.0				3.8	3.8		3.5	3.4	3.6	2.9	3.2	3.3	3.0	3.3	3.4
26.0				3.5	3.5		3.2	3.2	3.2	2.4	2.6	2.8	2.5	2.7	2.9
28.0							2.8	2.9	3.0	2.0	2.2	2.3	2.1	2.3	2.4
30.0							2.4	2.5	2.6	1.6	1.8	1.9	1.7	1.9	2.0
32.0							2.1	2.2	2.3	1.3	1.5	1.6	1.4	1.6	1.7
34.0							1.9	1.9	2.0	1.1	1.2	1.3	1.2	1.3	1.4
36.0								1.7		0.8	1.0	1.0	0.9	1.1	1.1
38.0								1.5		0.6	0.7	0.8	0.7	0.8	0.9
40.0											0.5	0.6	0.5	0.6	0.7
42.0															0.5

Operation · Einsatz · Utilisation  
 Uso · Эксплуатация

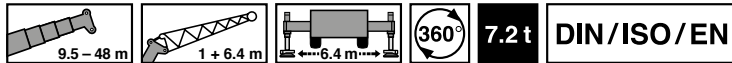

m	9.5 m + 1.0 m + 6.4 m			22.8 m + 1.0 m + 6.4 m			36.3 m + 1.0 m + 6.4 m			44.4 m + 1.0 m + 6.4 m			48.0 m + 1.0 m + 6.4 m		
	0°	20°	40°	0°	20°	40°	0°	20°	40°	0°	20°	40°	0°	20°	40°
2.5	11.0			11.0											
3.0	11.0	11.0		11.0											
3.5	11.0	11.0		11.0											
4.0	11.0	10.5		11.0	11.0		7.8								
4.5	11.0	10.0		11.0	10.8		7.8								
5.0	11.0	9.6	7.8	11.0	10.5		7.8								
6.0	11.0	8.9	7.4	11.0	10.0	7.7	7.8								
7.0	10.5	8.3	7.1	11.0	9.5	7.4	7.8	7.8		4.1					
8.0	9.6	7.8	6.7	11.0	9.1	7.2	7.8	7.8		4.1			3.4		
9.0	8.8	7.3	6.5	11.0	8.7	7.0	7.8	7.8	6.8	4.1	4.1		3.4		
10.0	8.2	7.0	6.3	11.0	8.4	6.9	7.8	7.8	6.6	4.1	4.1		3.4	3.4	
11.0	7.6	6.7	6.1	10.6	8.1	6.7	7.8	7.8	6.5	4.1	4.1	4.1	3.4	3.4	
12.0	7.1	6.4	6.0	9.2	7.8	6.5	7.7	7.6	6.4	4.1	4.1	4.1	3.4	3.4	3.4
14.0	6.2	6.0		7.6	7.3	6.3	6.3	6.6	6.1	4.1	4.1	4.1	3.4	3.4	3.4
16.0				6.1	6.4	6.0	5.6	5.6	5.7	4.1	4.1	4.1	3.4	3.4	3.4
18.0				5.0	5.3	5.4	4.6	4.9	5.1	4.1	4.1	4.1	3.4	3.4	3.4
20.0				4.5	4.4	4.5	4.1	4.1	4.3	3.4	3.7	3.9	3.4	3.4	3.4
22.0				3.9	4.0	4.0	3.7	3.7	3.7	2.8	3.0	3.3	2.8	3.1	3.3
24.0				3.4	3.5		3.1	3.3	3.4	2.3	2.5	2.7	2.3	2.6	2.8
26.0				2.9	3.0		2.7	2.8	2.9	1.8	2.1	2.2	1.9	2.1	2.3
28.0							2.3	2.4	2.5	1.5	1.7	1.8	1.5	1.7	1.9
30.0							2.0	2.1	2.1	1.1	1.3	1.4	1.2	1.4	1.5
32.0							1.7	1.8	1.8	0.9	1.0	1.1	1.0	1.1	1.2
34.0							1.4	1.5	1.5	0.6	0.8	0.9	0.7	0.9	1.0
36.0								1.3			0.5	0.6	0.5	0.6	0.7
38.0								1.1							0.5

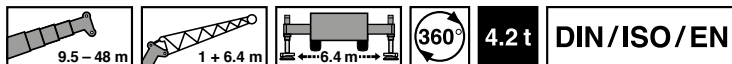

m	9.5 m + 1.0 m + 6.4 m			22.8 m + 1.0 m + 6.4 m			36.3 m + 1.0 m + 6.4 m			44.4 m + 1.0 m + 6.4 m			48.0 m + 1.0 m + 6.4 m		
	0°	20°	40°	0°	20°	40°	0°	20°	40°	0°	20°	40°	0°	20°	40°
2.5	11.0			11.0											
3.0	11.0	11.0		11.0											
3.5	11.0	11.0		11.0											
4.0	11.0	10.5		11.0	11.0		7.8								
4.5	11.0	10.0		11.0	10.8		7.8								
5.0	11.0	9.6	7.8	11.0	10.5		7.8								
6.0	11.0	8.9	7.4	11.0	10.0	7.7	7.8								
7.0	10.5	8.3	7.1	11.0	9.5	7.4	7.8	7.8		4.1					
8.0	9.6	7.8	6.7	11.0	9.1	7.2	7.8	7.8		4.1			3.4		
9.0	8.8	7.3	6.5	11.0	8.7	7.0	7.8	7.8	6.8	4.1	4.1		3.4		
10.0	8.2	7.0	6.3	10.4	8.4	6.9	7.8	7.8	6.6	4.1	4.1		3.4	3.4	
11.0	7.6	6.7	6.1	9.4	8.1	6.7	7.1	7.8	6.5	4.1	4.1	4.1	3.4	3.4	
12.0	7.1	6.4	6.0	8.3	7.8	6.5	6.3	6.8	6.4	4.1	4.1	4.1	3.4	3.4	3.4
14.0	6.2	6.0		6.4	6.8	6.3	5.6	6.1	5.9	4.1	4.1	4.1	3.4	3.4	3.4
16.0				5.5	5.4	5.6	4.5	4.9	5.3	3.9	4.1	4.1	3.4	3.4	3.4
18.0				4.6	4.8	4.8	4.3	4.3	4.3	3.1	3.4	3.8	3.1	3.4	3.4
20.0				3.8	4.0	4.1	3.6	3.8	3.9	2.4	2.8	3.0	2.5	2.8	3.1
22.0				3.3	3.4	3.4	3.0	3.2	3.3	1.9	2.2	2.4	2.0	2.3	2.5
24.0				2.8	2.9		2.5	2.6	2.8	1.5	1.7	1.9	1.6	1.8	2.0
26.0				2.4	2.5		2.1	2.2	2.3	1.1	1.3	1.5	1.2	1.4	1.6
28.0							1.7	1.9	1.9	0.8	1.0	1.2	0.9	1.1	1.2
30.0							1.5	1.6	1.6	0.5	0.7	0.8	0.6	0.8	0.9
32.0							1.2	1.3	1.3			0.6		0.5	0.7
34.0							1.0	1.1	1.1						
36.0								0.9							
38.0								0.7							

# EQUIPMENT

AUSSTATTUNG

ÉQUIPEMENT

EQUIPAMIENTO

EQUIPAGGIAMENTO

ОБОРУДОВАНИЕ



# Equipment

## Carrier

**Frame:** Torsion-resistant, welded construction made from high strength, fine-grained steel. Central lubricating system.

**Outriggers:** 4-point telescopic hydraulic outriggers incl. asymmetric outrigger base and automatic length detection. Controls on both sides of carrier and in superstructure cab. Outrigger base 6.4 m (5.4 m / 4.4 m / 2.4 m) x 7.2 m.

**Engine:** No separate carrier engine; travel drive from the superstructure engine.

**Transmission:** Mechanical transmission integrated in engine block, installed in superstructure, power driving the carrier is transferred via miter gear and drive shafts.

**Transfer case:** Power transferred via drive shaft from superstructure through the crane's center of rotation, with differential and differential lock.

**Drive:** 6 x 6

### Axles:

1<sup>st</sup> axle: steered, driven, with differential lock, transverse.

2<sup>nd</sup> axle: steered, driven, with differential lock, transverse.

3<sup>rd</sup> axle: steered, driven, with differential lock, transverse.

**Suspension:** Hydro-pneumatic with levelling adjustment. Suspension cylinders electro-hydraulically lockable.

**Brake system:** Air-operated dual-circuit brake system with ABS system and air drier. Parking brake: spring loaded type acting on 2<sup>nd</sup> and 3<sup>rd</sup> axles, engine brake as continuous service brake.

**Tyres:** 6 steel disc wheels 11.00-25/1.7, tyres 445/95 R25 174F (16.00 R 25).

**Steering system:** ZF Servocom dual-circuit hydraulic power steering, mechanical with hydraulic assistance. Steering is effective with mechanical connection on the 1<sup>st</sup> and 2<sup>nd</sup> axles. In on-road mode, the 3<sup>rd</sup> axle is locked in straight-ahead position. On the construction site, the 3<sup>rd</sup> axle can be unlocked and steered automatically via a pushbutton in the driver's cab. Driving over short distances from the superstructure is possible.

**Carrier cab:** Two man full width cab of composite (steel sheet metal and fibre-glass) structure, with safety glass, air-cushioned adjustable seats (driver's seat with heater) and engine-independent water heater, air-conditioning, radio / CD-player, complete controls and instrumentation for road travel. Cruise control.

**Electrical system:** 24 V DC system. Bi-halogen main headlights for dimmed and high-beam light, LED daytime running lights, 2 LED fog lights, lateral lights, 2 rear seven-compartment lamps with rear fog light and reversing light. Acoustic back-up alarm. 2 rotary beacons on the carrier cab. 4 headlamps for lighting of the area of the extended outriggers; can also be switched from the carrier cab. Wiring with CAN bus components, integrated self-diagnosis CSS (Control & Service System).

**Optional equipment:** (at extra charge)

Towing attachment, Eddy-current brake on the 3<sup>rd</sup> axle, tool box, monitoring of outrigger pressure, tyre pressure monitoring system, tyres 385/95 R25 170F (14.00 R 25), 525/80 R25 176F (20.5 R 25), special painting and lettering. Further optional equipment available upon request.

## Superstructure

**Frame:** Torsion-resistant, all-welded structure. Connected to carrier by single-row, ball-bearing slewing ring with external gearing for 360° continuous rotation. Central lubricating system.

**Engine:** Mercedes-Benz 6-cylinder diesel engine, type OM936LA, certified for EUROMOT IV or EPA Tier 4f, water-cooled, hydrostatically driven and electronically controlled fan. Engine displacement 7.7 l, power output 260 kW (354 HP) at 2200 rpm, torque 1400 Nm at 1200 rpm to 1600 rpm. Engine speed during crane work max. 1800 rpm. Fuel tank: 280 l. AdBlue tank: 40 l.

**Gearbox:** Main transmission: mechanical ZF AS-Tronic transmission, type mid 12 AS 1625 SO, with electro-pneumatically actuated dry clutch and fully automatic transmission control system. 12 forward gears and 2 reverse gears. If necessary, semi-automatic mode (Tip-Tronic) is possible with manual gear selection.

**Hydraulic system:** Diesel-hydraulic system with 2 hydraulic circuits, 1 axial-piston pump with constant engine for telescoping, boom elevation and hoisting gear and 1 axial-piston pump (electro-hydraulically adjustable) for the swing mechanism and 1 axial-piston pump (electro-hydraulically adjustable) which can be connected for accumulative power control for telescoping.

**Controls:** Electrical, 2 joy-stick levers for simultaneous operation of crane motions.

**Telescopic boom:** 7 sections, made of high tensile, fine-grained steel, consisting of 1 base section and 6 telescoping sections extended by means of a single telescopic cylinder. All telescope sections extendable under partial load. 9.5 m to 48.0 m long. Boom head with 4 sheaves.

**Boom elevation:** 1 differential cylinder with integral brake and holding valve.

**Main winch:** Axial-piston constant motor, winch drum with integrated planetary reduction and hydraulically controlled spring-loaded multiple disc brake and integrated free rotation (no sagging of load when hoisting), drum rotation indicator. Hoist cable with 'Super-Stop' easy reeving system.

**Slewing system:** Axial piston constant motor with two-stage planetary reduction with a foot-actuated service and a parking brake.

**Counterweight:** Standard 5.1 t divisible (LMB programs for 0 t, 2.1 t, 4.2 t, 5 t (5.1 t)). Controlled from superstructure cab.

**Superstructure cab:** Spacious panoramic cab of composite structure with safety (tinted) glass windows, tiltable cockpit with mechanically cushioned adjustable seat with heater, engine independent heater with engine pre-heat, air conditioning, radio / CD-player, complete controls and instrumentation for crane operation, on-site travelling and outriggers.

**Electrical system:** 24 V DC system with 100 A three-phase generator, 2 batteries, 12 V, 170 Ah each, 2 rotary beacons on the rotary platform, on the rear left and right side, near the hoisting gear, 2 rear position lamps, 2 working floodlights integrated in the superstructure cab, 1 working floodlight on the base boom, 2 lateral lights on the boom head.

**Safety devices:** Electronic load moment limiter (LMB), slewing area and working area limitation with "Slow-Stop" feature, hoist limit switch, winch limit switch, safety valves protect against pipe and hose failures.

**Optional equipment:** (at extra charge)

Jib 1 m + 6.4 m, offsets 0°, 20° and 40°, heavy duty fly jib 0.4 m + 1.3 m, additional counterweight 7.9 t, selection of hook blocks, 2<sup>nd</sup> winch, special painting and lettering. Further optional equipment available upon request.



## Unterwagen

**Rahmen:** Verwindungs- und biegesteife Schweißkonstruktion aus hochfestem Feinkornstahl. Zentralschmieranlage.

**Abstützung:** Hydraulische 4-Punkt-Teleskopabstützung, inkl. asymmetrischer Abstützbasis und automatischer Längenerkennung, Bedienungsmöglichkeiten an beiden Seiten des Fahrgestelles und in der Oberwagenkabine. Abstützbasis 6,4 m (5,4 m / 4,4 m / 2,4 m) x 7,2 m.

**Motor:** Kein separater Unterwagenmotor vorhanden, Fahrtrieb über Motor im Oberwagen.

**Getriebe:** Getriebe mit Motor verblockt im Oberwagen eingebaut, über Winkelgetriebe und Gelenkwellen Antrieb zum Unterwagen.

**Verteilergetriebe:** Antrieb durch Gelenkwelle vom Oberwagen durch die Drehmitte des Kranes, mit Differential und Differentialsperre.

**Antrieb:** 6 x 6

**Achsen:**

1. Achse: gelenkt, angetrieben, Differentialsperre quer.
2. Achse: gelenkt, angetrieben, Differentialsperre quer.
3. Achse: gelenkt, angetrieben, Differentialsperre quer.

**Achsaufhängung:** Hydropneumatische Federung mit Niveau-regulierung. Federungszyylinder elektro-hydraulisch blockierbar.

**Bremsen:** Druckluft-Zweikreis-Bremsanlage mit ABS-System und Lufttrockner. Feststellbremse als Federspeicherbremse an der 2. und 3. Achse wirkend, Motorbremse als Dauerbremse.

**Räder:** 6-fach Stahlblech-Scheibenräder 11.00-25/1.7; Reifen 445/95 R25 174F (16.00 R 25).

**Lenkung:** ZF-Servocom-Zweikreislenkung, mechanisch, hydraulisch unterstützt. Gelenk wird mit mechanischer Verbindung die 1. und 2. Achse. Im Straßenfahrmodus ist die 3. Achse in Geradeausstellung verriegelt. Auf der Baustelle kann die 3. Achse entriegelt und über einen Taster im Fahrerhaus mitgelenkt werden. Das Verfahren vom Oberwagen aus ist möglich.

**Unterwagenkabine:** Zwei-Mann-Frontfahrerhaus in Stahl-Kunststoff-Verbund-Konstruktion, Sicherheitsverglasung, luftgefederte Sitze (Fahrersitz mit Heizung) und motorunabhängige Wasserheizung, Klimaanlage, Radio / CD-Player, Kontroll- und Bedienungselemente für den Fahrbetrieb. Tempomat-Funktion.

**Elektrische Anlage:** 24 Volt Gleichstromanlage. Bi-Halogen-Hauptscheinwerfer für Abblend- und Fernlicht, LED-Tagfahrlicht, 2 LED-Nebelscheinwerfer, Seitenleuchten, 2 Siebenkammerleuchten hinten mit Nebelschlussleuchte und Rückfahrcheinwerfer. Akustischer Rückfahralarm. 2 Rundumkennleuchten auf der Unterwagenkabine. 4 Scheinwerfer für Abstützfeldbeleuchtung, schaltbar auch aus Unterwagenkabine. Verdrahtung mit CAN-Bus-Komponenten, integrierte Eigendiagnose CSS (Control & Service System).

**Zusatzrüstung:** (gegen Mehrpreis)

Anhängekupplung, Wirbelstrombremse an 3. Achse, Werkzeugkasten, Abstützdruckanzeige, Reifendrucküberwachung, Bereifung 385/95 R25 170F (14.00 R 25), 525/80 R25 176F (20.5 R 25). Sonderlackierung und Beschriftung. Weitere Zusatzrüstung auf Anfrage.

## Oberwagen

**Rahmen:** Verwindungssteife Schweißkonstruktion mit einer außenverzahnten, einreihigen Kugeldrehverbindung, um 360° unbegrenzt drehbar. Zentralschmieranlage.

**Motor:** Mercedes-Benz 6-Zylinder-Dieselmotor OM936LA, zertifiziert für EUROMOT IV oder EPA Tier 4f, wassergekühlt, hydrostatisch angetriebener Lüfter mit elektronischer Regelung. Hubraum 7,7 l, Leistung 260 kW (354 PS) bei 2200 min<sup>-1</sup>, Drehmoment 1400 Nm bei 1200 min<sup>-1</sup> bis 1600 min<sup>-1</sup>, Motordrehzahl bei Kranarbeit begrenzt auf max. 1800 min<sup>-1</sup>. Kraftstoffbehälter: 280 l. AdBlue-Behälter: 40 l.

**Getriebe:** Hauptgetriebe ZF-AS-Tronic mid 12 AS 1625 SO, mechanisches Schaltgetriebe mit elektronisch-pneumatisch betätigter Trockenkupplung und vollautomatischer Schaltung mit 12 Vorwärts- und 2 Rückwärtsgängen. Bei Bedarf teilautomatischer Betrieb (Tip-Tronic) mit manueller Gangwahl möglich.

**Hydraulik System:** Diesel-hydraulisch mit 2-Kreis-Hydraulik, Ölkühler, 1 Axialkolbenpumpe mit Konstantmotor für Teleskopieren, Wippen und Hubwerk und 1 Axialkolbenpumpe (elektro-hydraulisch verstellbar) für Drehwerk und 1 Axialkolbenpumpe (elektro-hydraulisch verstellbar) zuschaltbar für Summenfunktion Teleskopieren.

**Steuerung:** Zwei 4-fach Kreuzsteuerhebel mit elektrischer Vorsteuerung.

**Teleskopausleger:** Siebenteiliger Teleskopausleger aus hochfestem Feinkornstahl, bestehend aus einem Grundauser und 6 Teleskopteilen, 1 Teleskopzylinder, hydraulisch unter Teillast teleskopierbar. 9,5 m – 48,0 m lang. Rollenkopf mit 4 Seilrollen.

**Wippwerk:** Ein Differentialzylinder mit angebautem Senkbremsventil.

**Hubwerk:** Axialkolben-Konstant-Motor, Hubwerkstrommel mit eingebautem Planetengetriebe und federbelasteter Hydro-Lamellenbremse mit integriertem Freilauf beim Heben, Seilwindendrehmelder. Hubseil mit 'Super-Stop' Einrichtung.

**Drehwerk:** Axialkolben-Motor, zweistufiges Planetengetriebe mit fußbetätigter Betriebsbremse und Feststellung.

**Gegengewicht:** Standard 5,1 t teilbar (LMB-Programme für 0 t, 2,1 t, 4,2 t, 5 t (5,1 t)). Die Bedienung erfolgt aus der Oberwagenkabine.

**Oberwagenkabine:** Großräumige Krankabine in Stahl-Kunststoff-Ausführung mit Sicherheitsverglasung und getönten Scheiben, kippbarem Arbeitsplatz mit verstellbarem, mechanisch gedämpftem Fahrersitz mit Heizung, motorunabhängige Heizung mit Motorvorwärmung, Klimaanlage, Radio / CD-Player, Kontroll- und Bedienungselemente für Kranbetrieb, Abstützbetätigung und Verfahrbarkeit vom Oberwagen.

**Elektrische Anlage:** 24 Volt-Gleichstromanlage mit 100 Ampere Drehstromlichtmaschine, 2 Batterien mit je 12 Volt 170Ah, 2 Rundumkennleuchten hinten links und rechts am Drehtisch neben dem Hubwerk, 2 Positionsleuchten hinten, 2 Arbeitsscheinwerfer integriert in die Oberwagenkabine, 1 Arbeitsscheinwerfer am Grundauser, 2 Seitenleuchten am Auslegerkopf.

**Sicherheitseinrichtungen:** Elektronische Lastmomentbegrenzung (LMB), Dreh- und Arbeitsbereichsbegrenzung mit 'Slow-Stop' Funktion, Hubendschalter, Windenendschalter, Sicherheitsventile gegen Rohr- und Schlauchbrüche.

**Zusatzrüstung:** (gegen Mehrpreis)

Auslegerverlängerung 1 m + 6,4 m, wahlweise abwinkelbar 0°, 20° und 40°, Schwerlastspitze 0,4 m + 1,3 m, Zusatzgegengewicht 7,9 t, verschiedene Unterflaschen, 2. Hubwerk, Sonderlackierung und Beschriftung. Weitere Zusatzrüstung auf Anfrage.

# Équipement

## Châssis

**Châssis:** Construction mécano-soudée, en acier à grain fin très rigide, résistant aux flexions et aux torsions. Système de graissage centralisé.

**Calage:** Dispositif de calage horizontal et vertical en 4 points, entièrement déployable hydrauliquement, y compris distance entre appuis asymétrique et détection de longueur automatique, commande des mouvements sur les deux côtés du porteur et depuis la cabine de la superstructure. Calage 6,4 m (5,4 m / 4,4 m / 2,4 m) x 7,2 m.

**Moteur:** Aucun moteur du châssis à part; transmission par l'intermédiaire du moteur de la superstructure.

**Boîte de vitesses:** Boîte de vitesses montée sur le bloc moteur dans la superstructure, entraînement transmis au châssis au moyen d'un engrenage angulaire et arbres à cardans.

**Boîte de transfert:** Entraînement par arbre à cardans à partir de la superstructure par le centre de rotation de la grue, avec différentiel et blocage de différentiel.

**Entraînement:** 6 x 6

### Essieux:

1<sup>er</sup> essieu: directeur, entraîné, blocage de différentiel transversal.

2<sup>ème</sup> essieu: directeur, entraîné, blocage de différentiel transversal.

3<sup>ème</sup> essieu: directeur, entraîné, blocage de différentiel transversal.

**Suspension des essieux:** Hydro-pneumatique, avec réglage du niveau. Vérins de suspension blocables électro-hydrauliquement.

**Freins:** Système de freinage à air comprimé, à double circuit, avec système ABS et sécheur d'air. Frein de stationnement: avec accumulateurs à ressort agissant sur les essieux 2 et 3, frein moteur conçu comme frein continu.

**Pneus:** 6 roues à disque en tôle d'acier de 11.00-25/1.7; pneus 445/95 R25 174F (16.00 R 25).

**Direction:** Marque ZF Servocom hydraulique à double circuit; direction mécanique, à assistance hydraulique. La direction est efficace à l'aide d'une connexion mécanique, sur les 1<sup>er</sup> et 2<sup>ème</sup> essieux. En mode de marche route, le 3<sup>ème</sup> essieu est verrouillé en position "ligne droite". Sur chantier, le 3<sup>ème</sup> essieu peut être déverrouillé et dirigé automatiquement par un bouton-poussoir dans la cabine. Il est possible de déplacer l'engin à partir de la superstructure.

**Cabine:** Cabine bi-place frontale, construction en matière composite acier / synthétique, vitrage en verre de sécurité, sièges suspendus pneumatiquement (siège conducteur chauffant). Chauffage à eau chaude autonome, climatisation, radio / CD player, éléments de contrôle et de commande pour la conduite. Régulateur de vitesse.

**Système électrique:** 24 V courant continu. Phares principaux Bi-halogènes pour l'éclairage code et route, feux de circulation diurne (DEL), 2 feux-brouillard (DEL), feux latéraux, 2 feux à sept compartiments à l'arrière, comprenant le feu-brouillard AR et le phare de recul. Alarme de recul acoustique. 2 gyrophares sur la cabine du châssis. 4 phares pour l'éclairage de la zone d'appui, pouvant être commutés à partir de la cabine du châssis. Câblage avec composants du bus CAN, autodiagnostic intégré CSS (Control & Service System).

**Équipement supplémentaire:** (avec supplément de prix) Attache-remorque, ralentisseur sur le 3<sup>ème</sup> essieu, boîte à outils, affichage de la pression d'appui, contrôle de la pression des pneus, pneus 385/95 R25 170F (14.00 R 25), 525/80 R25 176F (20.5 R 25). Peinture spéciale et inscription. Autres équipements supplémentaires sur demande.

## Superstructure

**Plate forme:** Construction mécano-soudée résistante à la torsion, couronne d'orientation à billes à une rangée, à denture extérieure, permettant une rotation illimitée sur 360°. Graissage centralisé.

**Moteur:** Mercedes-Benz diesel 6 cylindres, modèle OM936LA, certifié pour EUROMOT IV ou EPA Tier 4f, refroidi par eau, soufflante à entraînement hydrostatique avec régulation électronique. Cylindrée 7,7 l, puissance 260 kW (354 CV) à 2200 min<sup>-1</sup>, couple 1400 Nm à 1200 min<sup>-1</sup> jusqu'à 1600 min<sup>-1</sup>, régime moteur lors du travail de grue limité à 1800 min<sup>-1</sup> au maximum. Capacité du réservoir de carburant: 280 l. Capacité du réservoir AdBlue: 40 l.

**Boîte de vitesses:** Boîte principale ZF-AS-Tronic, modèle mid 12 AS 1625 SO, boîte de vitesses mécanique avec embrayage à sec électro-pneumatique et commandes des vitesses complètement automatique avec 12 vitesses AV et 2 vitesses AR. Si nécessaire, mode partiellement automatique (Tip-Tronic) avec sélection de vitesses manuelle possible.

**Système hydraulique:** Système diesel-hydraulique à 2 circuits, radiateur d'huile, 1 pompe à piston axial avec moteur à cylindrée constante pour télescopage, mécanismes de relevage et de levage et 1 pompe à piston axial (réglable électro-hydrauliquement) pour groupe de rotation et 1 pompe à piston axial (réglable électro-hydrauliquement), connectable pour fonction de la somme de télescopage.

**Système de commande:** 2 manipulateurs à commande en croix (4 sens), assistés électriquement.

**Flèche télescopique:** Flèche télescopique à sept éléments, en acier à texture fine et très résistant, se composant d'une flèche de base et de 6 éléments télescopiques, 1 vérin de télescopage, télescopable hydrauliquement sous charge partielle. Longueur 9,5 m à 48,0 m. Tête de flèche avec 4 poulies.

**Mécanisme de relevage:** Un vérin différentiel pourvu d'un clapet ralentisseur d'arrêt de descente.

**Mécanisme de levage:** Moteur à cylindrée constante à piston axial, tambour de levage avec boîte planétaire incorporée et frein d'arrêt à disques multiples hydraulique à ressort, libéré lors du levage, indicateur de rotation du treuil de câble. Indicateur de rotation du treuil. Câble de levage avec dispositif "Super-Stop".

**Groupe de rotation:** Moteur à piston axial, engrenage planétaire à deux étages, avec frein de service actionné à pied avec dispositif d'arrêt.

**Contrepoids:** Standard 5,1 t divisible (programme CEC pour 0 t, 2,1 t, 4,2 t, 5 t (5,1 t)). Commande à partir de la cabine de grue.

**Cabine du grutier:** Cabine de grue spacieuse, construction en matière composite acier/plastique avec vitrage de sécurité en verre teinté, place de travail inclinable avec siège du conducteur réglable, amorti mécaniquement, chauffant ; chauffage à eau chaude autonome (avec préchauffage du moteur), climatiseur, radio / CD-player, éléments de commande et de contrôle pour le service de grue, actionnement des outriggers et possibilité de déplacement à partir de la superstructure.

**Système électrique:** 24 V courant continu, comprenant une dynamo triphasée de 100 A, 2 batteries, chacune de 12 V, 170 Ah, 2 gyrophares sur la plaque tournante à l'arrière gauche et droite, à côté du mécanisme de levage, 2 feux de position AR, 2 phares de travail intégrés dans la cabine de grue, 1 phare de travail sur la flèche de base, 2 feux latéraux sur la tête de la flèche.

**Dispositifs de sécurité:** Contrôleur électronique d'état de charge (CEC), limitation du rayon de rotation et du rayon de travail avec fonction 'Slow-Stop', interrupteur fin de course de levage, interrupteur fin de course de treuil, soupapes de sécurité contre les ruptures de tuyaux et flexibles.

**Équipement supplémentaire:** (avec supplément de prix) Rallonge de flèche 1 m + 6,4 m au choix inclinable 0°, 20° et 40°, fléchette pour levage lourde 0,4 m + 1,3 m, contrepoids supplémentaire 7,9 t, sélection de mouffes inférieures, 2<sup>ème</sup> treuil levage, peinture spéciale et inscription. Autres équipements supplémentaires sur demande.

## Chasis

**Bastidor:** Construcción de acero de alta resistencia soldado, resistente a la torsión y a la flexión. Sistema de engrase central.

**Estabilización:** Estabilizadores telescópicos hidráulicos de 4 puntos, incl. base de apoyo asimétrica y detección automática de longitud, posibilidad de manejo desde ambos lados del chasis portante y en la cabina de la grúa. Extensión de los estabilizadores: 6,4 m (5,4 m / 4,4 m / 2,4 m) x 7,2 m.

**Motor:** No hay motor del chasis independiente, accionamiento de traslación mediante motor en la superestructura.

**Transmisión:** Transmisión bloqueada con el motor, montada en la superestructura, accionamiento del chasis mediante engranaje angular y árboles cardán.

**Divisor de fuerza:** Accionamiento de la superestructura mediante árbol cardán a través del centro de giro de la grúa, con diferencial y bloqueo de diferencial.

**Tracción:** 6 x 6

**Ejes:**

- 1º eje: de dirección, accionado, con bloqueo diferencial transversal.
- 2º eje: de dirección, accionado, con bloqueo diferencial transversal.
- 3º eje: de dirección, accionado, con bloqueo diferencial transversal.

**Suspensión de los ejes:** Suspensión hidroneumática con regulación del nivel. Posibilidad de bloqueo electro-hidráulico de los cilindros de suspensión.

**Frenos:** Sistema de frenos de doble circuito de aire comprimido con sistema ABS y secador de aire. Freno de estacionamiento del tipo freno de muelle, accionando en los ejes 2 y 3, freno de motor como freno continuo.

**Neumáticos:** 6 ruedas de disco de chapa de acero 11.00-25/1.7; neumáticos 445/95 R25 174F (16.00 R 25).

**Dirección:** Dirección hidráulica de doble circuito del tipo ZF Servocom, mecánica, con asistencia hidráulica. Dirección con unión mecánica al 1º y 2º eje. En el modo de carretera el 3º eje está bloqueado en posición de línea recta. En el lugar de obras, el 3º eje puede ser desbloqueado y dirigirse, accionando un pulsador en la cabina del conductor. Es posible el traslado desde la superestructura.

**Cabina del chasis:** Cabina de conductor frontal para dos personas en construcción compuesta de acero y plástico, acristalamiento de seguridad, asientos con suspensión neumática (asiento del conductor calefactable) y calefacción por agua independiente del motor, climatizador, radio / reproductor de CD, elementos de control y mando para la conducción. Regulador de velocidad.

**Sistema eléctrico:** 24 voltios de corriente continua. Faros principales bihalógenos para luz de carretera y luz de cruce, luz LED de marcha diurna, 2 faros LED antiniebla, luces laterales, 2 luces traseras de siete cámaras con luz trasera antiniebla y faro de marcha atrás. Alarma acústica de marcha atrás. 2 luces de aviso omnidireccionales sobre la cabina del chasis. 4 faros para iluminación de la zona de apoyo, conmutable también desde la cabina del chasis. Cableado con componentes del bus CAN con sistema CSS (Sistema de Control y Servicio) de autodiagnóstico integrado.

**Equipamiento adicional:** (con suplemento de precio) Enganche para remolque, freno de corrientes parásitas en el 3º eje, caja de herramientas, indicador de la presión de apoyo, control de la presión de los neumáticos, neumáticos 385/95 R25 170F (14.00 R 25), 525/80 R25 176F (20.5 R 25). Pintura especial y rotulación. Otros equipamientos sobre pedido.

## Superestructura

**Bastidor:** Construcción en acero soldado resistente a la torsión con una unión de rodadura con bolas de una sola fila de bolas con dientes externos, con giro continuo de 360°. Sistema de engrase central.

**Motor:** Motor Mercedes-Benz de 6 cilindros diesel, modelo OM936LA, certificado para EUROMOT IV o EPA Tier 4f, refrigerado por agua, ventilador con propulsión hidrostática y regulación electrónica. Cilindrada 7,7 l, potencia 260 kW (354 CV) con 2.200 r.p.m., par de giro 1.400 Nm con 1.200 r.p.m. hasta 1.600 r.p.m., número de revoluciones del motor para trabajos con la grúa limitado a 1.800 r.p.m. máx. Depósito de combustible: 280 l. Depósito AdBlue: 40 l.

**Transmisión:** Transmisión principal mecánica del tipo ZF-AS-Tronic mid 12 AS 1625 SO con embrague en seco con accionamiento electro-neumático y cambio automático con 12 marchas delanteras y 2 marchas traseras. Si fuera necesario, se puede operar la transmisión en forma parcialmente automática (Tip-Tronic), seleccionando las marchas manualmente.

**Sistema hidráulico:** Sistema dieselhidráulico de 2 circuitos, radiador de aceite, 1 bomba de pistones axiales con motor constante para telescopiado, ajuste de pluma y mecanismo elevador y 1 bomba de pistones axiales (regulable electrohidráulicamente) para mecanismo giratorio y 1 bomba de pistones axiales (regulable electrohidráulicamente) conectable para la función de sumas de telescopiado.

**Controles:** Dos palancas de control en cruz cuádruples con mando eléctrico avanzado.

**Pluma telescópica:** Pluma telescópica de siete secciones de acero de alta resistencia soldado, se compone de un tramo base y 6 piezas telescópicas, 1 cilindro telescópico, telescópico hidráulicamente bajo carga parcial. 9,5 m – 48,0 m de largo. Cabeza de pluma con 4 poleas.

**Mecanismo de basculado:** 1 cilindro diferencial con válvula de retención de bajada de bloqueo integrada.

**Cabrestante principal:** Motor de cilindrada constante de pistones axiales, tambor de cabrestante con reducción planetaria incorporada y freno hidráulico a discos múltiples, cargado a resorte, con sistema libre de elevación, indicador de giros del cabrestante. Cable de elevación con sistema 'Super-Stop'.

**Sistema de giro:** Motor de pistones axiales, reducción planetaria de dos etapas con freno de servicio accionado por pedal con enclavamiento.

**Contrapeso:** Estándar 5,1 t divisible (programa LMC para 0 t, 2,1 t, 4,2 t, 5 t (5,1 t)). El contrapeso se acciona desde la cabina de la superestructura.

**Cabina de la grúa:** Cabina de grúa espaciosa en construcción de acero y plástico, con cristales tintados de seguridad, puesto de trabajo inclinable con asiento de conductor regulable, amortiguado mecánicamente, con calefacción, calefacción independiente del motor con precalefacción del motor, climatizador, radio / reproductor de CD, elementos de control y de mando para el manejo de la grúa. El sistema de estabilización y las funciones del motor del chasis pueden activarse desde la cabina de la superestructura.

**Sistema eléctrico:** 24 voltios de corriente continua con generador de corriente trifásica de 100 amperios, 2 baterías de 12 voltios y 170 Ah cada una, 2 luces de aviso omnidireccionales atrás a la izquierda y derecha en la mesa giratoria al lado del mecanismo elevador, 2 luces de posición traseras, 2 faros de trabajo integrados en la cabina de la superestructura, 1 faro de trabajo en la pluma base, 2 luces laterales en el cabezal de la pluma.

**Dispositivos de seguridad:** Limitador electrónico del momento de carga (LMC), limitación de la zona de giro y del área de trabajo con función "Slow-Stop", interruptor final de carrera de elevación, interruptor fin de carrera del cabrestante, válvulas de seguridad contra roturas de tubos y latiguillos.

**Equipamiento adicional:** (con suplemento de precio) Plumín de 1 m + 6,4 m, regulable opcionalmente de 0°, 20° y 40°, plumín de carga pesada de 0,4 m + 1,3 m, contrapeso adicional 7,9 t, selección de motones inferiores, 2º mecanismo elevador, pintura especial y rotulación. Otros equipamientos adicionales sobre pedido.

## Equipaggiamento

### Carro

**Intelaiatura:** Struttura saldata resistente a sollecitazioni a torsione e flessione in acciaio a grano fine ad alta resistenza. Impianto di lubrificazione centrale.

**Stabilizzazione:** Stabilizzazione telescopica su 4 punti, di tipo idraulico, incl. base di appoggio asimmetrica, rilevamento automatico lunghezza, possibilità di comando dai due lati del telaio e dalla cabina della sovrastruttura.  
Base di appoggio 6,4 m (5,4 m / 4,4 m / 2,4 m) x 7,2 m.

**Motore:** Non è presente alcun motore del carro separato, trazione tramite motore della sovrastruttura.

**Cambio:** Cambio montato in blocco con motore installato nella sovrastruttura, collegato tramite rinvii angolari e alberi cardanici al carro.

**Gruppo di rinvio:** Trasmissione tramite albero cardanico dalla sovrastruttura tramite il centro ralla della gru con differenziale e bloccaggio differenziale.

**Trasmissione:** 6 x 6

#### Asi:

1° asse: snodato, asse motore, bloccaggio differenziale trasversale.

2° asse: snodato, asse motore, bloccaggio differenziale trasversale.

3° asse: snodato, asse motore, bloccaggio differenziale trasversale.

**Sospensione assiale:** Sospensione idro-pneumatica con regolazione di livello. Cilindro di sospensione con bloccaggio elettroidraulico.

**Freni:** Impianto frenante ad aria compressa a doppio circuito con sistema ABS ed essiccatore di aria. Freno di stazionamento con funzione di freno a molla a rilascio pneumatico sul 2° e 3° asse, freno motore come freno continuo.

**Ruote:** 6 ruote con disco in lamiera d'acciaio 11.00-25/1.7; Pneumatici 445/95 R25 174F (16.00 R 25).

**Sterzo:** Sistema idroguida a doppio circuito ZF Servocom con supporto meccanico e idraulico. Snodo con collegamento meccanico 1° e 2° asse. In modalità su strada il 3° asse è serrato in posizione rettilinea. In cantiere il 3° asse può essere sbloccato e guidato mediante un tasto nella cabina del conducente. È possibile muovere la sovrastruttura.

**Cabina del carro:** Cabina conducente frontale per due, in struttura composita acciaio-plastica, vetratura di sicurezza, sedili molleggiati (sedile conducente con riscaldamento) e riscaldamento acqua indipendente dal motore, climatizzatore, radio/lettore CD, elementi di controllo e comando per la marcia. Funzione Tempomat.

**Impianto elettrico:** Impianto a corrente continua 24 Volt. Faro di lavoro principale bi-alogeno per anabbaglianti e abbaglianti, luce diurna LED, 2 fendinebbia LED, luci laterali, 2 fari a sette luci posteriori con fendinebbia di coda e proiettore di retromarcia. Segnale acustico di retromarcia. 2 lampeggianti sulla cabina del carro. 4 fari per illuminazione della zona di stabilizzazione, attivabili anche dalla cabina del carro. Cablaggio con componenti sistema CAN Bus, sistema CSS (Control & Service System) di diagnosi autonoma integrato.

**Equipaggiamento aggiuntivo:** (a sovrapprezzo)

Gancio di traino, freno a correnti parassite sul 3° asse, cassetta attrezzi, indicatore della pressione di stabilizzazione, controllo della pressione pneumatici, pneumatici 385/95 R25 170F (14.00 R 25), 525/80 R25 176F (20.5 R 25). Verniciatura speciale e diciture. Ulteriore equipaggiamento aggiuntivo su richiesta.

### Sovrastruttura

**Intelaiatura:** Struttura saldata resistente alla torsione con corona di rotazione a sfere ad una fila, dentata esternamente, ruotabile di 360° senza limitazioni. Impianto di lubrificazione centrale.

**Motore:** Motore diesel Mercedes-Benz a 6 cilindri OM936LA, certificato per EUROMOT IV o EPA Tier 4f, raffreddato ad acqua, ventilatore ad azionamento idrostatico con regolazione elettronica. Cilindrata 7,7 l, potenza 260 kW (354 PS) a 2200 min<sup>-1</sup>, coppia 1400 Nm a 1200 min<sup>-1</sup> fino a 1600 min<sup>-1</sup>, numero di giri motore durante le operazioni con la gru limitato a max. 1800 min<sup>-1</sup>. Serbatoio carburante: 280 l. Serbatoio AdBlue: 40 l.

**Cambio:** Trasmissione principale cambio meccanico ZF-AS-Tronic mid 12 AS 1625 SO con frizione a secco ad azionamento elettro-pneumatico e innesto marce automatico, con 12 marce avanti e 2 retromarce. Opzionale: funzionamento parzialmente automatico (Tiptronic) con selezione marce manuale.

**Impianto idraulico:** Diesel-idraulico con idraulica a 2 circuiti, radiatore olio, 1 pompa a pistoni assiali con motore costante per telescopaggio, brandeggio e meccanismo di sollevamento e 1 pompa a pistoni assiali (regolazione elettroidraulica) per gruppo di rotazione e 1 pompa a pistoni assiali (regolazione elettroidraulica) regolabile per telescopaggio circuito a somma di portate.

**Comando:** Due leve di comando gru x4 con precomando elettrico.

**Braccio telescopico:** Braccio telescopico in sette sezioni in acciaio a grano fine ad alta resistenza, composto da un braccio base e 6 sezioni telescopiche, 1 cilindro telescopico, funzione telescopica ad azionamento idraulico sotto carico parziale. Lunghezza 9,5 m - 48,0 m. Testa rullo con 4 pulegge.

**Gruppo di brandeggio:** Un cilindro differenziale con valvola di frenata caduta verticale montata.

**Meccanismo di sollevamento:** Motore costante a pistone assiale, tamburo del meccanismo di sollevamento con rotismo epicicloidale incorporato e freno a disco idraulico sollecitato a molla con ruota libera integrata nel sollevamento, indicatore delle rotazioni dei verricelli. Fune di sollevamento con dispositivo "Super-Stop".

**Gruppo di rotazione:** Motore a pistone assiale, ingranaggio epicicloidale a due stadi con freno di servizio azionato a pedale e stazionamento.

**Contrappeso:** Standard 5,1 t suddivisibili (programma LMC per 0 t, 2,1 t, 4,2 t, 5 t (5,1 t)). L'azionamento si effettua dalla cabina.

**Cabina della sovrastruttura:** Spaziosa cabina della gru in acciaio-plastica, con vetratura di sicurezza e cristalli oscurati, postazione di lavoro ribaltabile con sedile conducente regolabile, con molleggio meccanico e riscaldamento, riscaldamento indipendente dal motore con preriscaldamento motore, climatizzatore, radio/lettore CD, elementi di controllo e comando per esercizio gru, azionamento stabilizzazione e guida dalla sovrastruttura.

**Impianto elettrico:** Impianto a corrente continua 24 Volt con alternatore da 100 Ampere, 2 batterie da 12 Volt 170 Ah ciascuna, 2 lampeggianti posteriori a destra e a sinistra sulla superficie rotante accanto al meccanismo di sollevamento, 2 luci di posizione posteriori, 2 proiettori di lavoro integrati nella cabina della sovrastruttura, 1 proiettore di lavoro sul braccio base, 2 luci laterali sulla testa del braccio.

**Dispositivi di sicurezza:** Limitatore del momento di carico (LMC) elettronico con delimitazione dell'area di rotazione e delimitazione dell'area di lavoro con funzione Slow-Stop, interruttore di fine corsa, fine corsa argani, valvole di sicurezza contro rottura tubi e tubi flessibili.

**Equipaggiamento aggiuntivo:** (a sovrapprezzo)

Prolunga del braccio 1 m + 6,4 m a scelta con regolazione angolo 0°, 20° e 40°, falcone per carichi pesanti 0,4 m + 1,3 m, contrappeso aggiuntivo 7,9 t, diversi bozzelli, 2 meccanismo di sollevamento, verniciatura speciale e diciture. Altro equipaggiamento aggiuntivo su richiesta.

## Ходовая платформа

**Рама:** Жесткая на скручивание и изгиб сварная конструкция из высокопрочной мелкозернистой стали. Централизованная смазочная система.

**Опоры:** Гидравлическая опора в четырех точках с телескопическим выдвиганием, включая поддержку асимметричной базы аутригеров и автоматическое распознавание положения стрелы, возможность управления с обеих сторон ходовой части и из кабины на поворотной платформе.

Опорная база 6,4 м (5,4 м / 4,4 м / 2,4 м) x 7,2 м.

**Двигатель:** Без отдельного двигателя ходовой платформы, функция хода с приводом от двигателя на поворотной платформе.

**Коробка передач:** Коробка передач в едином агрегате с двигателем встроена в поворотную платформу, усилие на ходовую платформу передается посредством угловой конической передачи и карданных валов.

**Раздаточная коробка:** Привод через карданный вал от поворотной платформы через ось вращения крана, с дифференциалом и блокировкой дифференциала.

**Привод:** 6 x 6

**Оси:**

1-я ось: управляемая, приводная, с поперечной блокировкой межколёсного дифференциала.

2-я ось: управляемая, приводная, с поперечной блокировкой межколёсного дифференциала.

3-я ось: управляемая, приводная, с поперечной блокировкой межколёсного дифференциала.

**Подвеска оси:** Гидропневматическая подвеска с регулировкой уровня. Цилиндр подвески с возможностью блокировки электрогидравлическим способом.

**Тормоза:** Пневматическая двухмагистральная тормозная система с системой ABS и осушителем воздуха. Стояночный тормоз, представляющий собой тормозной механизм с пружинным энергоаккумулятором, воздействует на 2-ю и 3-ю оси; моторный тормоз в качестве постоянного тормоза.

**Колеса:** 6 дисковых колес из листовой стали 11.00-25/1.7; шины 445/95 R25 174F (16.00 R 25).

**Рулевое управление:** Двухконтурное гидравлическое рулевое управление ZF-Servocom, механическое, с гидравлическим сервоусилителем. Управление 1-й и 2-й осями осуществляется через механическое соединение ось. В дорожном режиме 3-ья ось блокируется в прямом положении. На стройплощадке 3-я ось может быть разблокирована и управляется кнопкой из кабины водителя. Возможно управление движением автокрана с поворотной платформы.

**Кабина ходовой платформы:** Двухместная передняя кабина водителя композитной конструкции (металлический лист и стекловолокно), безосколочное стекло, сиденье с пневматической подвеской (сиденье водителя с подогревом), независимое от двигателя водяное отопление, кондиционер, радиоприемник / CD-плеер, элементы управления и индикации для ходового режима. Функция темпомата.

**Система электрооборудования:** Система постоянного тока напряжением 24 В. Бигалогеновые основные фары для ближнего и дальнего света, светодиодные дневные ходовые огни, 2 светодиодных противотуманных фары, боковые фонари, подфарники, 2 светодиодных габаритных фонаря сзади с задней противотуманной фарой и фарой заднего хода. Звуковой сигнал заднего хода. 2 проблесковых маячка на кабине ходовой платформы. 4 фары для подсветки аутригеров, включаемые также из кабины ходовой платформы. Разводка компонентов шины CAN, встроенная самодиагностика CSS (Control & Service System).

**Дополнительное оборудование:** (за доплату) Тягово-сцепное устройство, электродинамический тормоз-замедлитель на 3-й оси, ящик для инструментов, индикатор давления опор, мониторинг давления в шинах, шины 385/95 R25 170F (14.00 R 25), 525/80 R25 176F (20.5 R 25). Специальное лаковое покрытие и нанесение надписей. Другое дополнительное оборудование — по запросу.

## Оборудование

### Поворотная платформа

**Рама:** Жёсткая на скручивание сварная конструкция с однорядным сферическим поворотным соединением с внешними зубьями, с неограниченным поворотом на 360°. Централизованная смазочная система.

**Двигатель:** 6-цилиндровый дизельный двигатель Mercedes-Benz OM936LA, сертифицирован по нормам EUROMOT IV или EPA Tier 4f, с водяным охлаждением, вентилятор с гидростатическим приводом и электронным регулированием. Рабочий объем двигателя 7,7 л, мощность 260 кВт (354 л.с.) при 2200 мин<sup>-1</sup>, крутящий момент 1400 Н·м при скорости вращения от 1200 мин<sup>-1</sup> до 1600 мин<sup>-1</sup>, число оборотов двигателя при проведении крановых работ не более 1800 мин<sup>-1</sup>. Топливный бак: 280 л. Бак для присадки AdBlue: 40 л.

**Коробка передач:** Главный редуктор ZF-AS-Tronic mid 12 AS 1625 SO со электронно-пневматическим управлением сухим дисковым сцеплением и полностью автоматическим переключением 12 передач переднего и 2 передач заднего хода. При необходимости возможен полуавтоматический режим (Tip-Tronic) с переключением передач вручную.

**Гидравлическая система:** Дизельно-гидравлическая с 2-контурным гидроагрегатом, масляный радиатор, 1 аксиально-поршневой насос с нерегулируемым мотором для телескопирования, изменения вылета и подъемного механизма, 1 аксиально-поршневой насос (с электрогидравлической регулировкой) для поворотного механизма и 1 подключаемый аксиально-поршневой насос (с электрогидравлической регулировкой) для добавления функции телескопирования.

**Система управления:** Два 4-сторонних крестовых рычага управления краном с предварительным электрическим регулированием.

**Телескопическая стрела:** Семисекционная телескопическая стрела из высокопрочной мелкозернистой стали, включает основную секцию и 6 телескопических секций, 1 телескопический цилиндр, выдвигается гидравлическим способом по мере создания нагрузки. Длина 9,5 м – 48,0 м. Роликовая обойма с 4 канатными блоками.

**Механизм изменения подъёма стрелы:** Дифференциальный цилиндр со смонтированным на нем клапаном спускного тормоза.

**Подъемный механизм:** Аксиально-поршневой двигатель с постоянным рабочим объемом, барабан подъемного механизма с встроенной планетарной коробкой передач и пружинным гидравлическим многодисковым тормозом с встроенным механизмом свободного хода при подъеме, сигнализатор вращения барабана лебедки. Подъемный трос с тормозным приспособлением «Super-Stop».

**Поворотный механизм:** Аксиально-поршневой двигатель с постоянным рабочим объемом, двухступенчатая планетарная коробка передач с ножным рабочим тормозом и механизм блокировки.

**Противовес:** Стандартный 5,1 т, составной (программа ограничителя момента нагрузки для 0 т, 2,1 т, 4,2 т, 5 т (5,1 т)). Управление осуществляется из кабины на поворотной платформе.

**Кабина на поворотной платформе:** Просторная кабина крана композитной конструкции (металл и пластик), остекление тонированным безосколочным стеклом, откидное рабочее место с регулируемым по высоте сиденьем водителя с механическим амортизатором и подогревом, независимый от работы двигателя отопитель с подогревом двигателя, кондиционер, радио/CD-плеер, элементы управления и индикации для режима работы крана, выдвигания аутригеров и перемещения крана по рабочей площадке на поворотной платформе.

**Система электрооборудования:** 24-вольтовая система постоянного тока с генератором трехфазного тока на 100 ампер, 2 аккумуляторные батареи по 12 В емкостью 170 Ач, 2 проблесковых маячка сзади слева и справа на поворотной платформе рядом с подъемным механизмом, 2 стояночных фонаря сзади, 2 рабочих прожектора, интегрированных в кабину поворотной платформы, 1 рабочий прожектор на основной секции стрелы, 2 боковых фонаря на головной части стрелы.

**Устройства безопасности:** Электронный ограничитель момента нагрузки (LMB), ограничитель зоны поворота и рабочей зоны с функцией медленной остановки «Slow-Stop», концевой подъемный выключатель, концевой выключатель лебедки, клапаны безопасности на случай повреждения трубок и шлангов.

**Дополнительное оборудование:** (за надбавку к цене) удлинение стрелы 1 м + 6,4 м, по выбору регулятор угла поворота 0°, 20° и 40°, гусек для тяжелых грузов 0,4 м + 1,3 м, дополнительный противовес 7,9 т, различные крюковые обоймы, 2-й подъемный механизм, специальное лаковое покрытие и нанесение надписей. Другое дополнительное оборудование – по запросу.

# ADDITIONAL INFORMATION

ZUSATZINFORMATIONEN  
INFORMATIONS SUPPLÉMENTAIRES  
INFORMACIÓN ADICIONAL  
ALTRE INFORMAZIONI  
ДОПОЛНИТЕЛЬНАЯ ИНФОРМАЦИЯ



## Additional information · Zusatzinformationen · Informations supplémentaires

### Remarks relating to the capacity charts · Anmerkungen zu den Traglasttabellen Remarques relatives aux tableaux des charges

1. The lifting capacities in the structural area are based on EN 13000.
2. The lifting capacities in the stability area are based on ISO 4305 / EN 13000.
3. Depending on the boom length, max. wind speeds between 7 m/s and 15 m/s are permissible in the lifting capacity charts.
4. Due to different extending sequences of the telescopes, the boom lengths indicated in the lifting capacity charts may deviate slightly.
5. The lifting capacities are shown in metric tons.
6. The weight of load handling devices such as hook blocks, slings, etc., must be considered as part of the load and must be deducted from the lifting capacities.
7. The lifting capacities for the telescopic boom apply to a crane with no jib being stowed or mounted on the crane.
8. The load radius is the horizontal distance from the centre of the slewing ring to the centre of gravity of a suspended, non-oscillating load.

1. Die Tragfähigkeiten im Festigkeitsbereich basieren auf EN 13000.
2. Die Tragfähigkeiten im Standsicherheitsbereich entsprechen ISO 4305 / EN 13000.
3. In Abhängigkeit der Auslegerlänge sind bei den Traglasttabellen max. Windgeschwindigkeiten zwischen 7 m/s und 15 m/s zulässig.
4. Aufgrund unterschiedlicher Ausfahrfolgen der Teleskope können die in den Traglasttabellen angegebenen Auslegerlängen geringfügig abweichend sein.
5. Die Tragfähigkeiten sind in metrischen Tonnen angegeben.
6. Das Gewicht des Lasthakens bzw. der Unterflasche und weiterer Anschlagmittel ist von der Tragfähigkeit abzuziehen.
7. Die Tragfähigkeiten für den Teleskopausleger gelten nur bei demontierter Auslegerverlängerung.
8. Die Ausladung ist der horizontale Abstand von Mitte Drehkranz bis zum Schwerpunkt freihängender, nicht schwingender Last.

1. Les forces de levage sont conformes aux normes EN 13000.
2. Les forces de levage dans la partie de stabilité au renversement sont conformes aux normes ISO 4305 / EN 13000.
3. Des vitesses de vent max. entre 7 et 15 m/s sont autorisées pour les tableaux des charges en fonction de la longueur de la flèche.
4. Les longueurs de flèche indiquées dans les tableaux des charges peuvent être légèrement divergentes en raison des différentes séries de déploiement des télescopes.
5. Les forces de levage sont données en tonnes métriques.
6. Le poids du crochet-moufle et de tous les accessoires d'élingage font partie de la charge et sont à déduire des charges indiquées.
7. Les forces de levage indiquées pour la flèche télescopique s'entendent rallonge de flèche déposée.
8. La portée est la distance horizontale du milieu de la couronne d'orientation au centre de gravité de la charge suspendue librement sans osciller.

### General remarks · Allgemeine Anmerkungen · Remarques générales

Unless otherwise specified, all the information given in this brochure refers to the standard equipment of the crane and only is intended as general information. For correct crane operation, the original operating manual and lifting capacity charts are essential. No liability is accepted for the accuracy of this information. Errors and omissions excepted. Illustrations are similar only. All dimensions - unless otherwise specified - in mm.

Alle Angaben in dieser Broschüre beziehen sich - wenn nicht anderweitig aufgeführt - auf die Standard-Ausstattung des Krans und dienen nur zur allgemeinen Information. Zum ordnungsgemäßen Betrieb des Krans sind die original Bedienungsanleitung und Traglasttabellen maßgeblich. Alle Angaben erfolgen ohne Gewähr. Änderungen und Irrtümer vorbehalten. Abbildungen ähnlich. Alle Bemaßungen - wenn nicht anders angegeben - in mm.

Sauf indication contraire, toutes les informations dans cette brochure se rapportent à l'équipement standard de la grue et constituent uniquement des informations générales. Pour le fonctionnement correct de la grue, le manuel d'instructions original et les tableaux des charges de levage sont déterminants. Toutes les informations sont fournies sans garantie. Sous réserve de modifications techniques et d'erreurs. Illustrations similaires mais pas identiques à l'engin montré. Toutes les cotes - sauf indication différente - en mm.



### Notas relativas a los graficos de carga · Annotazioni sulle tabelle delle portate Примечания к таблицам грузоподъемности

1. En cuanto a los datos referentes a resistencia, las capacidades de carga están basados sobre las normas EN 13000.
2. En cuanto a los datos referentes a estabilidad anti-vuelco, las capacidades de carga están basados sobre las normas ISO 4305 / EN 13000.
3. En función de la longitud de la pluma, son admisibles velocidades máx. del viento entre 7 m/s y 15 m/s en las tablas de cargas.
4. Debido a las diferentes secuencias de extensión de los telescopios, es posible que las longitudes de la pluma indicadas en las tablas de cargas sean ligeramente distintas.
5. Las capacidades de carga indicadas en las tablas corresponden a toneladas métricas.
6. Hay que deducir los pesos del gancho, eslingas y de otros dispositivos para fijación de cargas de los valores indicados en las tablas.
7. Las capacidades de carga referentes a la pluma telescópica valen solamente si el alargamiento de pluma está desmontado.
8. El alcance de pluma es la distancia horizontal del centro de la corona de giro al centro de gravedad de una carga suspendida que no está oscilando.

1. Le capacità di carico nel range di resistenza sono riferite alla norma EN 13000.
2. Le capacità di carico nel range di stabilità sono conformi alle norme ISO 4305 / EN 13000.
3. Nelle tabelle delle portate sono ammesse velocità del vento comprese tra 7 m/s e 15 m/s in funzione della lunghezza del braccio.
4. Considerata le diverse sequenze di sfilo dei telescopi, le lunghezze del braccio indicate nelle tabelle delle portate possono essere lievemente differenti.
5. Le capacità di carico sono indicate in tonnellate metriche.
6. Il peso del gancio di carico, ovvero del bozzello e delle altre imbracature deve essere detratto dalla capacità di carico.
7. Le capacità di carico per il braccio telescopico sono applicabili soltanto con prolunga del braccio smontata.
8. Per sbraccio si intende la distanza orizzontale dal centro della corona rotante al centro del carico sospeso, ma non oscillante.

1. Значения грузоподъемности в пределах категории прочности основаны на положениях стандарта EN 13000.
2. Значения грузоподъемности в пределах области устойчивости соответствуют стандарту ISO 4305 / EN 13000.
3. В зависимости от длины стрелы таблицы грузоподъемности допускают скорость ветра от 7 до 15 м/с.
4. Длина телескопической стрелы в выдвинутом состоянии может незначительно отличаться от указанной в таблицах грузоподъемности из-за различных последовательностей выдвигания.
5. Грузоподъемность указана в метрических тоннах.
6. Из грузоподъемности необходимо вычесть вес грузового крюка или крюковой обоймы, а также других грузозахватных приспособлений.
7. Значения грузоподъемности для телескопической стрелы действительны только при демонтированном удлинителе стрелы (гуське).
8. Вылет — это расстояние по горизонтали между центром поворотного круга и центром тяжести свободно подвешенного некачающегося груза.

### Notas adicionales · Annotazioni generali · Общие примечания











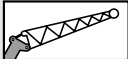





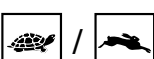







*A no ser que se indique lo contrario, todos los datos incluidos en este folleto hacen referencia al equipamiento estándar de la grúa y sólo tienen un carácter informativo general. El manual de instrucciones original y las tablas de capacidades de carga son determinantes para lograr un correcto funcionamiento de la grúa. Todos los datos se facilitan sin garantía. Reservadas las modificaciones y los errores. Ilustraciones similares. Todas las dimensiones - salvo indicación en contrario - en mm.*

*Se non diversamente specificato, tutti i dati di questa brochure si riferiscono alla dotazione standard della gru e sono da considerarsi come informazioni generali. Per un esercizio corretto della gru, sono determinanti il manuale d'uso originale e le tabelle delle portate. Si declina ogni responsabilità per tutti i dati. Con riserva di modifiche ed errori. Figure simili. Tutte le quotature sono in mm (se non diversamente specificato).*

*Все данные, приведенные в этой брошюре, относятся – если не указано иное – к стандартному оснащению крана и служат лишь для общей информации. Порядок надлежащей эксплуатации крана определяется оригиналом руководства по эксплуатации и таблицами грузоподъемности. Все данные приведены без обязательств. Возможны изменения и ошибки. Иллюстрации являются приблизительными. Все размеры – если не указано другое – в мм.*

# Symbols · Symbolerklärung · Glossaire des symboles

## Glosario de simbolos · Spiegazione dei simboli · Условные обозначения

	Gross weight · Gesamtgewicht Poids total · Peso total Peso totale · Полная масса		Tiltable jib · abwinkelbare Spitze Flèche inclinable · Plumín regulable Punta con regolazione angolo Гусек с изменением угла наклона
	Axle load · Achslast Charge à l'essieu · Carga por eje Carico assiale · Осьевая нагрузка		Fly jib section · Spitzenteil Élément de flèche · Plumín Parte punta · Головная секция
	Drive · Antrieb Entraînement · Tracción Trazione · Привод		Swing area · Drehbereich Rayon de rotation · Zona de giro Area di rotazione · Область поворота
	Tyres · Bereifung Pneus · Neumáticos Pneumatici · Шины		Superstructure lock · Oberwagenverriegelung Verrouillage de la superstructure · Bloqueo de la superestructura · Bloccaggio sovrastruttura Блокировка поворотной платформы
	Gradeability · Steigfähigkeit · Capacité de gravissement de pente · Superación de pendientes · Capacità di salita Способность преодолевать подъем		Hydraulically lockable · Hydraulisch verriegelbar Verrouillable hydrauliquement · Con embulonamiento hidráulico · Con dispositivo di bloccaggio idraulico Гидравлическая блокировка
	Off road / On road · Gelände / Straße Tout-terrain / Mode "Route" · Todo terreno / En carretera Fuori strada / Su strada · Бездорожье / Дорога		Main winch · Hubwinde · Mécanisme de levage Cabrestante principal · Meccanismo di sollevamento Главная лебедка
	Speed · Geschwindigkeit Vitesse · Velocidad Velocità · Скорость		Auxiliary winch · Zusatzhubwinde Treuil supplémentaire · Cabrestante auxiliar Argano aggiuntivo · Дополнительная лебедка
	Outriggers · Abstützung Calage · Estabilizadores Stabilizzazione · На аутригерах		Type · Typ Tipo · Тип
	On tyres · Auf Rädern Sur pneus · Sobre neumáticos Su ruote · на колесах		Lifting capacity · Traglast Charge de levage · Carga Portata · Грузоподъемность
	Counterweight · Gegengewicht Contrepoids · Contrapeso Contrappeso · Противовес		Rope sheaves · Seilrollen Poulies de câbles · Poleas de cable Pulegge · Канатные шкивы
	Counterweight element · Gegengewichtselement Élément de contrepoids · Parte del contrapeso Parte contrappeso · Деталь противовеса		Parts of line · Seilstränge Brins de câble · Ramales de cable Spire della fune · Запасовка
	Length · Länge Longueur · Longitud Lunghezza · Длина		Dead-weight · Eigengewicht Poids total · Tara Peso proprio · Собственный вес
	Boom elevation · Wippwerk · Mécanisme de relevage Elevación de pluma · Gruppo di brandeggio Механизм изменения подъема стрелы		Wire rope length · Hubseillänge Longueur du câble de levage · Longitud del cable de izaje · Lunghezza fune di sollevamento Длина подъемного троса
	Boom telescoping · Teleskopieren Télescopage de flèche · Telescopaje de pluma Telescopaggio · Телескопирование		Wire rope diameter · Hubseildurchmesser Diamètre du câble de levage · Diámetro del cable de elevación · Diametro fune di sollevamento Диаметр подъемного троса
	Telescopic boom · Teleskopausleger Flèche télescopique · Pluma telescópica Braccio telescopico · Телескопическая стрела		Wire rope pulling force · Hubseilzugkraft Force de traction du câble de levage · Fuerza de tracción del cable de elevación · Forza di trazione fune di sollevamento · Тяговое усилие подъемного троса
	Radius · Ausladung Portée · Radio Sbraccio · Вылет		Weight · Gewicht Poids · Peso Peso · Вес

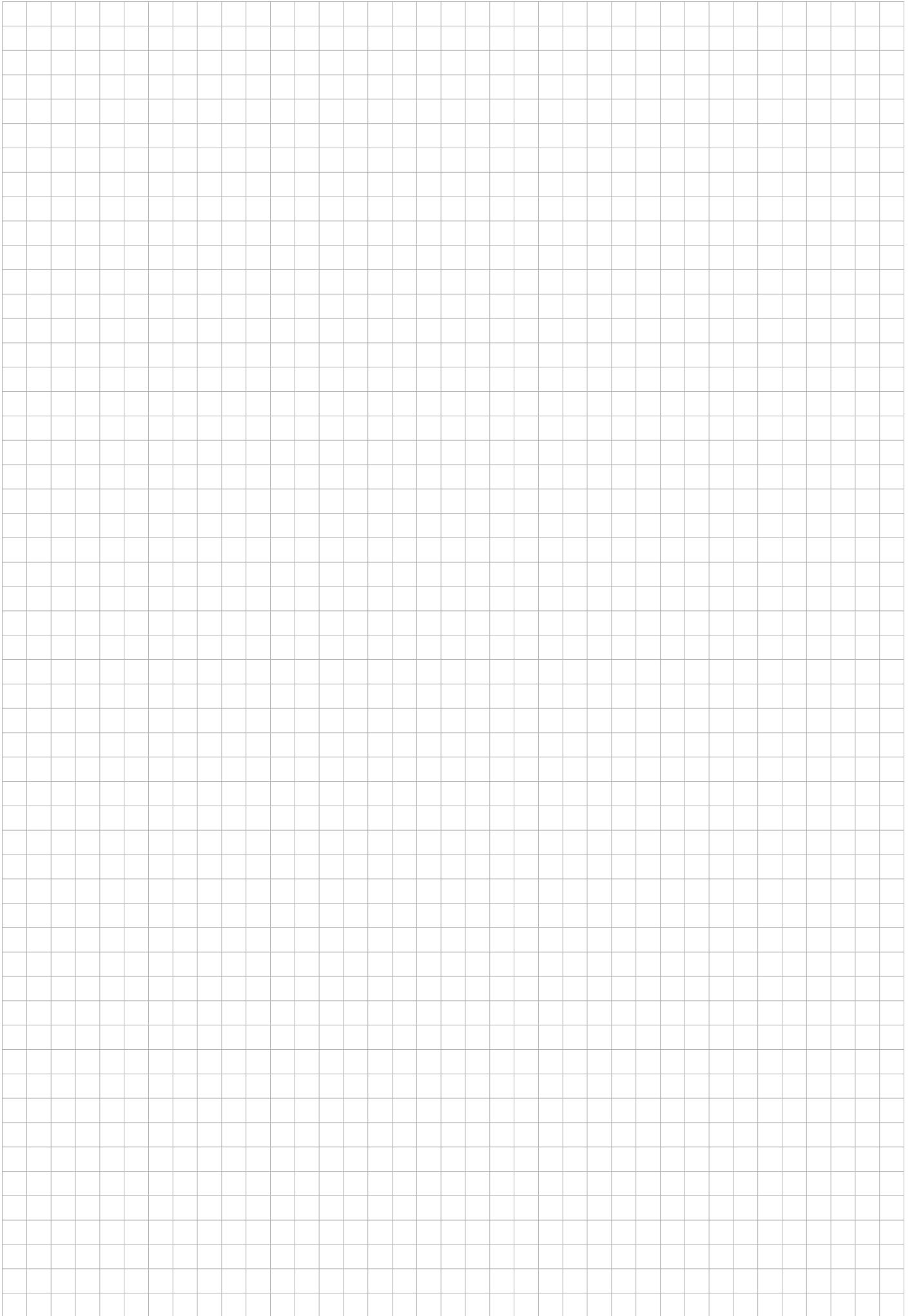



You can find your **direct TADANO contact person** on:  
[www.tadano.com/wwnetwork/](http://www.tadano.com/wwnetwork/)



**TADANO FAUN GmbH**

Faunberg 2 · 91207 Lauf a. d. Pegnitz · Germany  
Phone: +49-9123-185-0 · Fax: +49-9123-3085  
[www.tadanofaun.de](http://www.tadanofaun.de) · [info@tadanofaun.de](mailto:info@tadanofaun.de)

**TADANO LTD.** (International Division)

4-12, Kamezawa 2-chome, Sumida-ku Tokyo 130-0014, Japan  
Phone: 81-3-3621-7750 · Fax: 81-3-3621-7785  
[www.tadano.com](http://www.tadano.com) · [info@tadano.com](mailto:info@tadano.com)