

ATF-120-5.1

120 TON MAX. LIFTING CAPACITY

EUROMOT 5

ALL TERRAIN CRANE



PRELIMINARY

Table of contents · Inhaltsverzeichnis · Table des matières Índice · Sommario · Оглавление

General · Allgemein · Généralités · Generalidades · Generalità · Общие положения

Boom systems · Auslegersysteme · Systèmes de flèche · Sistema de pluma · Sistemi di bracci · Конфигурации стрелы 4 - 5

Vehicle dimensions · Fahrzeugabmessungen · Dimensions du véhicule · Dimensiones del vehículo
Dimensioni veicolo · Габариты машины 6

On-road and off-road driving · Straßen- und Geländefahrt · Marche route et tout terrain Traslado por carretera y todoterreno · Marcia su strada e fuori strada · Движение по дорогам и бездорожью

Axle loads · Achslasten · Charges par essieu · Cargas por eje · Carichi assiali · Нагрузка на ось 8

Speeds and gradeability · Geschwindigkeiten und Steigfähigkeit · Vitesses de conduite et gravissement de pente
Velocidades y pendientes superables · Velocità e pendenza · Скорость и грузоподъемность 8

Steering · Lenkung · Direction · Dirección · Sterzo · Рулевое управление 8

Transport · Transporte · Trasporto · Транспортировка

Counterweight · Gegengewicht · Contrepoids · Contrapeso · Contrappeso · Противовес 10 - 11

Jibs · Spitzen · Fléchettes · Plumines · Punte · гусек 12 - 13

Hose drum for hydraulic jib · Schlauchtrommel für hydraulische Spitze · Tambour de flexible pour fléchette hydraulique
Devanadera para plumín hidráulico · Aspo raccoglitorbo per punta idraulica · Барабан для намотки шланга для гидравлического гуська 14

Auxiliary winch · Zusatzhubwinde · Treuil supplémentaire · Cabrestante auxiliar
Argano aggiuntivo · Дополнительная лебедка 14

Operation · Einsatz · Utilisation · Uso · Эксплуатация

Main boom · Hauptausleger · Flèche principale · Pluma principal · Braccio principale · Главная стрела 16

Swing mechanism · Drehwerk · Groupe de rotation · Mecanismo de giro · Gruppo di rotazione · Поворотный механизм 16

Winches · Hubwinden · Treuils · Cabrestantes · Argani · Лебедки 16

Hook blocks · Unterflaschen · Mouflas · Pastecas de carga · Bozzelli · Крюковые обоймы 16

Working ranges and lifting capacities · Arbeitsbereiche und Traglasten · Rayons de travail et charges de levage
Áreas de trabajo y cargas · Aree di lavoro e portate · Рабочие зоны и грузоподъемность 18 - 45

Equipment · Ausstattung · Équipement · Equipamiento · Equipaggiamento · Оборудование

Equipment · Ausstattung · Équipement · Equipamiento · Equipaggiamento · Оборудование 47 - 54

Additional information · Zusatzinformationen · Informations supplémentaires Información adicional · Altre informazioni · Дополнительная информация

Remarks · Anmerkungen · Remarques · Notas · Annotazioni · Примечания 56 - 57

Symbols · Symbolerklärung · Glossaire des symboles · Glosario de simbolos
Spiegazione dei simboli · Условные обозначения 58

GENERAL TECHNICAL DATA

ALLGEMEINE TECHNISCHE DATEN

CARACTÉRISTIQUES TECHNIQUES GÉNÉRALES

DATOS TÉCNICOS GENERALES

DATI TECNICI GENERALI

ОБЩИЕ ТЕХНИЧЕСКИЕ ХАРАКТЕРИСТИКИ



General · Allgemein · Généralités
 Generalidades · Generalità · Общие положения

Boom systems · Auslegersysteme · Systèmes de flèche
 Sistema de pluma · Sistemi di bracci · Конфигурации стрелы

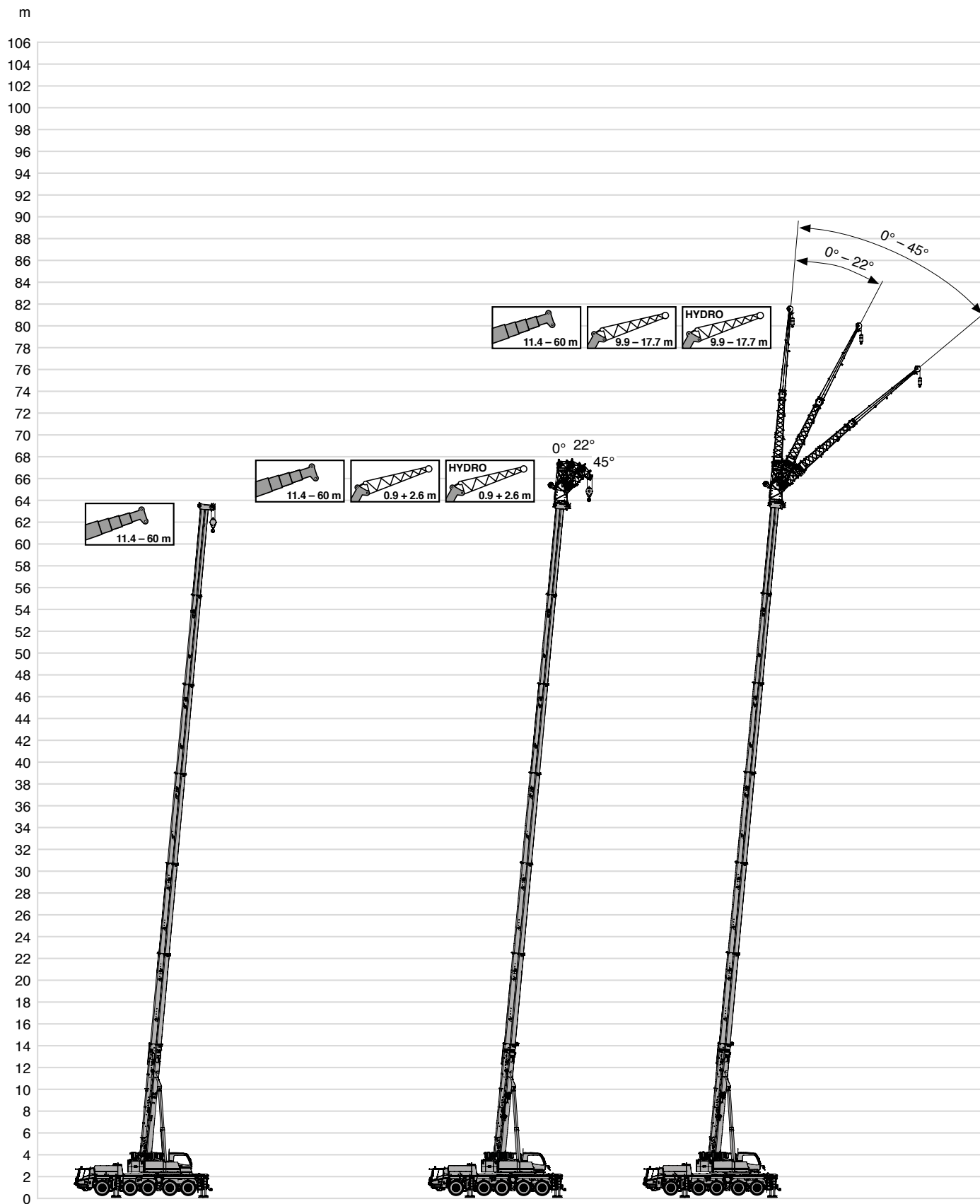

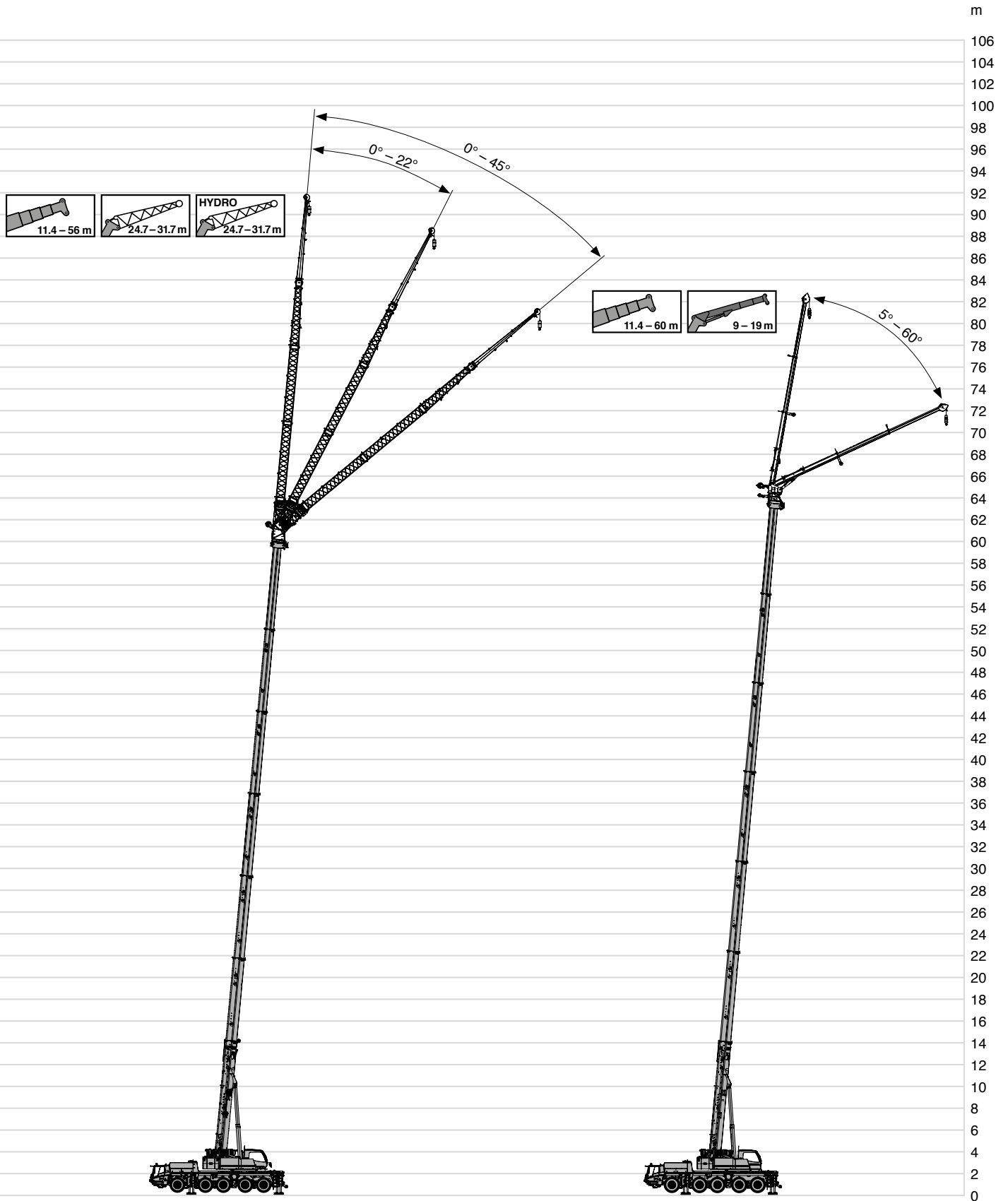



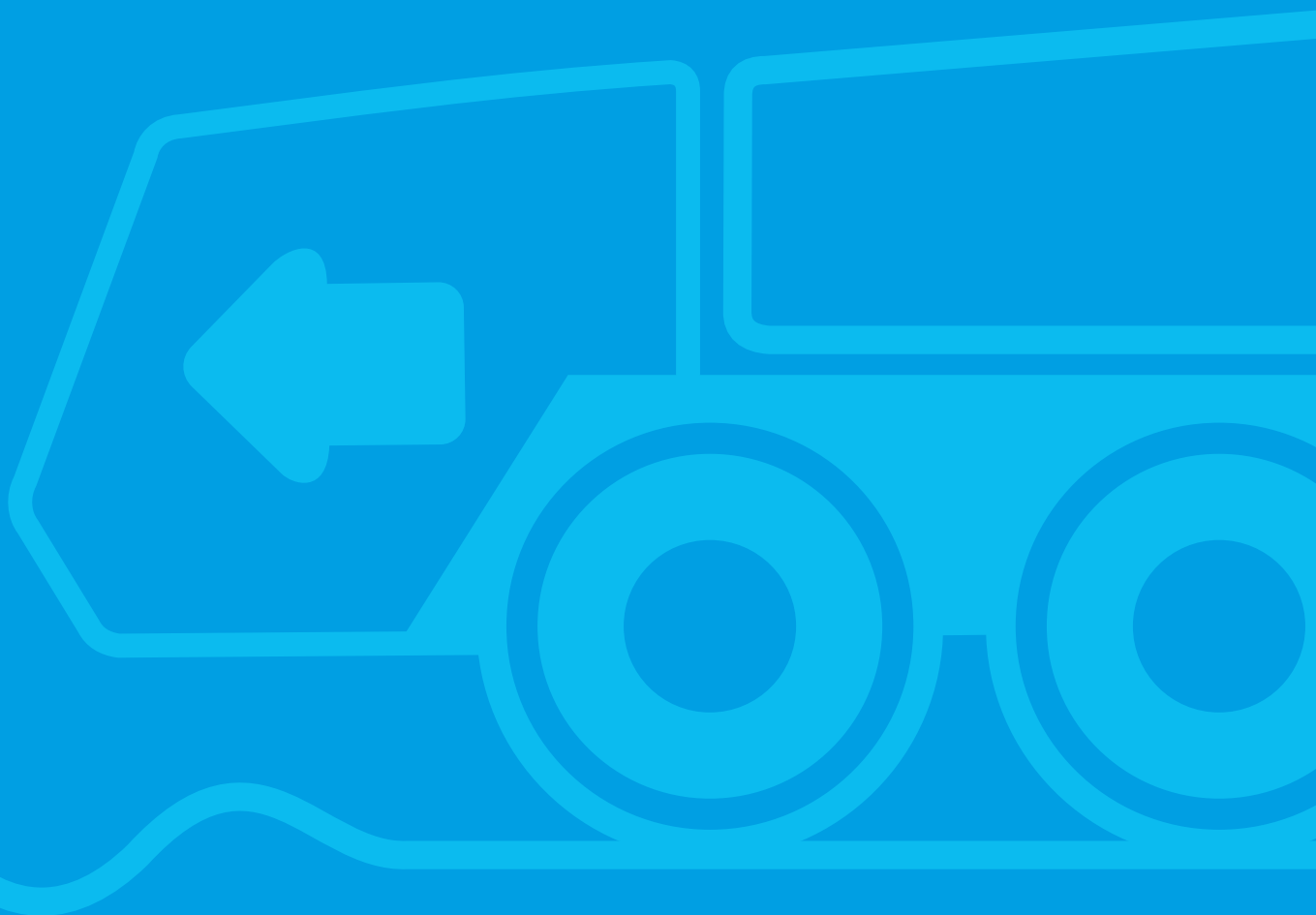

TECHNICAL DATA FOR ON-ROAD AND OFF-ROAD DRIVING

TECHNISCHE DATEN FÜR DIE STRASSEN- UND GELÄNDEFAHRT
CARACTÉRISTIQUES TECHNIQUES POUR MARCHE ROUTE ET TOUT TERRAIN
DATOS TÉCNICOS PARA SU TRASLADO POR CARRETERA Y TODO TERRENO
DATI TECNICI PER MARCIA SU STRADA E FUORI STRADA
ТЕХНИЧЕСКИЕ ХАРАКТЕРИСТИКИ ПРИ ДВИЖЕНИИ ПО ДОРОГАМ И БЕЗДОРОЖЬЮ



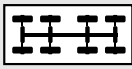

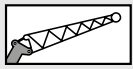





On-road and off-road driving · Straßen- und Geländefahrt · Marche route et tout terrain
 Traslado por carretera y todoterreno · Marcia su strada e fuori strada
 Движение по дорогам и бездорожью

Axle loads · Achslasten · Charges par essieu
 Cargas por eje · Carichi assiali · Нагрузка на ось



	TOTAL			TYPE		
< 10 t	< 48 t	10 x 8	445/95 R 25	10	-	0 t
< 10 t	< 50 t ***	10 x 8	445/95 R 25	63	-	1.3 t
< 12 t	< 60 t ***	10 x 8	445/95 R 25	63 / 10	0.9 m + 16.8 m	9.2 t
< 12 t	< 60 t ***	10 x 8	445/95 R 25	63	-	11.5 t
< 13 t	< 65 t ***	10 x 8	445/95 R 25	63 / 10	0.9 m + 16.8 m	13.2 t
max **	87 t ***	10 x 8	445/95 R 25	32 / 10	0.9 m + 30.8 m	35.4 t

* Axle loads vary depending on equipment mounted. Individual calculation available on demand. · Achslasten variieren je nach Ausrüstungsumfang. Individuelle Berechnung auf Anfrage.
 Las cargas por ejes pueden variar según el equipamiento. Cálculo individual sobre pedido. · Les charges par essieux peuvent varier en fonction de l'équipement monté. Calcul individuel sur demande.
 I carichi degli assi variano in base all'entità dell'equipaggiamento. Calcolo individuale su richiesta. · Нагрузка на оси зависит от установленного оборудования. Индивидуальный расчет по запросу.
 ** Construction site · Baustelle · Chantier de construction · Obra · Cantiere · стройплощадка
 *** Incl. second winch or balancing weight · Inklusive zweite Winde oder Ausgleichsgewicht · Y compris deuxième treuil ou contrepoids d'équilibre
 Incl. segundo cabrestante o peso de compensación · Incluso secondo argano o contrappeso · Включая вторую лебёдку или противовес

Speeds and gradeability · Geschwindigkeiten und Steigfähigkeit · Vitesses de conduite et gravissement de pente
 Velocidades y pendientes superables · Velocità e pendenza · Скорость и грузоподъемность

	 	 	 	 
385/95 R 25	85 km/h max.	39 km/h max.	64 %	72 %
445/95 R 25 525/80 R 25	85 km/h max.	42 km/h max.	58 %	63 %

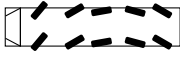
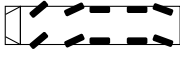
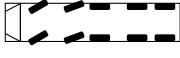
Steering · Lenkung · Direction
 Dirección · Sterzo · Рулевое управление

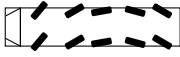
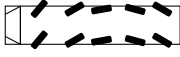
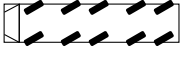
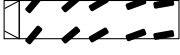
	 v < 25 km/h
	 25 km/h ≤ v ≤ 50 km/h
	 v > 50 km/h
	 Manual steering · Manuelle Lenkung · Direction manuelle Dirección manual · Sterzo manuale · Ручное управление
	 Smallest turning circle · Kleinster Wendekreis · Rayon de braquage mini. Mínimo radio · Raggio di sterzata minimo · Минимальный радиус поворота
	 Diagonal steering · Hundegang · Marche en crabe Marcha cangrejo · Sterzatura carrello · Движение по диагонали
	 Rear veering suppression · Heck-Ausscher-Unterdrückung Suppression de déboîtement AR · Supresión de movimiento transversal de parte posterior Soppressione oscillazione coda veicolo · Компенсация выноса задней части крана

TECHNICAL DATA FOR TRANSPORT

TECHNISCHE DATEN FÜR DEN TRANSPORT
CARACTÉRISTIQUES TECHNIQUES POUR LE TRANSPORT
DATOS TÉCNICOS PARA EL TRANSPORTE
DATI TECNICI PER IL TRASPORTO
ТЕХНИЧЕСКИЕ ДАННЫЕ ДЛЯ ТРАНСПОРТИРОВКИ



Transport · Transporte
 Trasporto · Транспортировка

Counterweight · Gegengewicht · Contrepoids
 Contrapeso · Contrappeso · Противовес

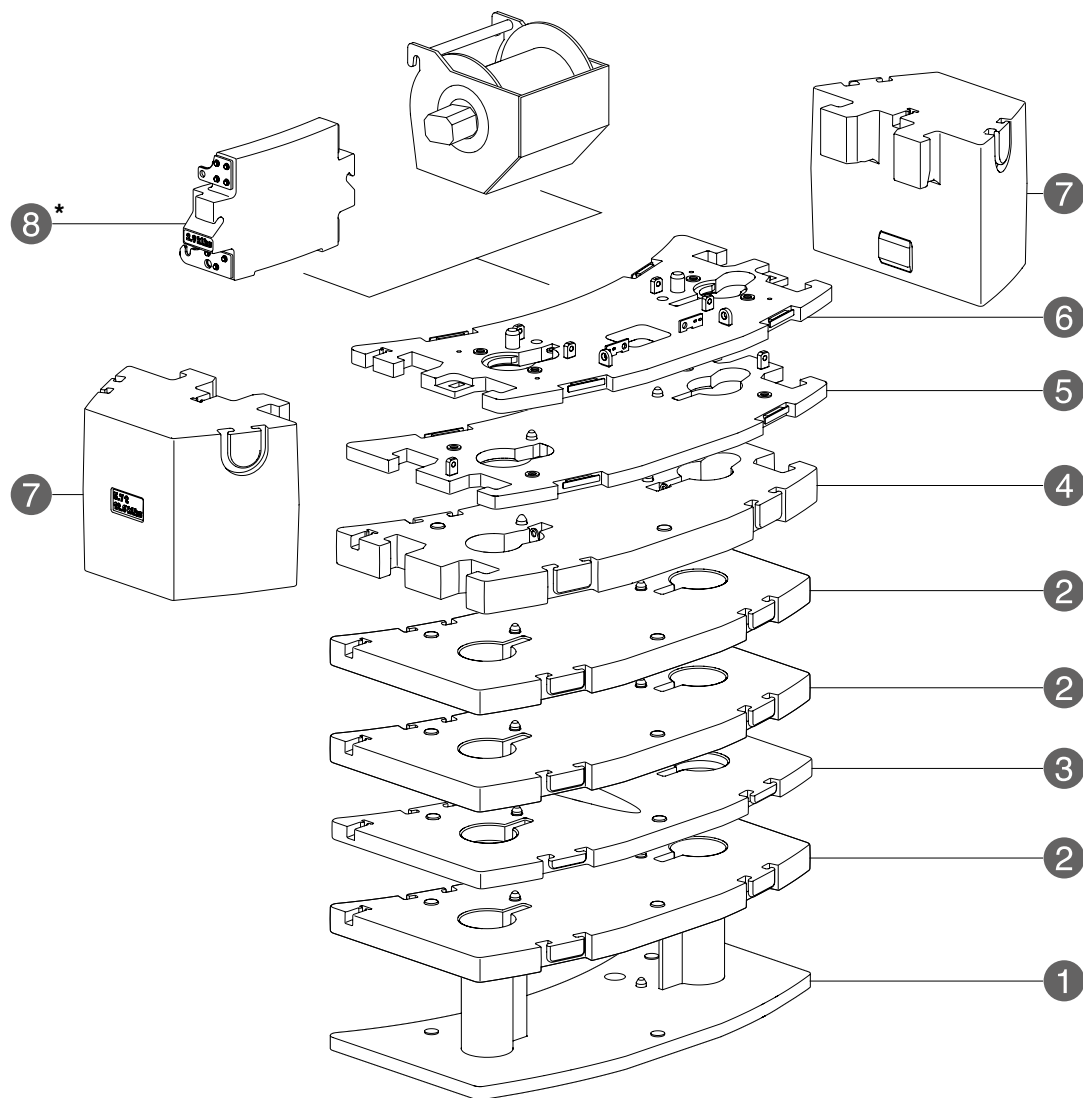

		1.3 t	3.1 t	4.8 t	5.8 t	7.5 t	9.2 t	10.9 t	11.5 t	13.2 t	14.9 t	16.6 t	18.3 t	20 t	22.3 t	24 t	35.4 t
①	2.7 t	-	-	-	1	1	1	1	1	1	1	1	1	1	1	1	1
②	3.4 t	-	-	-	-	-	1	1	1	1	2	2	3	3	3	3	3
③	2.3 t	-	-	-	-	-	-	-	1	1	1	1	1	1	1	1	1
④	4.0 t	-	-	-	-	-	-	-	-	-	-	-	-	-	1	1	1
⑤	1.7 t	-	-	1	-	1	-	1	-	1	-	1	-	1	-	1	1
⑥	1.8 t	-	1	1	1	1	1	1	1	1	1	1	1	1	1	1	1
⑦	5.7 t	-	-	-	-	-	-	-	-	-	-	-	-	-	-	-	2
⑧*	1.3 t	1	1	1	1	1	1	1	1	1	1	1	1	1	1	1	1

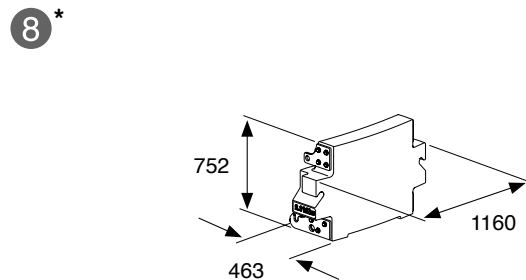
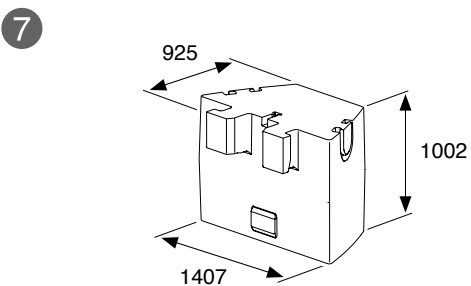
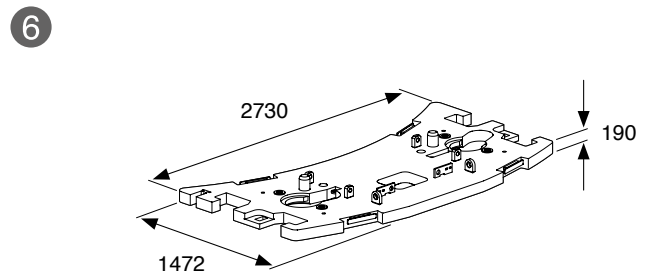
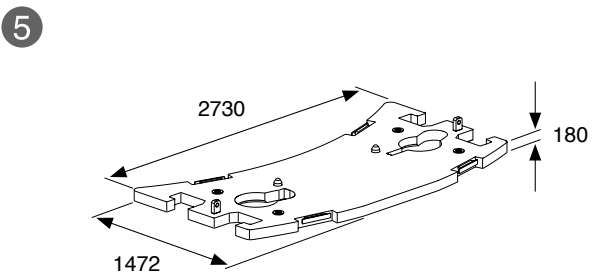
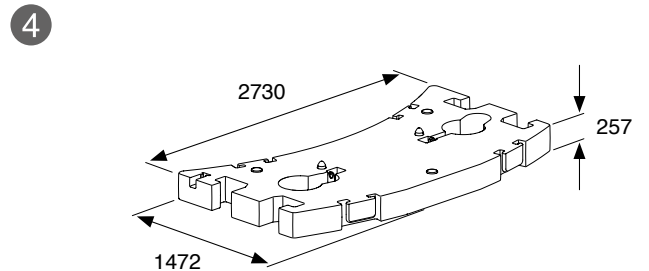
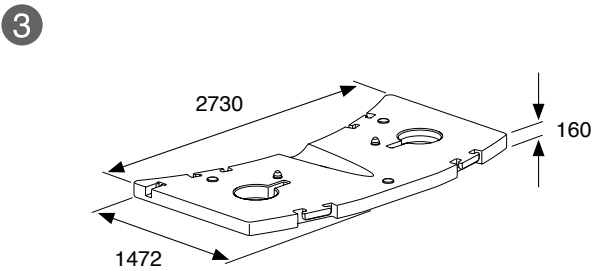
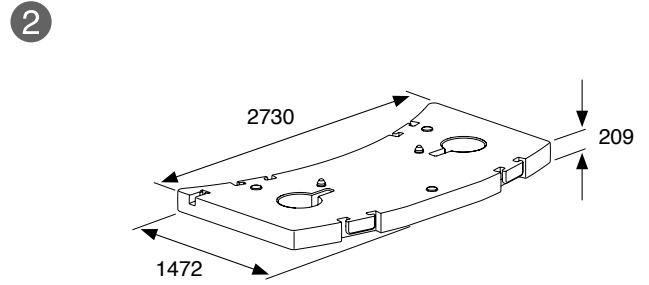
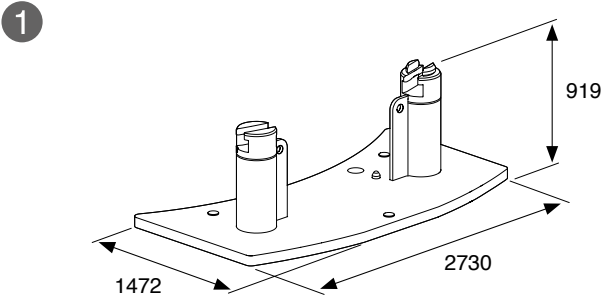

* Can be replaced by 2nd winch · Ersetzbar durch 2. Winde · Peut être remplacé par un 2^e treuil · Sostituibile per 2^a cabrestante · Sostituibile con 2^a argano · Возможность замены на 2-ю лебедку



* Can be replaced by 2nd winch · Ersetzbar durch 2. Winde · Peut être remplacé par un 2^e treuil · Sustituible por 2^o cabrestante · Sostituibile con 2^o argano · Возможность замены на 2-ю лебедку

Transport · Transporte
 Trasporto · Транспортировка

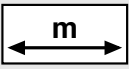
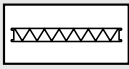
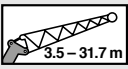
Jibs · Spitzen · Fléchettes
 Plumines · Punte · гусек

		
 	0.9 + 2.6 m	①
	0.9 m + 9.0 m	① + ③
	0.9 m + 16.8 m	① + ③ + ④
	0.9 m + 23.8 m	① + ② + ③ + ④
	0.9 m + 30.8 m	① + ② + ② + ③ + ④

①  838

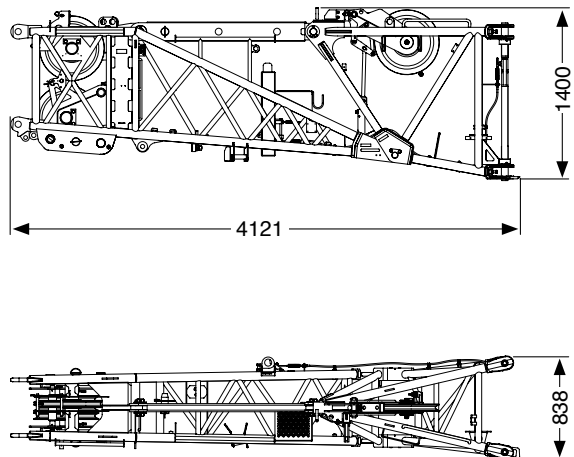

②  480

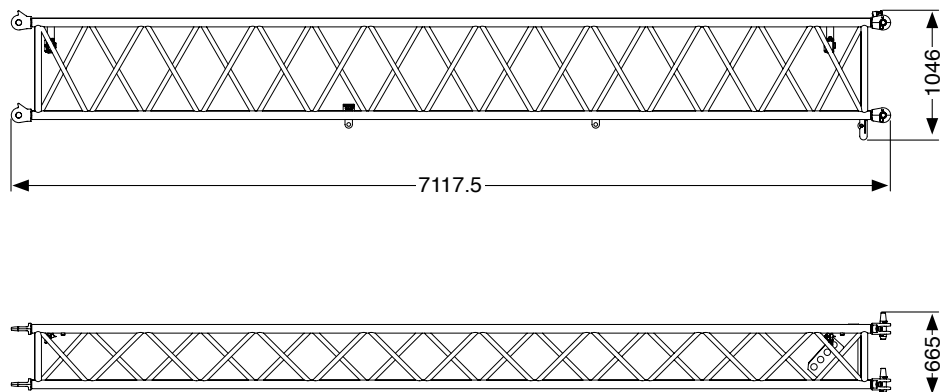

3 
470

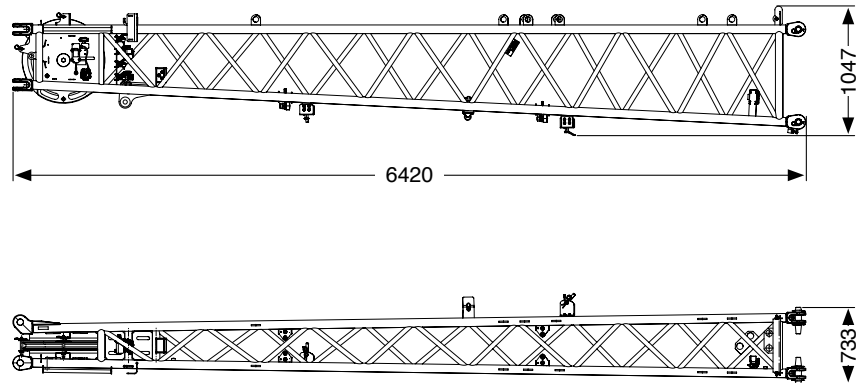

4 
425

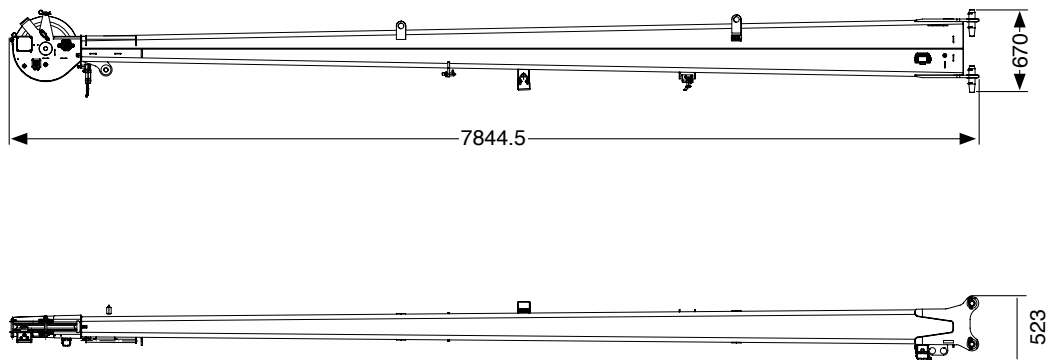

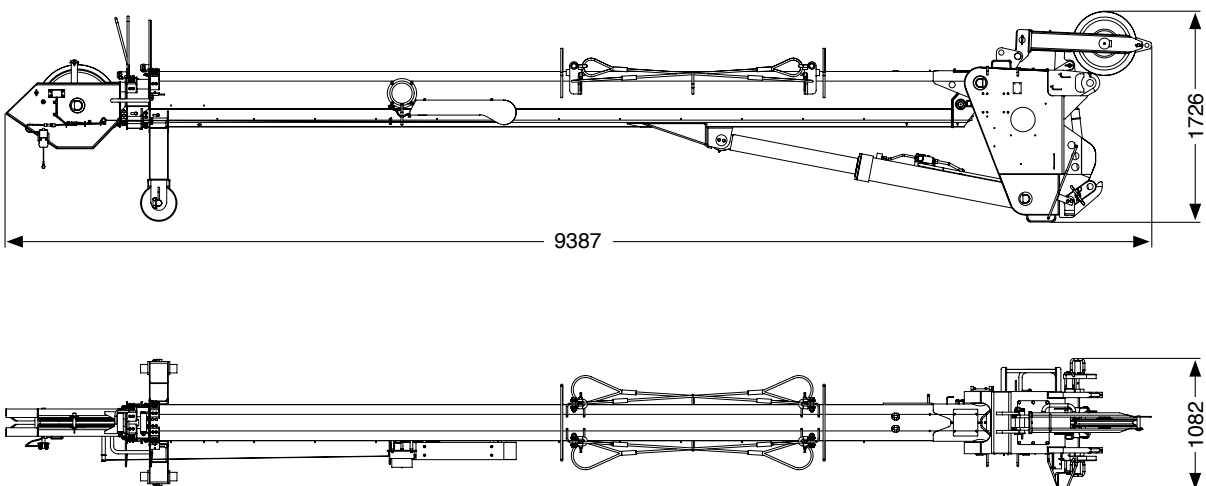

2240



Transport · Transporte
Trasporto · Транспортировка

Hose drum for hydraulic jib · Schlauchtrommel für hydraulische Spitze · Tambour de flexible pour fléchette hydraulique
Devanadera para plumin hidráulico · Aspo raccoglirubo per punta idraulica · Барабан для намотки шланга для гидравлического гуська

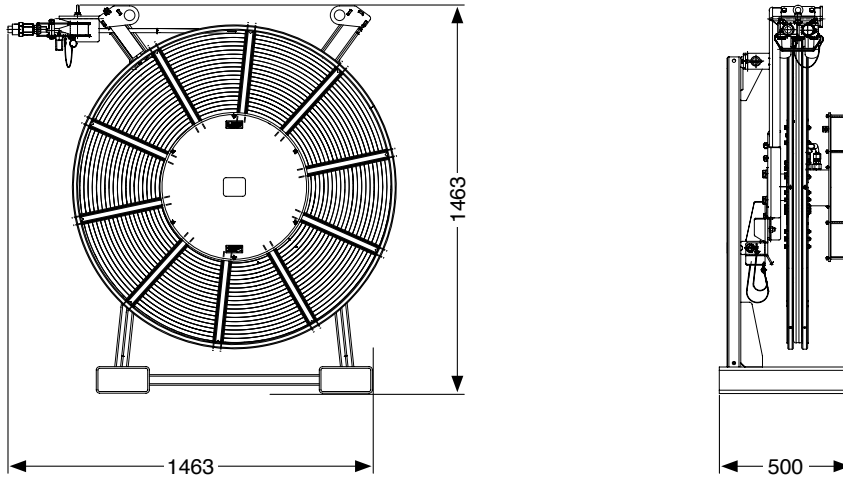
kg
222



Auxiliary winch · Zusatzhubwinde · Treuil supplémentaire
Cabrestante auxiliar · Argano aggiuntivo · Дополнительная лебедка

kg
695/
1235*

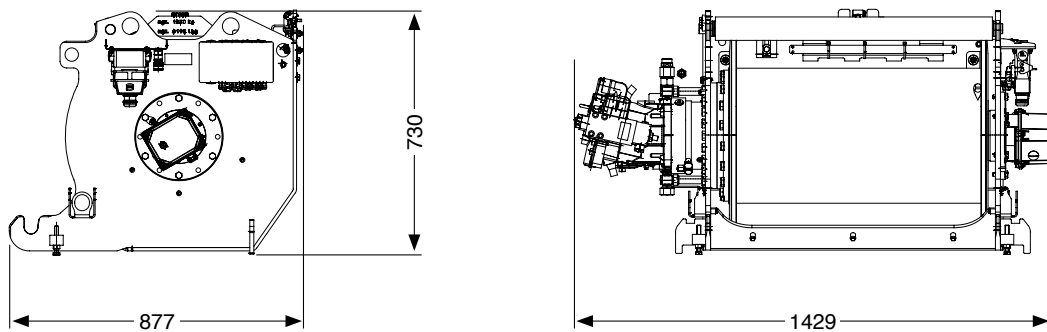

* with rope · mit Seil · avec câble · con cable · con fune · с тросом

TECHNICAL DATA FOR OPERATION

TECHNISCHE DATEN FÜR DEN EINSATZ

CARACTÉRISTIQUES TECHNIQUES POUR L'UTILISATION

DATOS TÉCNICOS PARA EL USO

DATI TECNICI PER L'USO

ТЕХНИЧЕСКИЕ ЭКСПЛУАТАЦИОННЫЕ ХАРАКТЕРИСТИКИ



Operation · Einsatz · Utilisation
 Uso · Эксплуатация





Main boom · Hauptausleger · Flèche principale
 Pluma principal · Braccio principale · Главная стрела

	- 1° – 84.7°	~ 45 s
	11.4 m – 60 m	~ 560 s





Swing mechanism · Drehwerk · Groupe de rotation
 Mecanismo de giro · Gruppo di rotazione · Поворотный механизм

	0 – 2 min ⁻¹		0° / 180°
---	-------------------------	---	-----------

Winches · Hubwinden · Treuils
 Cabrestantes · Argani · Лебедка

			
	0 – 115 m/min	21 mm / 250 m	85
	0 – 115 m/min	21 mm / 250 m	85

Hook blocks · Unterflaschen · Moufles
 Pastecas de carga · Bozzelli · Крюковые обоймы

 TYPE				
160*	120	7	15	1300
100*	91.7	5	11	800
63*	59	3	7	600
63	59	3	7	600
32	25.6	1	3	450
10	8.7	-	1	300

* Twin hook · Doppelhaken · Moufle avec crochet marin · Gancho doble · Gancio doppio · Двойной крюк

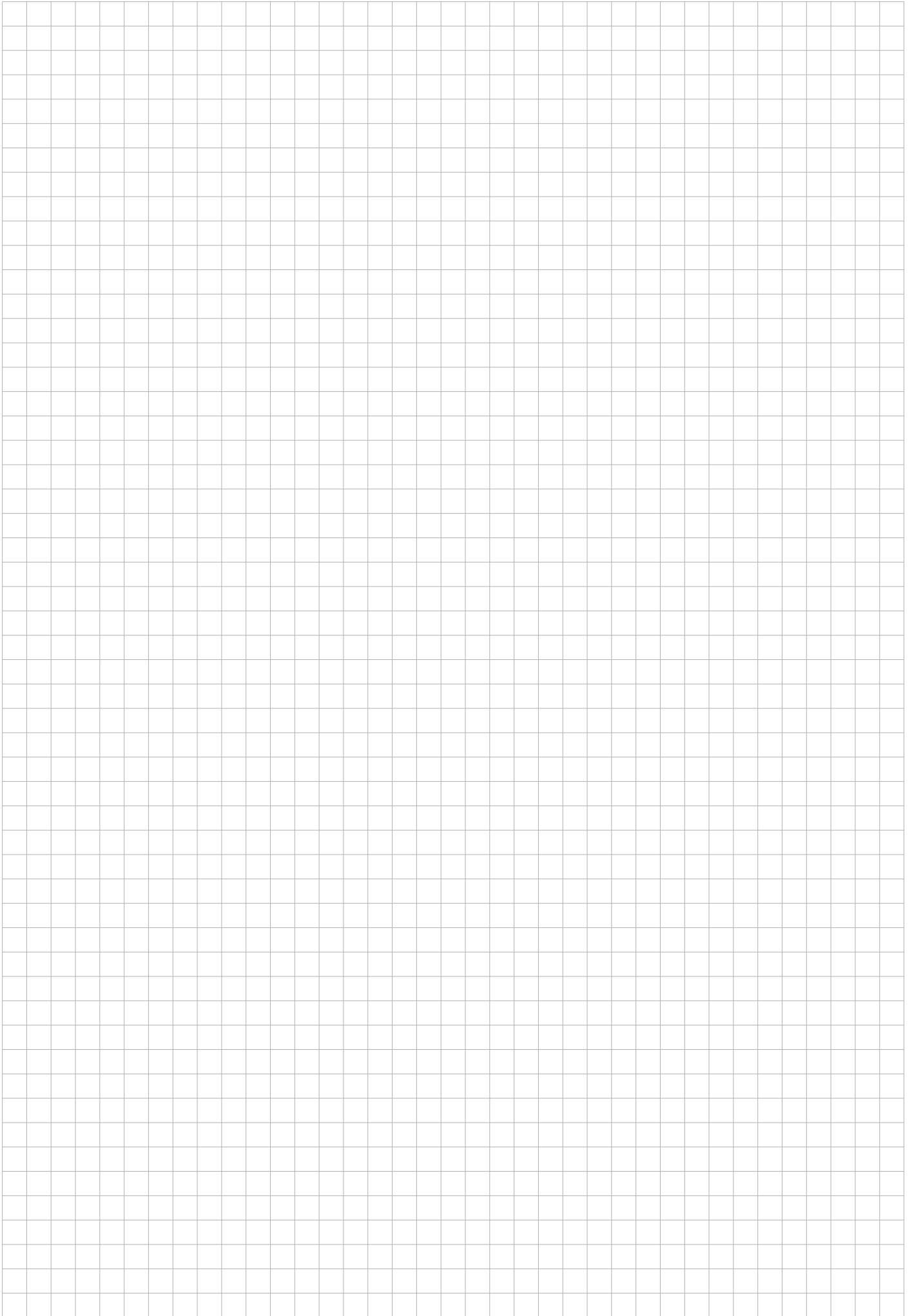

Operation · Einsatz · Utilisation
 Uso · Эксплуатация

Working range · Arbeitsbereich · Rayon de travail
 Zona de trabajo · Area di lavoro · Рабочая зона

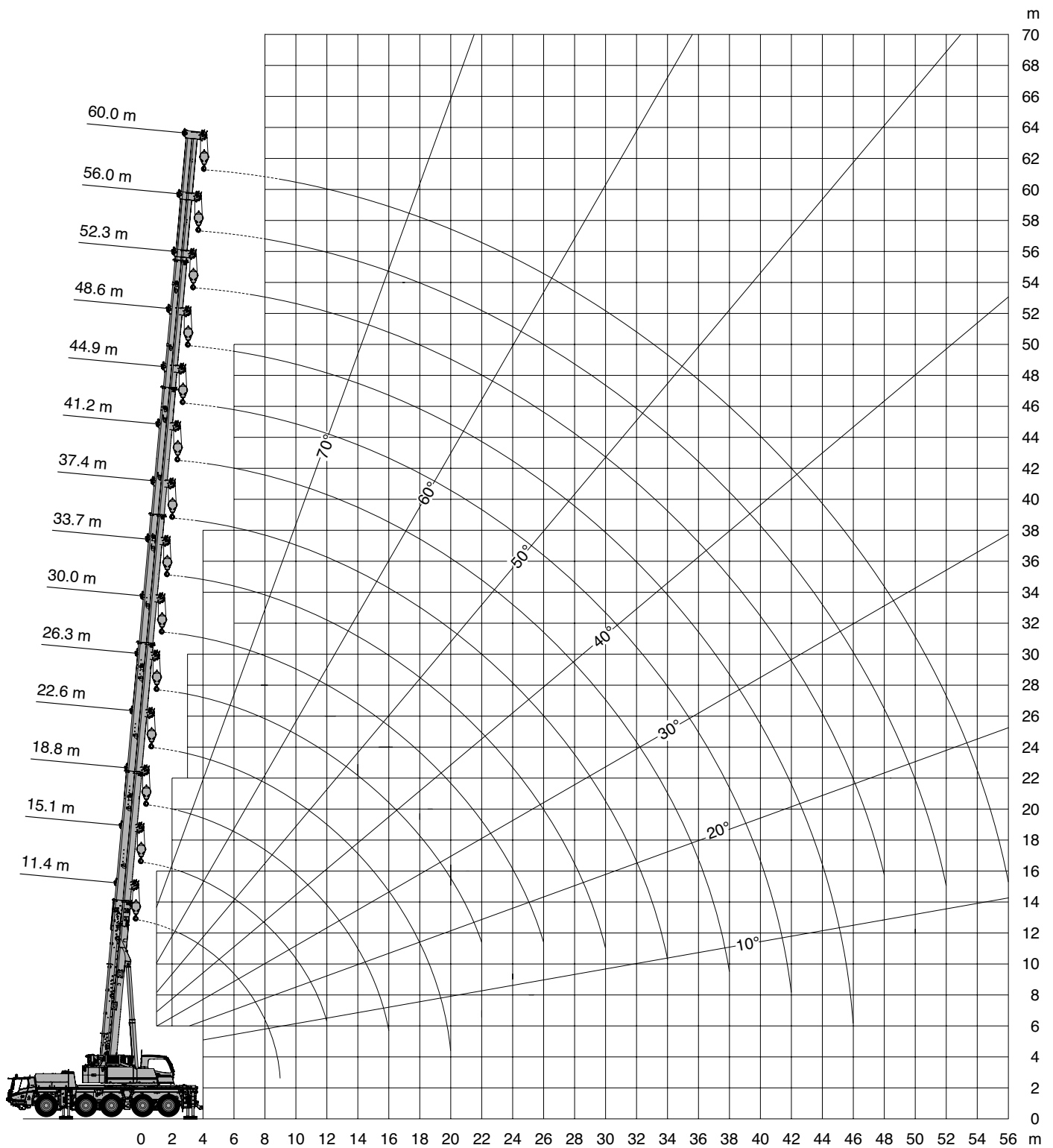



m	11.4 m*	11.4 m	15.1 m	18.8 m	22.6 m	26.3 m	30.0 m	33.7 m	37.4 m	41.2 m	44.9 m	48.6 m	52.3 m	56.0 m	60.0 m
2.5	120.0**	113.9**	63.5	63.5	59.7	46.3	36.9								
3.0	105.7**	102.9**	63.5	63.5	59.7	46.3	36.9	29.3							
3.5	96.5	93.6	63.5	63.5	59.7	46.3	36.9	29.3	23.7						
4.0	84.6	84.6	63.5	63.5	59.6	46.3	36.9	29.3	23.8						
4.5	74.8	74.8	63.5	63.5	59.6	46.3	36.9	29.3	23.8	19.1					
5.0	67.0	67.0	63.5	63.5	59.6	46.3	36.9	29.3	23.8	19.1	15.9				
6.0	55.1	55.1	55.1	55.5	55.4	45.2	36.9	29.3	23.8	19.1	16.0	12.5			
7.0	46.6	46.6	46.6	47.1	46.8	44.6	34.6	29.3	23.8	19.1	16.0	12.5	10.3		
8.0	40.2	40.2	40.2	40.6	40.4	40.0	34.4	28.6	23.8	19.1	16.0	12.5	10.3	8.4	
9.0	35.2	35.2	35.2	35.6	36.2	35.9	34.4	27.7	23.7	19.1	16.0	12.5	10.3	8.4	7.3
10.0			31.1	32.2	32.2	31.9	31.5	27.5	22.7	19.1	16.0	12.5	10.3	8.4	7.3
11.0			27.9	28.9	28.8	28.6	28.2	26.1	21.9	19.1	16.0	12.5	10.3	8.4	7.3
12.0			25.1	26.1	26.1	25.8	25.4	24.8	21.9	18.2	16.0	12.5	10.3	8.4	7.3
14.0				21.8	21.7	21.5	21.2	21.6	19.7	17.7	15.0	12.5	10.3	8.4	7.3
16.0				18.5	18.4	18.2	18.7	18.3	17.7	16.0	14.6	12.3	10.3	8.4	7.3
18.0					15.9	16.3	16.0	15.7	15.5	14.6	13.5	11.3	10.3	8.4	7.3
20.0					14.1	14.3	14.0	13.6	13.4	13.4	12.4	11.2	9.6	8.4	7.3
22.0						12.6	12.3	12.3	11.7	11.8	11.5	10.3	9.2	8.4	7.3
24.0							10.9	10.9	10.5	10.4	10.7	9.6	9.0	7.8	7.2
26.0							9.8	9.7	9.4	9.4	9.5	8.9	8.4	7.3	6.8
28.0								8.7	8.9	8.7	8.5	8.3	7.9	6.8	6.3
30.0								7.9	8.1	8.0	7.5	7.5	7.4	6.3	5.9
32.0									7.2	7.2	6.9	6.7	6.9	5.9	5.5
34.0									6.5	6.4	6.4	6.2	6.2	5.5	5.2
36.0										5.8	6.1	5.7	5.5	5.1	4.8
38.0										5.5	5.5	5.2	4.9	4.5	4.5
40.0											5.0	4.6	4.4	4.0	4.0
42.0											4.5	4.2	3.9	3.5	3.5
44.0												3.8	3.5	3.1	3.1
46.0												3.4	3.1	2.7	2.7
48.0													2.8	2.4	2.4
50.0														2.1	2.1
52.0														1.8	1.8
54.0															1.5
56.0															1.3

* Over rear · Nach hinten · A l'arrière · Hacia atrás · Indietro · Назад

** With additional lifting equipment · Mit Zusatzhubausrüstung · Avec équipement de levage supplémentaire

Con equipamiento de elevación adicional · Con attrezzaggio di sollevamento supplementare · С дополнительным подъемным оборудованием

Operation · Einsatz · Utilisation
 Uso · Эксплуатация



 m	11.4 m*	11.4 m	15.1 m	18.8 m	22.6 m	26.3 m	30.0 m	33.7 m	37.4 m	41.2 m	44.9 m	48.6 m	52.3 m	56.0 m	60.0 m
2.5	115.1**	113.0**	63.5	63.5	59.7	46.3	36.9								
3.0	104.8**	101.9**	63.5	63.5	59.7	46.3	36.9	29.3							
3.5	90.0	90.0	63.5	63.5	59.7	46.3	36.9	29.3	23.7						
4.0	78.4	78.4	63.5	63.5	59.6	46.3	36.9	29.3	23.8						
4.5	69.3	69.3	63.5	63.5	59.6	46.3	36.9	29.3	23.8	19.1					
5.0	62.0	62.0	61.6	61.3	59.6	46.3	36.9	29.3	23.8	19.1	15.9				
6.0	51.0	51.0	51.0	51.5	51.2	45.2	36.9	29.3	23.8	19.1	16.0	12.5			
7.0	43.0	43.0	43.0	43.5	43.3	42.9	34.6	29.3	23.8	19.1	16.0	12.5	10.3		
8.0	37.1	37.1	37.1	37.5	38.1	37.9	34.4	28.6	23.8	19.1	16.0	12.5	10.3	8.4	
9.0	32.4	32.4	32.4	33.4	33.4	33.2	32.7	27.7	23.7	19.1	16.0	12.5	10.3	8.4	7.3
10.0			28.6	29.7	29.7	29.4	29.0	27.5	22.7	19.1	16.0	12.5	10.3	8.4	7.3
11.0			26.0	26.5	26.5	26.2	25.8	26.1	21.9	19.1	16.0	12.5	10.3	8.4	7.3
12.0			23.5	23.8	23.8	23.5	23.4	23.7	21.9	18.2	16.0	12.5	10.3	8.4	7.3
14.0				19.7	19.6	19.7	19.9	19.5	18.9	17.7	15.0	12.5	10.3	8.4	7.3
16.0				16.6	16.5	17.0	16.8	16.5	15.7	15.3	14.6	12.3	10.3	8.4	7.3
18.0					14.4	14.3	13.9	13.9	13.5	12.9	13.1	11.3	10.3	8.4	7.3
20.0					12.2	12.0	11.7	11.6	11.4	11.7	11.2	11.0	9.6	8.4	7.3
22.0						10.2	9.9	10.0	10.2	10.2	9.9	9.5	9.2	8.4	7.3
24.0							8.5	8.9	8.9	8.7	8.5	8.7	8.5	7.8	7.2
26.0							7.6	7.7	7.7	7.6	7.9	7.6	7.3	6.9	6.7
28.0								6.8	6.7	7.1	6.9	6.6	6.3	5.9	5.9
30.0								5.9	5.9	6.2	6.1	5.7	5.5	5.1	5.1
32.0									5.2	5.5	5.3	5.0	4.8	4.4	4.4
34.0									4.6	4.9	4.7	4.4	4.2	3.8	3.7
36.0										4.3	4.2	3.9	3.6	3.2	3.2
38.0										3.9	3.7	3.4	3.1	2.7	2.7
40.0											3.3	3.0	2.7	2.3	2.3
42.0											2.9	2.6	2.3	1.9	1.9
44.0												2.2	2.0	1.6	1.6
46.0												2.0	1.7	1.3	1.3
48.0													1.4	1.0	1.0
50.0														0.8	0.7
52.0														0.6	0.5



 m	11.4 m*	11.4 m	15.1 m	18.8 m	22.6 m	26.3 m	30.0 m	33.7 m	37.4 m	41.2 m	44.9 m	48.6 m	52.3 m	56.0 m	60.0 m
2.5	115.1**	112.8**	63.5	63.5	59.7	46.3	36.9								
3.0	103.6**	101.7**	63.5	63.5	59.7	46.3	36.9	29.3							
3.5	88.9	88.9	63.5	63.5	59.7	46.3	36.9	29.3	23.7						
4.0	77.4	77.4	63.5	63.5	59.6	46.3	36.9	29.3	23.8						
4.5	68.5	68.5	63.5	63.5	59.6	46.3	36.9	29.3	23.8	19.1					
5.0	61.2	61.2	60.8	60.5	59.6	46.3	36.9	29.3	23.8	19.1	15.9				
6.0	50.3	50.3	50.3	50.8	50.6	45.2	36.9	29.3	23.8	19.1	16.0	12.5			
7.0	42.5	42.5	42.5	42.9	42.7	42.3	34.6	29.3	23.8	19.1	16.0	12.5	10.3		
8.0	36.6	36.6	36.6	37.1	37.6	37.4	34.4	28.6	23.8	19.1	16.0	12.5	10.3	8.4	
9.0	32.0	32.0	31.9	33.0	33.0	32.7	32.3	27.7	23.7	19.1	16.0	12.5	10.3	8.4	7.3
10.0			28.2	29.2	29.2	29.0	28.5	27.5	22.7	19.1	16.0	12.5	10.3	8.4	7.3
11.0			25.7	26.0	26.0	25.8	25.3	25.9	21.9	19.1	16.0	12.5	10.3	8.4	7.3
12.0			23.1	23.4	23.4	23.1	23.4	23.2	21.9	18.2	16.0	12.5	10.3	8.4	7.3
14.0				19.3	19.3	19.7	19.5	18.8	18.1	17.6	15.0	12.5	10.3	8.4	7.3
16.0				16.0	16.3	16.6	16.2	16.1	15.3	14.6	14.4	12.3	10.3	8.4	7.3
18.0					13.8	13.6	13.3	13.2	12.8	12.9	12.4	11.3	10.3	8.4	7.3
20.0					11.6	11.4	11.1	11.3	11.4	11.3	10.8	10.4	9.6	8.4	7.3
22.0						9.7	9.4	9.8	9.8	9.7	9.4	9.4	9.2	8.4	7.3
24.0							8.1	8.4	8.4	8.3	8.5	8.3	8.0	7.4	7.2
26.0							7.5	7.3	7.3	7.6	7.5	7.2	6.9	6.4	6.3
28.0								6.4	6.3	6.7	6.5	6.2	5.9	5.6	5.5
30.0								5.8	5.5	5.9	5.7	5.4	5.1	4.7	4.7
32.0									4.8	5.2	5.0	4.7	4.4	4.1	4.0
34.0									4.3	4.6	4.4	4.1	3.8	3.5	3.4
36.0										4.0	3.9	3.6	3.3	2.9	2.9
38.0										3.6	3.4	3.1	2.9	2.5	2.4
40.0											3.0	2.7	2.4	2.1	2.0
42.0											2.7	2.3	2.1	1.7	1.7
44.0												2.0	1.8	1.4	1.3
46.0												1.7	1.5	1.1	1.0
48.0													1.2	0.8	0.8
50.0														0.6	0.5

* Over rear · Nach hinten · A l'arrière · Hacia atrás · Indietro · Hazað

** With additional lifting equipment · Mit Zusatzhubausrüstung · Avec équipement de levage supplémentaire

Con equipamiento de elevación adicional · Con attrezzaggio di sollevamento supplementare · С дополнительным подъемным оборудованием



 m	11.4 m*	11.4 m	15.1 m	18.8 m	22.6 m	26.3 m	30.0 m	33.7 m	37.4 m	41.2 m	44.9 m	48.6 m	52.3 m	56.0 m	60.0 m
2.5	115.1**	112.5**	63.5	63.5	59.7	46.3	36.9								
3.0	102.0**	101.4**	63.5	63.5	59.7	46.3	36.9	29.3							
3.5	87.4	87.4	63.5	63.5	59.7	46.3	36.9	29.3	23.7						
4.0	76.1	76.1	63.5	63.5	59.6	46.3	36.9	29.3	23.8						
4.5	67.3	67.3	63.5	63.5	59.6	46.3	36.9	29.3	23.8	19.1					
5.0	60.1	60.1	59.7	59.5	59.3	46.3	36.9	29.3	23.8	19.1	15.9				
6.0	49.4	49.4	49.4	49.9	49.7	45.2	36.9	29.3	23.8	19.1	16.0	12.5			
7.0	41.7	41.7	41.7	42.2	41.9	41.6	34.6	29.3	23.8	19.1	16.0	12.5	10.3		
8.0	35.9	35.9	35.9	36.9	36.9	36.7	34.4	28.6	23.8	19.1	16.0	12.5	10.3	8.4	
9.0	31.4	31.4	31.3	32.4	32.4	32.1	31.7	27.7	23.7	19.1	16.0	12.5	10.3	8.4	7.3
10.0			27.7	28.6	28.5	28.3	27.8	27.0	22.7	19.1	16.0	12.5	10.3	8.4	7.3
11.0			25.1	25.4	25.4	25.2	24.7	24.6	21.9	19.1	16.0	12.5	10.3	8.4	7.3
12.0			22.5	22.9	22.8	22.6	23.1	21.9	20.9	18.2	16.0	12.5	10.3	8.4	7.3
14.0				18.8	18.7	19.3	18.8	18.2	17.2	16.4	15.0	12.5	10.3	8.4	7.3
16.0				14.9	15.7	15.6	15.2	15.1	14.2	14.1	13.7	12.3	10.3	8.4	7.3
18.0					12.9	12.7	12.4	12.6	12.4	12.1	11.8	11.3	10.3	8.4	7.3
20.0					10.8	10.7	10.3	10.6	10.8	10.7	10.2	10.0	9.2	8.4	7.3
22.0						9.1	8.8	9.1	9.1	9.0	9.1	8.9	8.5	7.8	7.3
24.0							8.0	7.8	7.8	8.1	8.0	7.7	7.3	6.7	6.6
26.0								6.9	6.7	6.7	6.9	6.6	6.3	5.8	5.7
28.0									6.1	5.8	6.0	5.7	5.4	5.0	4.9
30.0									5.6	5.0	5.4	5.2	4.9	4.3	4.2
32.0										4.4	4.7	4.6	4.0	3.6	3.6
34.0										3.9	4.1	4.0	3.4	3.0	3.0
36.0											3.6	3.5	3.2	2.9	2.5
38.0											3.2	3.1	2.7	2.5	2.1
40.0												2.7	2.3	2.1	1.7
42.0												2.3	2.0	1.7	1.4
44.0													1.7	1.4	1.0
46.0													1.4	1.2	0.8
48.0														0.9	0.5



 m	11.4 m*	11.4 m	15.1 m	18.8 m	22.6 m	26.3 m	30.0 m	33.7 m	37.4 m	41.2 m	44.9 m	48.6 m	52.3 m	56.0 m	60.0 m
2.5	115.1**	112.3**	63.5	63.5	59.7	46.3	36.9								
3.0	100.8**	100.8**	63.5	63.5	59.7	46.3	36.9	29.3							
3.5	86.3	86.3	63.5	63.5	59.7	46.3	36.9	29.3	23.7						
4.0	75.1	75.1	63.5	63.5	59.6	46.3	36.9	29.3	23.8						
4.5	66.4	66.4	63.5	63.5	59.6	46.3	36.9	29.3	23.8	19.1					
5.0	59.4	59.4	59.4	59.2	58.7	46.3	36.9	29.3	23.8	19.1	15.9				
6.0	48.7	48.7	48.8	49.2	49.0	45.2	36.9	29.3	23.8	19.1	16.0	12.5			
7.0	41.1	41.1	41.1	41.6	41.4	41.0	34.6	29.3	23.8	19.1	16.0	12.5	10.3		
8.0	35.4	35.4	35.4	36.4	36.4	36.2	34.4	28.6	23.8	19.1	16.0	12.5	10.3	8.4	
9.0	30.8	30.8	30.8	31.9	31.9	31.6	31.1	27.7	23.7	19.1	16.0	12.5	10.3	8.4	7.3
10.0			27.7	28.1	28.1	27.8	26.9	26.3	22.7	19.1	16.0	12.5	10.3	8.4	7.3
11.0			24.6	25.0	25.0	24.7	24.7	23.4	21.9	19.1	16.0	12.5	10.3	8.4	7.3
12.0			22.1	22.4	22.4	22.2	22.2	20.9	19.9	18.2	16.0	12.5	10.3	8.4	7.3
14.0				17.9	17.9	18.6	17.9	17.3	16.3	15.7	14.6	12.5	10.3	8.4	7.3
16.0				14.3	14.9	14.8	14.5	14.3	13.5	13.6	12.9	12.1	10.3	8.4	7.3
18.0					12.2	12.1	11.8	12.0	12.2	11.9	11.2	10.7	10.0	8.4	7.3
20.0					10.3	10.1	9.8	10.2	10.2	10.1	9.8	9.7	9.2	8.4	7.3
22.0						8.5	8.8	8.6	8.6	8.7	8.9	8.4	7.9	7.3	7.1
24.0							7.6	7.4	7.3	7.7	7.6	7.2	6.9	6.3	6.1
26.0								6.5	6.5	6.7	6.5	6.2	5.9	5.4	5.3
28.0									6.0	5.4	5.8	5.6	5.0	4.6	4.5
30.0									5.3	4.7	5.0	4.9	4.6	4.3	3.9
32.0										4.1	4.4	4.2	3.9	3.7	3.3
34.0										3.5	3.8	3.7	3.4	3.1	2.7
36.0											3.4	3.2	2.9	2.6	2.2
38.0											2.9	2.8	2.5	2.2	1.8
40.0												2.4	2.1	1.8	1.4
42.0												2.1	1.8	1.5	1.1
44.0													1.5	1.2	0.8
46.0														0.9	0.6
48.0															0.5

* Over rear · Nach hinten · A l'arrière · Hacia atrás · Indietro · Назад

** With additional lifting equipment · Mit Zusatzhubausrüstung · Avec équipement de levage supplémentaire

Con equipamiento de elevación adicional · Con attrezzaggio di sollevamento supplementare · С дополнительным подъемным оборудованием

Operation · Einsatz · Utilisation
 Uso · Эксплуатация



 m	11.4 m*	11.4 m	15.1 m	18.8 m	22.6 m	26.3 m	30.0 m	33.7 m	37.4 m	41.2 m	44.9 m	48.6 m	52.3 m	56.0 m	60.0 m
2.5	115.1**	112.0**	63.5	63.5	59.7	46.3	36.9								
3.0	99.7**	99.7**	63.5	63.5	59.7	46.3	36.9	29.3							
3.5	85.1	85.1	63.5	63.5	59.7	46.3	36.9	29.3	23.7						
4.0	74.1	74.1	63.5	63.5	59.6	46.3	36.9	29.3	23.8						
4.5	65.5	65.5	63.5	63.5	59.6	46.3	36.9	29.3	23.8	19.1					
5.0	58.6	58.6	58.6	58.4	57.9	46.3	36.9	29.3	23.8	19.1	15.9				
6.0	48.1	48.1	48.1	48.6	48.3	45.2	36.9	29.3	23.8	19.1	16.0	12.5			
7.0	40.6	40.6	40.6	41.0	40.8	40.4	34.6	29.3	23.8	19.1	16.0	12.5	10.3		
8.0	34.9	34.9	34.9	35.9	35.9	35.7	34.4	28.6	23.8	19.1	16.0	12.5	10.3	8.4	
9.0	30.3	30.3	30.2	31.3	31.3	31.0	29.7	27.7	23.7	19.1	16.0	12.5	10.3	8.4	7.3
10.0			27.2	27.6	27.6	27.3	26.2	25.4	22.7	19.1	16.0	12.5	10.3	8.4	7.3
11.0			24.2	24.5	24.5	23.9	23.8	22.4	21.3	19.1	16.0	12.5	10.3	8.4	7.3
12.0			21.7	22.0	22.0	21.9	21.1	20.3	19.2	18.1	16.0	12.5	10.3	8.4	7.3
14.0				17.0	17.8	17.7	17.0	16.4	15.5	15.4	14.5	12.5	10.3	8.4	7.3
16.0				14.0	14.2	14.0	13.7	13.8	13.4	13.3	12.5	11.4	10.3	8.4	7.3
18.0					11.6	11.5	11.1	11.5	11.6	11.2	10.6	10.0	9.3	8.4	7.3
20.0					9.7	9.5	9.6	9.7	9.7	9.5	9.7	9.1	8.6	8.0	7.3
22.0						8.0	8.3	8.1	8.1	8.5	8.3	7.9	7.4	6.8	6.6
24.0							7.1	7.0	6.9	7.3	7.1	6.8	6.4	5.8	5.6
26.0							6.1	6.5	5.9	6.2	6.1	5.8	5.5	5.0	4.8
28.0								5.6	5.0	5.4	5.2	4.9	4.7	4.2	4.1
30.0								4.9	4.3	4.7	4.5	4.2	3.9	3.6	3.5
32.0									3.7	4.1	3.9	3.6	3.3	2.9	2.9
34.0									3.2	3.5	3.4	3.1	2.8	2.4	2.4
36.0										3.1	2.9	2.6	2.3	2.0	1.9
38.0										2.7	2.5	2.2	1.9	1.6	1.5
40.0											2.2	1.8	1.6	1.2	1.2
42.0											1.9	1.5	1.3	0.9	0.9
44.0												1.2	1.0	0.6	0.6
46.0												1.0	0.7		
48.0													0.5		



 m	11.4 m*	11.4 m	15.1 m	18.8 m	22.6 m	26.3 m	30.0 m	33.7 m	37.4 m	41.2 m	44.9 m	48.6 m	52.3 m	56.0 m	60.0 m
2.5	115.1**	111.8**	63.5	63.5	59.7	46.3	36.9								
3.0	98.4	98.4	63.5	63.5	59.7	46.3	36.9	29.3							
3.5	84.0	84.0	63.5	63.5	59.7	46.3	36.9	29.3	23.7						
4.0	73.1	73.1	63.5	63.5	59.6	46.3	36.9	29.3	23.8						
4.5	64.6	64.6	63.5	63.5	59.6	46.3	36.9	29.3	23.8	19.1					
5.0	57.8	57.8	57.8	57.6	57.2	46.3	36.9	29.3	23.8	19.1	15.9				
6.0	47.4	47.4	47.4	47.9	47.7	45.2	36.9	29.3	23.8	19.1	16.0	12.5			
7.0	40.0	40.0	40.0	40.4	40.2	39.9	34.6	29.3	23.8	19.1	16.0	12.5	10.3		
8.0	34.3	34.3	34.3	35.4	35.4	35.1	33.3	28.6	23.8	19.1	16.0	12.5	10.3	8.4	
9.0	29.7	29.7	29.8	30.8	30.8	30.3	28.2	26.8	23.7	19.1	16.0	12.5	10.3	8.4	7.3
10.0			26.7	27.1	27.1	26.0	25.8	24.2	22.4	19.1	16.0	12.5	10.3	8.4	7.3
11.0			23.7	24.1	24.0	23.2	22.6	21.8	20.5	18.8	16.0	12.5	10.3	8.4	7.3
12.0			20.6	21.1	21.1	21.2	20.0	19.3	18.2	17.3	15.9	12.5	10.3	8.4	7.3
14.0				16.0	16.9	16.7	16.1	15.8	14.8	14.7	13.9	12.5	10.3	8.4	7.3
16.0				13.3	13.4	13.3	13.0	13.1	13.0	12.5	11.8	11.2	10.3	8.4	7.3
18.0					10.9	10.8	10.6	11.0	11.0	10.5	10.6	10.0	9.2	8.4	7.3
20.0					9.1	9.0	9.3	9.1	9.1	9.4	9.1	8.6	8.1	7.4	7.2
22.0						7.5	7.8	7.6	7.6	8.0	7.8	7.3	6.9	6.3	6.1
24.0							6.6	7.0	6.4	6.8	6.6	6.3	5.9	5.3	5.2
26.0							5.7	6.0	5.5	5.8	5.7	5.3	5.1	4.5	4.4
28.0								5.2	4.7	5.0	4.9	4.5	4.3	3.8	3.7
30.0								4.6	4.0	4.3	4.2	3.8	3.6	3.2	3.1
32.0									3.4	3.7	3.6	3.3	3.0	2.6	2.6
34.0									2.9	3.2	3.1	2.7	2.5	2.1	2.1
36.0										2.8	2.6	2.3	2.1	1.7	1.6
38.0										2.4	2.2	1.9	1.7	1.3	1.3
40.0											1.9	1.6	1.3	0.9	0.9
42.0											1.6	1.3	1.0	0.6	0.6
44.0												1.0	0.7		
46.0												0.8	0.5		

* Over rear · Nach hinten · A l'arrière · Hacia atrás · Indietro · Hazað

** With additional lifting equipment · Mit Zusatzhubausrüstung · Avec équipement de levage supplémentaire

Con equipamiento de elevación adicional · Con attrezzaggio di sollevamento supplementare · С дополнительным подъемным оборудованием



 m	11.4 m*	11.4 m	15.1 m	18.8 m	22.6 m	26.3 m	30.0 m	33.7 m	37.4 m	41.2 m	44.9 m	48.6 m	52.3 m	56.0 m	60.0 m
2.5	115.1**	111.5**	63.5	63.5	59.7	46.3	36.9								
3.0	97.1	97.1	63.5	63.5	59.7	46.3	36.9	29.3							
3.5	82.9	82.9	63.5	63.5	59.7	46.3	36.9	29.3	23.7						
4.0	72.2	72.2	63.5	63.5	59.6	46.3	36.9	29.3	23.8						
4.5	63.7	63.7	63.3	63.0	59.6	46.3	36.9	29.3	23.8	19.1					
5.0	57.0	57.0	57.0	56.9	56.4	46.3	36.9	29.3	23.8	19.1	15.9				
6.0	46.8	46.8	46.8	47.2	47.0	45.2	36.9	29.3	23.8	19.1	16.0	12.5			
7.0	39.4	39.4	39.4	39.9	39.7	39.7	34.6	29.3	23.8	19.1	16.0	12.5	10.3		
8.0	33.7	33.7	33.7	34.8	34.8	34.1	31.6	28.6	23.8	19.1	16.0	12.5	10.3	8.4	
9.0	29.2	29.2	29.8	30.2	30.2	28.7	27.7	26.3	23.6	19.1	16.0	12.5	10.3	8.4	7.3
10.0			26.2	26.6	26.2	24.7	24.5	23.4	21.7	19.1	16.0	12.5	10.3	8.4	7.3
11.0			22.9	23.5	22.8	22.7	21.4	20.6	19.4	18.1	16.0	12.5	10.3	8.4	7.3
12.0			19.5	20.0	20.0	20.1	19.0	18.2	17.2	16.4	15.2	12.5	10.3	8.4	7.3
14.0				15.7	16.0	15.8	15.2	14.9	14.7	14.2	13.1	12.2	10.3	8.4	7.3
16.0				12.5	12.7	12.6	12.2	12.6	12.3	11.8	11.4	10.5	9.8	8.4	7.3
18.0					10.3	10.2	10.5	10.3	10.3	10.2	10.0	9.4	8.9	8.2	7.3
20.0					8.5	8.4	8.7	8.5	8.5	8.9	8.5	8.0	7.5	6.9	6.7
22.0						7.0	7.3	7.5	7.1	7.5	7.3	6.8	6.4	5.8	5.6
24.0							6.2	6.5	6.0	6.3	6.2	5.8	5.4	4.9	4.7
26.0							5.3	5.6	5.0	5.4	5.2	4.9	4.6	4.1	4.0
28.0								4.9	4.3	4.6	4.5	4.1	3.9	3.4	3.3
30.0								4.2	3.6	4.0	3.8	3.5	3.2	2.8	2.7
32.0									3.1	3.4	3.2	2.9	2.7	2.3	2.2
34.0									2.6	2.9	2.8	2.4	2.2	1.8	1.8
36.0										2.5	2.3	2.0	1.8	1.4	1.4
38.0										2.1	2.0	1.6	1.4	1.0	1.0
40.0											1.6	1.3	1.1	0.7	0.7
42.0											1.4	1.0	0.8		
44.0												0.8	0.5		
46.0												0.6			



 m	11.4 m*	11.4 m	15.1 m	18.8 m	22.6 m	26.3 m	30.0 m	33.7 m	37.4 m	41.2 m	44.9 m	48.6 m	52.3 m	56.0 m	60.0 m
2.5	114.4**	111.3**	63.5	63.5	59.7	46.3	36.9								
3.0	95.8	95.8	63.5	63.5	59.7	46.3	36.9	29.3							
3.5	81.8	81.8	63.5	63.5	59.7	46.3	36.9	29.3	23.7						
4.0	71.2	71.2	63.5	63.5	59.6	46.3	36.9	29.3	23.8						
4.5	62.9	62.9	62.5	62.1	59.6	46.3	36.9	29.3	23.8	19.1					
5.0	56.2	56.2	56.2	56.1	55.6	46.3	36.9	29.3	23.8	19.1	15.9				
6.0	46.1	46.1	46.1	46.6	46.4	45.2	36.9	29.3	23.8	19.1	16.0	12.5			
7.0	38.8	38.8	38.9	39.7	39.7	39.1	34.4	29.3	23.8	19.1	16.0	12.5	10.3		
8.0	33.1	33.1	33.0	34.2	34.2	32.3	30.1	27.7	23.8	19.1	16.0	12.5	10.3	8.4	
9.0	28.6	28.6	29.3	29.7	29.0	27.2	26.8	25.1	22.7	19.1	16.0	12.5	10.3	8.4	7.3
10.0			25.7	26.1	24.8	24.6	23.1	22.2	20.6	19.0	16.0	12.5	10.3	8.4	7.3
11.0			21.6	22.2	21.5	21.5	20.3	19.4	18.3	17.3	15.9	12.5	10.3	8.4	7.3
12.0			18.7	18.9	19.8	18.9	17.9	17.5	16.4	15.8	14.6	12.5	10.3	8.4	7.3
14.0				14.9	15.1	14.9	14.3	14.0	14.0	13.4	12.5	11.4	10.3	8.4	7.3
16.0				11.7	11.9	11.8	11.6	11.9	11.5	11.1	11.1	10.0	9.2	8.4	7.3
18.0					9.6	9.5	9.9	9.7	9.6	9.8	9.4	8.8	8.3	7.6	7.3
20.0					8.0	7.8	8.1	8.1	7.9	8.3	8.0	7.4	6.9	6.3	6.1
22.0						6.5	6.8	7.2	6.6	7.0	6.8	6.3	5.9	5.3	5.1
24.0							5.7	6.1	5.5	5.9	5.7	5.4	5.0	4.4	4.3
26.0							4.8	5.2	4.6	5.0	4.8	4.5	4.2	3.7	3.5
28.0								4.5	3.9	4.2	4.1	3.8	3.5	3.0	2.9
30.0								3.9	3.3	3.6	3.5	3.1	2.9	2.5	2.4
32.0									2.7	3.1	2.9	2.6	2.3	2.0	1.9
34.0									2.3	2.6	2.4	2.1	1.9	1.5	1.5
36.0										2.2	2.0	1.7	1.5	1.1	1.1
38.0										1.9	1.7	1.4	1.1	0.7	0.7
40.0											1.4	1.1	0.8		
42.0											1.1	0.8	0.5		
44.0												0.5			

* Over rear · Nach hinten · A l'arrière · Hacia atrás · Indietro · Назад

** With additional lifting equipment · Mit Zusatzhubausrüstung · Avec équipement de levage supplémentaire

Con equipamiento de elevación adicional · Con attrezzaggio di sollevamento supplementare · С дополнительным подъемным оборудованием

Operation · Einsatz · Utilisation
 Uso · Эксплуатация



 m	11.4 m*	11.4 m	15.1 m	18.8 m	22.6 m	26.3 m	30.0 m	33.7 m	37.4 m	41.2 m	44.9 m	48.6 m	52.3 m	56.0 m	60.0 m
2.5	114.0**	111.2**	63.5	63.5	59.7	46.3	36.9								
3.0	95.3	95.3	63.5	63.5	59.7	46.3	36.9	29.3							
3.5	81.4	81.4	63.5	63.5	59.7	46.3	36.9	29.3	23.7						
4.0	70.8	70.8	63.5	63.5	59.6	46.3	36.9	29.3	23.8						
4.5	62.6	62.6	62.1	61.8	59.6	46.3	36.9	29.3	23.8	19.1					
5.0	55.9	55.9	55.9	55.8	55.5	46.3	36.9	29.3	23.8	19.1	15.9				
6.0	45.9	45.9	45.9	46.3	46.1	44.8	36.9	29.3	23.8	19.1	16.0	12.5			
7.0	38.6	38.6	38.6	39.7	39.7	38.5	34.4	29.3	23.8	19.1	16.0	12.5	10.3		
8.0	32.8	32.8	32.8	34.0	33.9	31.7	29.5	27.7	23.8	19.1	16.0	12.5	10.3	8.4	
9.0	28.4	28.4	29.1	29.5	28.4	26.6	26.3	24.6	22.6	19.1	16.0	12.5	10.3	8.4	7.3
10.0			25.4	25.5	24.3	24.1	22.7	21.7	20.4	18.6	16.0	12.5	10.3	8.4	7.3
11.0			21.2	21.7	21.3	21.0	19.9	19.0	17.9	16.9	15.7	12.5	10.3	8.4	7.3
12.0			18.3	18.5	19.4	18.5	17.5	17.1	16.4	15.8	14.6	12.5	10.3	8.4	7.3
14.0				14.5	14.7	14.6	14.0	13.9	13.6	13.1	12.4	11.3	10.3	8.4	7.3
16.0				11.5	11.6	11.5	11.6	11.6	11.2	11.1	10.9	10.0	9.2	8.4	7.3
18.0					9.4	9.3	9.6	9.4	9.4	9.5	9.1	8.5	8.0	7.4	7.1
20.0					7.9	7.6	7.9	8.1	7.7	8.1	7.8	7.2	6.7	6.1	5.9
22.0						6.3	6.6	7.0	6.4	6.8	6.6	6.1	5.7	5.1	4.9
24.0							5.5	5.9	5.3	5.7	5.6	5.2	4.8	4.2	4.1
26.0							4.7	5.1	4.5	4.8	4.7	4.4	4.0	3.5	3.4
28.0								4.3	3.7	4.1	3.9	3.6	3.4	2.9	2.8
30.0								3.7	3.1	3.5	3.3	3.0	2.8	2.3	2.2
32.0									2.6	2.9	2.8	2.5	2.2	1.8	1.8
34.0									2.2	2.5	2.3	2.0	1.8	1.4	1.4
36.0										2.1	1.9	1.6	1.4	1.0	1.0
38.0										1.8	1.6	1.3	1.0	0.6	0.6
40.0											1.3	1.0	0.7		
42.0												1.0	0.7		
44.0													0.5		



 m	11.4 m*	11.4 m	15.1 m	18.8 m	22.6 m	26.3 m	30.0 m	33.7 m	37.4 m	41.2 m	44.9 m	48.6 m	52.3 m	56.0 m	60.0 m
2.5	112.6**	110.9**	63.5	63.5	59.7	46.3	36.9								
3.0	94.0	94.0	63.5	63.5	59.7	46.3	36.9	29.3							
3.5	80.3	80.3	63.5	63.5	59.7	46.3	36.9	29.3	23.7						
4.0	69.8	69.8	63.5	63.5	59.6	46.3	36.9	29.3	23.8						
4.5	61.7	61.7	61.3	60.9	59.6	46.3	36.9	29.3	23.8	19.1					
5.0	55.1	55.1	55.2	55.5	55.4	46.3	36.9	29.3	23.8	19.1	15.9				
6.0	45.2	45.2	45.2	45.7	45.5	43.5	36.9	29.3	23.8	19.1	16.0	12.5			
7.0	37.9	37.9	37.9	39.1	39.1	36.5	33.5	29.3	23.8	19.1	16.0	12.5	10.3		
8.0	32.2	32.2	32.3	33.3	32.1	29.9	27.8	26.3	23.7	19.1	16.0	12.5	10.3	8.4	
9.0	27.9	27.9	28.6	28.3	26.8	26.3	24.8	23.7	21.8	19.1	16.0	12.5	10.3	8.4	7.3
10.0			23.9	24.0	22.8	22.7	21.4	20.4	19.2	18.1	16.0	12.5	10.3	8.4	7.3
11.0			19.9	20.4	20.8	19.8	18.7	18.2	17.3	16.3	14.7	12.5	10.3	8.4	7.3
12.0			17.2	17.6	18.3	17.4	16.4	16.1	15.9	15.0	14.0	12.5	10.3	8.4	7.3
14.0				13.6	13.8	13.7	13.1	13.2	12.8	12.3	11.5	10.9	10.0	8.4	7.3
16.0				10.7	10.9	10.8	11.1	10.8	10.5	10.6	10.2	9.5	8.9	8.2	7.3
18.0					8.7	8.6	9.0	8.9	8.7	8.9	8.5	7.9	7.4	6.7	6.5
20.0					7.6	7.0	7.3	7.8	7.2	7.5	7.2	6.6	6.2	5.6	5.4
22.0						5.9	6.1	6.5	5.9	6.3	6.1	5.6	5.2	4.6	4.4
24.0							5.1	5.5	4.9	5.2	5.1	4.7	4.3	3.8	3.6
26.0							4.3	4.6	4.0	4.4	4.3	3.9	3.6	3.1	3.0
28.0								3.9	3.4	3.7	3.6	3.2	3.0	2.5	2.4
30.0								3.4	2.8	3.1	3.0	2.7	2.4	2.0	1.9
32.0									2.3	2.6	2.5	2.1	1.9	1.5	1.4
34.0									1.9	2.2	2.0	1.7	1.5	1.1	1.0
36.0										1.8	1.7	1.3	1.1	0.7	0.7
38.0										1.5	1.3	1.0	0.8		
40.0											1.0	0.7	0.5		
42.0												0.8	0.5		

* Over rear · Nach hinten · A l'arrière · Hacia atrás · Indietro · Hazað

** With additional lifting equipment · Mit Zusatzhubausrüstung · Avec équipement de levage supplémentaire

Con equipamiento de elevación adicional · Con attrezzaggio di sollevamento supplementare · С дополнительным подъемным оборудованием

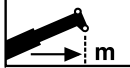

 m	11.4 m*	11.4 m	15.1 m	18.8 m	22.6 m	26.3 m	30.0 m	33.7 m	37.4 m	41.2 m	44.9 m	48.6 m	52.3 m	56.0 m	60.0 m
2.5	111.2**	110.6**	63.5	63.5	59.7	46.3	36.9								
3.0	92.7	92.7	63.5	63.5	59.7	46.3	36.9	29.3							
3.5	79.2	79.2	63.5	63.5	59.7	46.3	36.9	29.3	23.7						
4.0	68.9	68.9	63.5	63.5	59.6	46.3	36.9	29.3	23.8						
4.5	60.8	60.8	60.4	60.1	59.6	46.3	36.9	29.3	23.8	19.1					
5.0	54.3	54.3	54.4	54.8	54.6	46.3	36.9	29.3	23.8	19.1	15.9				
6.0	44.5	44.5	44.6	45.0	44.8	41.4	36.8	29.3	23.8	19.1	16.0	12.5			
7.0	37.2	37.2	37.2	38.4	37.1	34.4	31.8	28.6	23.8	19.1	16.0	12.5	10.3		
8.0	31.6	31.6	32.3	32.0	30.2	28.1	27.6	25.5	22.7	19.1	16.0	12.5	10.3	8.4	
9.0	27.1	26.6	27.7	26.6	25.2	24.9	23.4	22.2	20.6	18.9	16.0	12.5	10.3	8.4	7.3
10.0			22.4	22.5	22.5	21.3	20.1	19.5	18.4	16.9	15.6	12.5	10.3	8.4	7.3
11.0			19.0	19.2	19.5	18.6	17.5	17.0	16.8	15.6	14.4	12.5	10.3	8.4	7.3
12.0			16.1	16.9	17.1	16.4	15.4	15.4	14.9	14.2	13.0	12.0	10.3	8.4	7.3
14.0				12.7	12.9	12.8	12.8	12.3	11.9	12.0	11.4	10.0	9.2	8.4	7.3
16.0				9.9	10.1	10.0	10.4	10.0	9.7	9.9	9.4	8.8	8.2	7.5	7.3
18.0					8.5	8.0	8.3	8.7	8.0	8.2	7.8	7.3	6.8	6.1	5.9
20.0					7.1	6.5	6.8	7.2	6.6	6.9	6.6	6.0	5.6	5.0	4.8
22.0						5.9	5.6	6.0	5.4	5.8	5.6	5.1	4.6	4.1	3.9
24.0							4.6	5.0	4.4	4.8	4.6	4.2	3.8	3.3	3.2
26.0							3.9	4.2	3.6	4.0	3.8	3.5	3.2	2.6	2.5
28.0								3.6	3.0	3.3	3.2	2.9	2.6	2.1	2.0
30.0								3.0	2.4	2.8	2.6	2.3	2.0	1.6	1.5
32.0									2.0	2.3	2.1	1.8	1.6	1.1	1.1
34.0									1.6	1.9	1.7	1.4	1.2	0.8	0.7
36.0										1.5	1.4	1.0	0.8		
38.0										1.2	1.0	0.7	0.5		
40.0											0.8	0.5			
42.0											0.5				

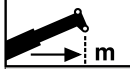

 m	11.4 m*	11.4 m	15.1 m	18.8 m	22.6 m	26.3 m	30.0 m	33.7 m	37.4 m	41.2 m	44.9 m	48.6 m	52.3 m	56.0 m	60.0 m
2.5	109.8**	109.8**	63.5	63.5	59.7	46.3	36.9								
3.0	91.4	91.4	63.5	63.5	59.7	46.3	36.9	29.3							
3.5	78.0	78.0	63.5	63.5	59.7	46.3	36.9	29.3	23.7						
4.0	67.9	67.9	63.5	63.5	59.6	46.3	36.9	29.3	23.8						
4.5	59.9	59.9	59.5	59.5	59.3	46.3	36.9	29.3	23.8	19.1					
5.0	53.5	53.5	53.6	54.1	53.8	46.3	36.9	29.3	23.8	19.1	15.9				
6.0	43.9	43.9	43.9	44.4	42.8	39.7	35.1	29.3	23.8	19.1	16.0	12.5			
7.0	36.5	36.5	36.5	37.4	34.9	32.2	29.7	27.6	23.8	19.1	16.0	12.5	10.3		
8.0	31.0	31.0	31.5	30.0	28.3	27.7	25.9	24.5	21.9	19.1	16.0	12.5	10.3	8.4	
9.0	25.6	24.8	25.8	24.9	24.3	23.3	21.9	21.2	19.4	18.1	16.0	12.5	10.3	8.4	7.3
10.0			20.9	21.0	21.1	20.0	18.8	18.2	17.8	16.3	14.6	12.5	10.3	8.4	7.3
11.0			17.7	18.6	18.2	17.4	16.3	16.3	15.7	15.0	13.6	12.4	10.3	8.4	7.3
12.0			14.9	15.8	16.0	15.3	14.4	14.4	13.8	13.2	12.4	11.3	10.3	8.4	7.3
14.0				11.8	12.0	11.9	12.0	11.4	11.0	11.1	10.6	9.9	9.2	8.4	7.3
16.0				9.2	9.4	9.2	9.6	9.8	9.0	9.1	8.7	8.1	7.5	6.8	6.6
18.0					7.9	7.3	7.7	8.1	7.4	7.6	7.2	6.6	6.1	5.5	5.3
20.0					6.5	6.5	6.2	6.6	6.0	6.3	6.0	5.5	5.0	4.4	4.3
22.0						5.4	5.1	5.5	4.9	5.2	5.0	4.5	4.1	3.6	3.4
24.0							4.2	4.5	4.0	4.3	4.2	3.8	3.4	2.8	2.7
26.0								3.4	3.8	3.2	3.4	3.1	2.7	2.2	2.1
28.0									3.2	2.6	2.9	2.8	2.5	2.2	1.6
30.0									2.7	2.1	2.4	2.3	1.9	1.7	1.1
32.0										1.6	2.0	1.8	1.5	1.2	0.8
34.0										1.3	1.6	1.4	1.1	0.8	0.7
36.0											1.2	1.1	0.8	0.5	
38.0											0.9	0.8	0.5		
40.0												0.5			

* Over rear · Nach hinten · A l'arrière · Hacia atrás · Indietro · Назад

** With additional lifting equipment · Mit Zusatzhubausrüstung · Avec équipement de levage supplémentaire

Con equipamiento de elevación adicional · Con attrezzaggio di sollevamento supplementare · С дополнительным подъемным оборудованием

Operation · Einsatz · Utilisation
 Uso · Эксплуатация



Reach (m)	11.4 m*	11.4 m	15.1 m	18.8 m	22.6 m	26.3 m	30.0 m	33.7 m	37.4 m	41.2 m	44.9 m	48.6 m	52.3 m	56.0 m	60.0 m
2.5	109.0**	109.0**	63.5	63.5	59.7	46.3	36.9								
3.0	90.7	90.7	63.5	63.5	59.7	46.3	36.9	29.3							
3.5	77.4	77.4	63.5	63.5	59.7	46.3	36.9	29.3	23.7						
4.0	67.3	67.3	63.5	63.5	59.6	46.3	36.9	29.3	23.8						
4.5	59.4	59.4	59.5	59.3	58.8	46.3	36.9	29.3	23.8	19.1					
5.0	53.1	53.1	53.1	53.6	53.4	46.3	36.9	29.3	23.8	19.1	15.9				
6.0	43.4	43.4	43.5	44.0	41.2	39.4	34.4	29.3	23.8	19.1	16.0	12.5			
7.0	36.0	36.0	36.1	36.0	33.5	31.0	28.5	26.5	23.8	19.1	16.0	12.5	10.3		
8.0	30.6	30.6	30.2	28.9	27.2	26.7	24.9	23.6	21.5	19.1	16.0	12.5	10.3	8.4	
9.0	24.7	23.7	24.8	23.9	23.7	22.4	21.0	20.3	18.6	17.4	15.9	12.5	10.3	8.4	7.3
10.0			20.5	20.2	20.2	19.1	18.0	17.5	17.2	15.8	14.6	12.5	10.3	8.4	7.3
11.0			17.0	17.8	17.5	16.7	15.6	15.6	15.0	14.3	13.0	12.0	10.3	8.4	7.3
12.0			14.3	15.1	15.3	14.6	14.4	13.7	13.2	12.9	11.8	11.1	10.2	8.4	7.3
14.0				11.3	11.5	11.4	11.5	10.9	10.5	10.6	10.1	9.4	8.8	8.1	7.3
16.0				8.7	9.4	8.8	9.2	9.5	8.5	8.7	8.3	7.6	7.1	6.4	6.2
18.0					7.5	7.1	7.3	7.7	7.0	7.2	6.8	6.3	5.8	5.2	5.0
20.0					6.1	6.1	5.9	6.3	5.7	6.0	5.7	5.1	4.7	4.1	4.0
22.0						5.1	4.8	5.2	4.6	4.9	4.7	4.2	3.8	3.3	3.1
24.0							3.9	4.3	3.7	4.1	3.9	3.5	3.1	2.5	2.4
26.0							3.2	3.5	3.0	3.3	3.2	2.8	2.5	1.9	1.8
28.0								2.9	2.4	2.7	2.6	2.2	1.9	1.4	1.3
30.0								2.5	1.9	2.2	2.0	1.7	1.5	1.0	0.9
32.0									1.4	1.8	1.6	1.3	1.0	0.6	0.5
34.0									1.1	1.4	1.2	0.9	0.7		
36.0										1.1	0.9	0.6			
38.0										0.8	0.6				



Reach (m)	11.4 m*	11.4 m	15.1 m	18.8 m	22.6 m	26.3 m	30.0 m	33.7 m	37.4 m	41.2 m	44.9 m	48.6 m	52.3 m	56.0 m	60.0 m
2.5	107.5**	107.5**	63.5	63.5	59.7	46.3	36.9								
3.0	89.4	89.4	63.5	63.5	59.7	46.3	36.9	29.3							
3.5	76.3	76.3	63.5	63.5	59.7	46.3	36.9	29.3	23.7						
4.0	66.3	66.3	63.5	63.5	59.6	46.3	36.9	29.3	23.8						
4.5	58.5	58.5	58.6	58.4	58.0	46.3	36.9	29.3	23.8	19.1					
5.0	52.3	52.3	52.3	52.8	51.7	45.2	36.9	29.3	23.8	19.1	15.9				
6.0	42.6	42.6	42.6	42.3	39.7	36.8	33.3	28.8	23.8	19.1	16.0	12.5			
7.0	35.3	35.3	35.2	33.6	31.3	28.8	27.7	25.8	22.7	19.1	16.0	12.5	10.3		
8.0	29.3	28.5	28.1	26.9	26.3	24.9	23.2	22.3	20.3	18.3	16.0	12.5	10.3	8.4	
9.0	23.2	21.9	23.0	22.2	22.1	20.8	19.5	18.9	18.3	16.4	14.8	12.5	10.3	8.4	7.3
10.0			19.0	19.5	18.8	17.8	16.6	16.6	15.9	15.0	13.7	12.4	10.3	8.4	7.3
11.0			15.7	16.5	16.2	15.4	15.2	14.4	13.9	13.2	12.4	11.3	10.3	8.4	7.3
12.0			13.1	14.0	14.1	13.5	13.4	12.7	12.2	12.3	11.4	10.2	9.3	8.4	7.3
14.0				10.4	10.6	10.5	10.6	10.7	9.6	9.8	9.3	8.6	8.0	7.3	7.0
16.0				7.9	8.6	8.0	8.4	8.7	7.7	7.9	7.5	6.9	6.4	5.7	5.5
18.0					6.8	6.9	6.6	7.1	6.3	6.5	6.2	5.6	5.1	4.5	4.4
20.0					5.6	5.6	5.3	5.7	5.1	5.4	5.1	4.6	4.1	3.6	3.4
22.0						4.6	4.2	4.6	4.1	4.4	4.2	3.7	3.3	2.7	2.6
24.0							3.4	3.8	3.2	3.6	3.4	3.0	2.6	2.1	2.0
26.0							2.8	3.1	2.5	2.9	2.8	2.4	2.0	1.5	1.4
28.0								2.6	2.0	2.3	2.2	1.9	1.5	1.0	0.9
30.0								2.1	1.5	1.8	1.7	1.4	1.1	0.6	0.5
32.0									1.1	1.4	1.3	1.0	0.7		
34.0									0.8	1.1	0.9	0.6			
36.0										0.8	0.6				
38.0											0.5				

* Over rear · Nach hinten · A l'arrière · Hacia atrás · Indietro · Hazað

** With additional lifting equipment · Mit Zusatzhubausrüstung · Avec équipement de levage supplémentaire

Con equipamiento de elevación adicional · Con attrezzaggio di sollevamento supplementare · С дополнительным подъемным оборудованием



→ m	11.4 m*	11.4 m	15.1 m	18.8 m	22.6 m	26.3 m	30.0 m	33.7 m	37.4 m	41.2 m	44.9 m	48.6 m	52.3 m	56.0 m	60.0 m
2.5	105.9**	105.9**	63.5	63.5	59.7	46.3	36.9								
3.0	88.0	88.0	63.5	63.5	59.7	46.3	36.9	29.3							
3.5	75.1	75.1	63.5	63.5	59.7	46.3	36.9	29.3	23.7						
4.0	65.3	65.3	63.5	63.5	59.6	46.3	36.9	29.3	23.8						
4.5	57.6	57.6	57.7	57.5	55.5	46.3	36.9	29.3	23.8	19.1					
5.0	51.5	51.5	51.5	52.0	48.6	43.3	36.9	29.3	23.8	19.1	15.9				
6.0	41.7	41.7	41.7	39.7	37.2	33.9	30.9	27.7	23.8	19.1	16.0	12.5			
7.0	34.6	34.6	32.7	30.9	28.8	27.7	26.1	24.4	21.9	19.1	16.0	12.5	10.3		
8.0	27.3	26.1	25.8	24.7	24.4	22.9	21.3	20.5	18.6	17.4	15.9	12.5	10.3	8.4	
9.0	21.6	20.0	21.5	21.2	20.3	19.2	17.9	17.7	16.9	15.6	14.2	12.5	10.3	8.4	7.3
10.0			17.4	17.8	17.2	16.3	16.1	15.2	14.6	13.8	12.5	11.4	10.3	8.4	7.3
11.0			14.3	15.2	14.8	14.1	13.9	13.2	12.7	12.7	11.4	10.5	9.5	8.4	7.3
12.0			11.9	12.8	12.9	12.3	12.2	12.3	11.1	11.2	10.6	9.9	9.2	8.4	7.3
14.0				9.4	10.1	9.5	9.6	9.7	8.7	8.8	8.4	7.7	7.2	6.5	6.2
16.0				7.1	7.8	7.8	7.6	7.9	6.9	7.1	6.7	6.2	5.7	5.0	4.8
18.0					6.1	6.2	5.9	6.3	5.6	5.8	5.5	4.9	4.5	3.9	3.7
20.0					4.9	4.9	4.7	5.1	4.5	4.7	4.4	3.9	3.5	2.9	2.8
22.0						4.0	3.7	4.1	3.5	3.9	3.6	3.1	2.7	2.2	2.1
24.0							2.9	3.3	2.7	3.1	2.9	2.5	2.1	1.6	1.4
26.0							2.3	2.7	2.1	2.4	2.3	1.9	1.5	1.0	0.9
28.0								2.1	1.6	1.9	1.8	1.4	1.0	0.5	
30.0								1.7	1.1	1.5	1.3	1.0	0.6		
32.0									0.7	1.1	0.9	0.6			
34.0										0.7	0.6				



→ m	11.4 m*	11.4 m	15.1 m	18.8 m	22.6 m	26.3 m	30.0 m	33.7 m	37.4 m	41.2 m	44.9 m	48.6 m	52.3 m	56.0 m	60.0 m
2.5	104.5**	104.5**	63.5	63.5	59.7	46.3	36.9								
3.0	86.9	86.9	63.5	63.5	59.7	46.3	36.9	29.3							
3.5	74.1	74.1	63.5	63.5	59.7	46.3	36.9	29.3	23.7						
4.0	64.4	64.4	63.5	63.5	59.6	46.3	36.9	29.3	23.8						
4.5	56.9	56.9	56.9	56.9	54.8	46.2	36.9	29.3	23.8	19.1					
5.0	50.8	50.8	50.8	51.3	46.1	40.8	36.1	29.3	23.8	19.1	15.9				
6.0	41.0	41.0	39.3	38.2	35.1	31.9	29.9	26.6	23.7	19.1	16.0	12.5			
7.0	34.0	32.5	30.7	29.1	27.7	26.5	24.5	23.0	20.7	18.8	16.0	12.5	10.3		
8.0	26.0	24.4	24.2	23.6	23.0	21.6	20.0	19.7	18.5	16.4	14.8	12.5	10.3	8.4	
9.0	20.5	18.6	20.1	19.9	19.1	18.0	17.5	16.6	15.9	15.0	13.5	12.3	10.3	8.4	7.3
10.0			16.2	16.7	16.1	15.3	15.1	14.2	13.6	12.9	12.0	11.2	10.2	8.4	7.3
11.0			13.3	14.2	13.9	13.2	13.0	13.1	11.8	11.8	11.2	10.0	9.2	8.4	7.3
12.0			11.0	11.9	12.0	11.4	11.4	11.5	10.3	10.4	9.9	9.1	8.5	7.7	7.3
14.0				8.7	9.4	8.9	8.9	9.1	8.0	8.2	7.8	7.1	6.6	5.9	5.6
16.0				6.5	7.2	7.3	7.0	7.3	6.4	6.6	6.2	5.6	5.1	4.5	4.3
18.0					5.6	5.7	5.4	5.8	5.1	5.3	5.0	4.4	4.0	3.4	3.2
20.0					4.5	4.5	4.2	4.6	4.0	4.3	4.0	3.5	3.1	2.5	2.4
22.0						3.6	3.3	3.7	3.1	3.5	3.2	2.7	2.3	1.7	1.6
24.0							2.6	3.0	2.4	2.7	2.5	2.1	1.7	1.1	1.0
26.0							2.0	2.4	1.8	2.1	1.9	1.5	1.1	0.6	0.5
28.0								1.8	1.2	1.6	1.4	1.0	0.7		
30.0								1.4	0.8	1.1	1.0	0.6			
32.0										0.8	0.6				

* Over rear · Nach hinten · A l'arrière · Hacia atrás · Indietro · Назад

** With additional lifting equipment · Mit Zusatzhubausrüstung · Avec équipement de levage supplémentaire

Con equipamiento de elevación adicional · Con attrezzaggio di sollevamento supplementare · С дополнительным подъемным оборудованием

Operation · Einsatz · Utilisation
 Uso · Эксплуатация

Working range · Arbeitsbereich · Rayon de travail
 Zona de trabajo · Area di lavoro · Рабочая зона

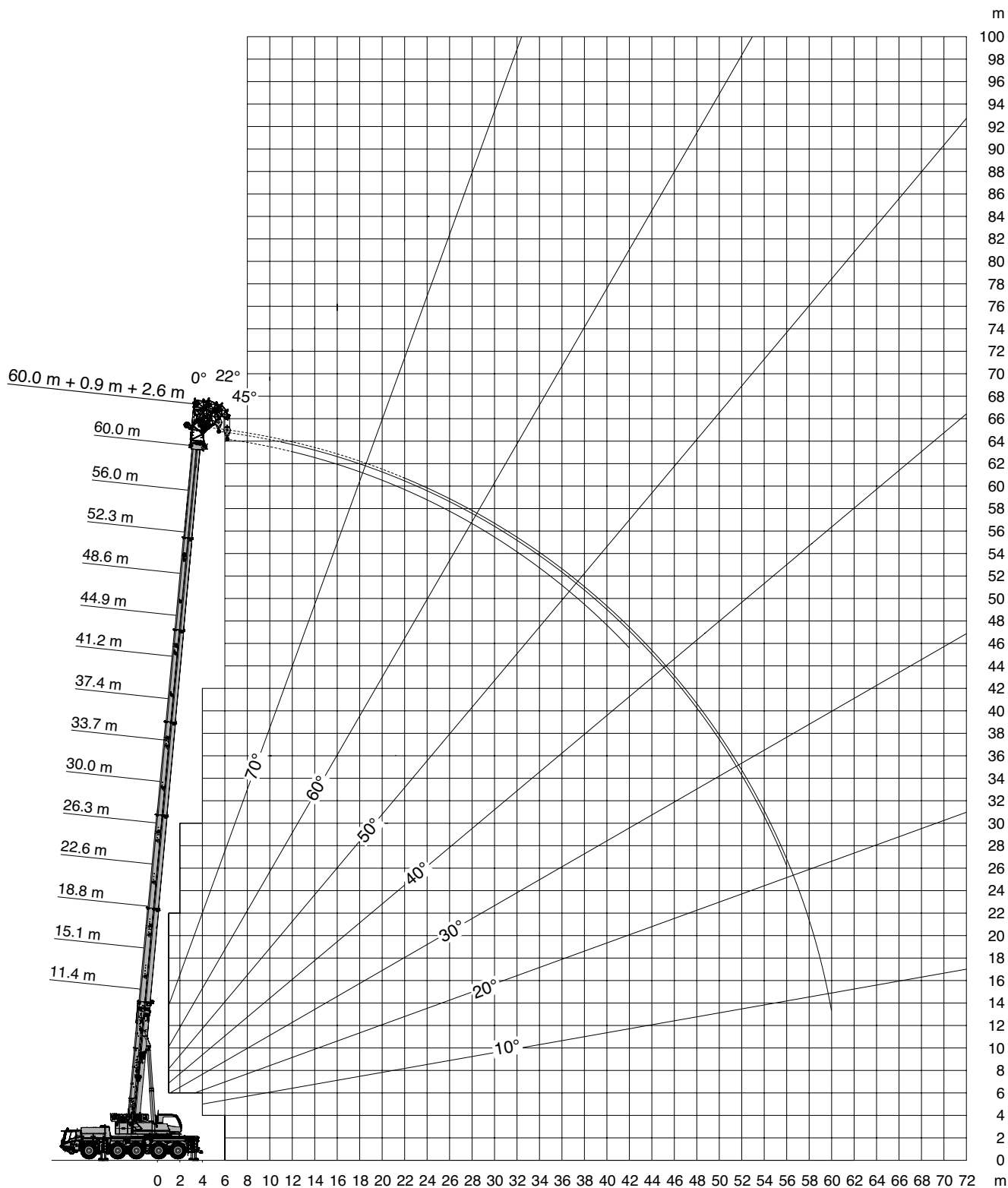
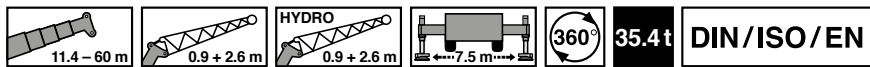

Lifting capacities · Traglasten · Charges de levage
Cargas · Portate · Грузоподъемность

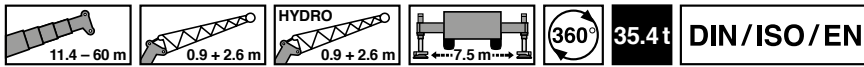

m	11.4 m + 0.9 m + 2.6 m			30.0 m + 0.9 m + 2.6 m			44.9 m + 0.9 m + 2.6 m			56.0 m + 0.9 m + 2.6 m			60.0 m + 0.9 m + 2.6 m		
	0°	22°	45°	0°	22°	45°	0°	22°	45°	0°	22°	45°	0°	22°	45°
3.0	36.3	35.3	25.7												
3.5	36.3	34.1	25.2			25.3									
4.0	36.3	32.9	24.8			29.1									
4.5	36.3	31.9	24.4			29.1	26.2								
5.0	36.3	30.9	24.1			29.1	26.0								
6.0	35.0	29.3	23.5			29.1	25.4								
7.0	31.9	27.9	23.2			29.1	24.9		11.0						
8.0	29.4	26.8	23.0	28.7	28.4	24.5		11.0	11.0						
9.0	27.3	25.6	23.0	26.6	26.3	24.1		11.0	11.0						
10.0	25.6	24.6		25.3	25.3	23.7		11.0	11.0		6.3	6.3			
11.0	24.3	23.9		25.3	25.3	23.1		11.0	11.0		6.3	6.3		5.5	
12.0	23.2	23.7		25.3	25.3	22.8		11.0	11.0		6.3	6.3		5.5	5.5
14.0				21.0	21.3	21.5		11.0	11.0		6.3	6.3		5.5	5.5
16.0				17.7	18.0	18.1	11.0	11.0	11.0		6.3	6.3		5.5	5.5
18.0				15.1	15.3	15.4	11.0	11.0	11.0		6.3	6.3		5.5	5.5
20.0				13.1	13.2	13.3	10.1	10.1	10.2	6.3	6.3	6.3		5.5	5.5
22.0				11.5	11.6	11.7	9.2	9.3	9.3	6.3	6.3	6.3	5.5	5.5	5.5
24.0				10.8	10.3		8.5	8.5	8.5	6.3	6.3	6.3	5.5	5.5	5.5
26.0				9.6	9.6		7.8	7.8	7.8	6.3	6.3	6.3	5.5	5.5	5.5
28.0				8.6	8.6		7.1	7.2	7.2	6.2	6.3	6.3	5.5	5.5	5.5
30.0				7.7			6.6	6.6	6.6	5.8	5.8	5.9	5.3	5.2	5.2
32.0							6.2	6.2	6.2	5.4	5.4	5.5	5.0	5.0	4.9
34.0							5.7	5.8		5.0	5.1	5.1	4.7	4.7	4.7
36.0							5.2	5.2		4.7	4.7	4.7	4.4	4.4	4.4
38.0							4.7	4.6		4.1	4.2	4.2	4.1	4.1	4.1
40.0							4.5	4.4		3.6	3.7	3.7	3.6	3.6	3.7
42.0							4.1	4.1		3.1	3.2		3.1	3.2	3.2
44.0							3.7			2.7	2.8		2.7	2.7	
46.0							3.3			2.3	2.4		2.3	2.3	
48.0										2.0	2.0		1.9	2.0	
50.0										1.7	1.7		1.6	1.7	
52.0										1.4	1.4		1.4	1.4	
54.0										1.2			1.1	1.1	
56.0										0.9			0.9	0.9	
58.0													0.6		
60.0													0.5		

Operation · Einsatz · Utilisation
 Uso · Эксплуатация

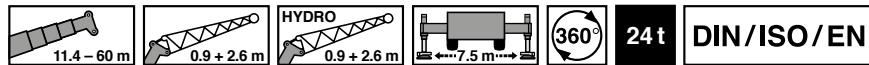

m	11.4 m + 0.9 m + 2.6 m			30.0 m + 0.9 m + 2.6 m			44.9 m + 0.9 m + 2.6 m			56.0 m + 0.9 m + 2.6 m			60.0 m + 0.9 m + 2.6 m		
	0°	22°	45°	0°	22°	45°	0°	22°	45°	0°	22°	45°	0°	22°	45°
3.0	36.3	35.3	25.7												
3.5	36.3	34.1	25.2		25.3										
4.0	36.3	32.9	24.8		29.1										
4.5	36.3	31.9	24.4		29.1	26.2									
5.0	36.3	30.9	24.1		29.1	26.0									
6.0	35.0	29.3	23.5		29.1	25.4									
7.0	31.9	27.9	23.2		29.1	24.9		11.0							
8.0	29.4	26.8	23.0	28.7	28.4	24.5		11.0	11.0						
9.0	27.3	25.6	23.0	26.6	26.3	24.1		11.0	11.0						
10.0	25.6	24.6		25.3	25.3	23.7		11.0	11.0		6.3	6.3			
11.0	24.3	23.9		25.3	25.3	23.1		11.0	11.0		6.3	6.3		5.5	
12.0	23.2	23.7		23.1	23.4	22.8		11.0	11.0		6.3	6.3		5.5	5.5
14.0				18.9	19.2	19.4		11.0	11.0		6.3	6.3		5.5	5.5
16.0				15.9	16.0	16.2	11.0	11.0	11.0		6.3	6.3		5.5	5.5
18.0				13.3	13.3	13.4	11.0	11.0	11.0		6.3	6.3		5.5	5.5
20.0				11.6	11.4	11.1	9.9	10.1	10.2	6.3	6.3	6.3		5.5	5.5
22.0				9.8	10.0	10.0	9.1	8.8	8.7	6.3	6.3	6.3	5.5	5.5	5.5
24.0				8.4	8.5		8.2	8.3	8.1	6.3	6.3	6.3	5.5	5.5	5.5
26.0				7.2	7.3		7.0	7.1	7.2	6.3	6.3	6.3	5.5	5.5	5.5
28.0				6.2	6.3		6.2	6.1	6.2	5.5	5.6	5.7	5.3	5.5	5.5
30.0				5.5			5.7	5.6	5.6	4.7	4.9	4.9	4.6	4.7	4.8
32.0							5.0	5.1	5.1	4.0	4.1	4.2	4.0	4.1	4.1
34.0							4.4	4.4		3.4	3.5	3.5	3.3	3.4	3.5
36.0							3.8	3.9		2.8	2.9	3.0	2.8	2.9	2.9
38.0							3.3	3.4		2.4	2.4	2.5	2.3	2.4	2.4
40.0							2.9	2.9		1.9	2.0	2.0	1.9	2.0	2.0
42.0							2.5	2.5		1.6	1.6		1.5	1.6	1.6
44.0							2.2			1.2	1.3		1.2	1.2	
46.0							1.9			0.9	1.0		0.9	0.9	
48.0										0.6	0.7		0.6	0.6	

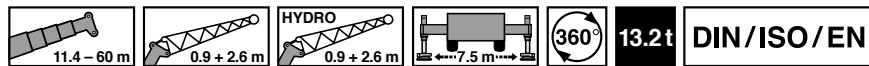

m	11.4 m + 0.9 m + 2.6 m			30.0 m + 0.9 m + 2.6 m			44.9 m + 0.9 m + 2.6 m			56.0 m + 0.9 m + 2.6 m			60.0 m + 0.9 m + 2.6 m		
	0°	22°	45°	0°	22°	45°	0°	22°	45°	0°	22°	45°	0°	22°	45°
3.0	36.3	35.3	25.7												
3.5	36.3	34.1	25.2		25.3										
4.0	36.3	32.9	24.8		29.1										
4.5	36.3	31.9	24.4		29.1	26.2									
5.0	36.3	30.9	24.1		29.1	26.0									
6.0	35.0	29.3	23.5		29.1	25.4									
7.0	31.9	27.9	23.2		29.1	24.9		11.0							
8.0	29.4	26.8	23.0	28.4	28.4	24.5		11.0	11.0						
9.0	27.3	25.6	23.0	25.3	25.3	24.1		11.0	11.0						
10.0	25.6	24.6		22.3	22.9	23.4		11.0	11.0		6.3	6.3			
11.0	23.7	23.8		19.6	20.1	20.5		11.0	11.0		6.3	6.3		5.5	
12.0	20.3	20.4		17.4	17.7	18.1		11.0	11.0		6.3	6.3		5.5	5.5
14.0				14.8	14.1	14.2		11.0	11.0		6.3	6.3		5.5	5.5
16.0				12.1	12.3	12.4	10.6	10.8	10.5		6.3	6.3		5.5	5.5
18.0				9.8	10.0	10.1	8.8	9.0	9.2		6.3	6.3		5.5	5.5
20.0				8.0	8.2	8.2	8.0	7.9	7.7	6.3	6.3	6.3		5.5	5.5
22.0				7.1	7.0	7.0	6.8	7.0	7.1	5.2	5.4	5.6	5.1	5.3	5.4
24.0				6.0	6.1		5.8	6.0	6.1	4.3	4.5	4.6	4.2	4.4	4.5
26.0				5.1	5.1		4.9	5.0	5.1	3.6	3.7	3.8	3.4	3.6	3.7
28.0				4.6	4.5		4.1	4.2	4.3	2.9	3.1	3.1	2.8	2.9	3.0
30.0				4.1			3.5	3.5	3.6	2.3	2.5	2.5	2.2	2.4	2.4
32.0							2.9	3.0	3.0	1.8	2.0	2.0	1.7	1.8	1.9
34.0							2.4	2.5		1.4	1.5	1.6	1.3	1.4	1.5
36.0							2.0	2.0		1.0	1.1	1.1	0.9	1.0	1.0
38.0							1.6	1.6		0.6	0.7	0.7	0.6	0.6	0.7
40.0							1.3	1.3							
42.0							1.0	1.0							
44.0							0.7								
46.0							0.5								

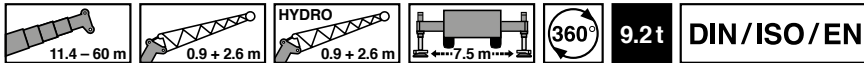

 m	11.4 m + 0.9 m + 2.6 m			30.0 m + 0.9 m + 2.6 m			44.9 m + 0.9 m + 2.6 m			56.0 m + 0.9 m + 2.6 m			60.0 m + 0.9 m + 2.6 m		
	0°	22°	45°	0°	22°	45°	0°	22°	45°	0°	22°	45°	0°	22°	45°
3.0	36.3	35.3	25.7												
3.5	36.3	34.1	25.2		25.3										
4.0	36.3	32.9	24.8		29.1										
4.5	36.3	31.9	24.4		29.1	26.2									
5.0	36.3	30.9	24.1		29.1	26.0									
6.0	35.0	29.3	23.5		29.1	25.4									
7.0	31.9	27.9	23.2		29.1	24.9		11.0							
8.0	29.4	26.8	23.0	25.3	25.4	24.5		11.0	11.0						
9.0	27.3	25.6	23.0	22.5	23.1	23.8		11.0	11.0						
10.0	24.9	24.6		19.4	20.0	20.5		11.0	11.0		6.3	6.3			
11.0	20.8	21.0		18.1	17.4	17.8		11.0	11.0		6.3	6.3		5.5	
12.0	17.6	17.7		15.9	15.3	15.6		11.0	11.0		6.3	6.3		5.5	5.5
14.0				12.7	13.0	13.1		11.0	11.0		6.3	6.3		5.5	5.5
16.0				10.3	10.5	10.7	8.9	9.1	9.3		6.3	6.3		5.5	5.5
18.0				8.6	8.5	8.6	7.9	8.1	8.1		6.3	6.3		5.5	5.5
20.0				7.2	7.4	7.4	6.6	6.8	7.0	5.0	5.2	5.4		5.1	5.2
22.0				5.9	6.0	6.1	5.6	5.7	5.8	4.1	4.3	4.4	3.9	4.1	4.2
24.0				5.3	5.2		4.7	4.8	4.9	3.3	3.4	3.5	3.1	3.3	3.4
26.0				4.6	4.6		3.9	4.0	4.1	2.6	2.7	2.8	2.4	2.6	2.7
28.0				3.9	3.9		3.2	3.3	3.4	2.0	2.1	2.2	1.9	2.0	2.1
30.0				3.3			2.6	2.7	2.7	1.5	1.6	1.7	1.4	1.5	1.6
32.0							2.1	2.2	2.2	1.0	1.1	1.2	0.9	1.0	1.1
34.0							1.7	1.7		0.6	0.7	0.8	0.5	0.6	0.7
36.0							1.3	1.3							
38.0							0.9	1.0							
40.0							0.7	0.7							

Operation · Einsatz · Utilisation
 Uso · Эксплуатация

Working range · Arbeitsbereich · Rayon de travail
 Zona de trabajo · Area di lavoro · Рабочая зона

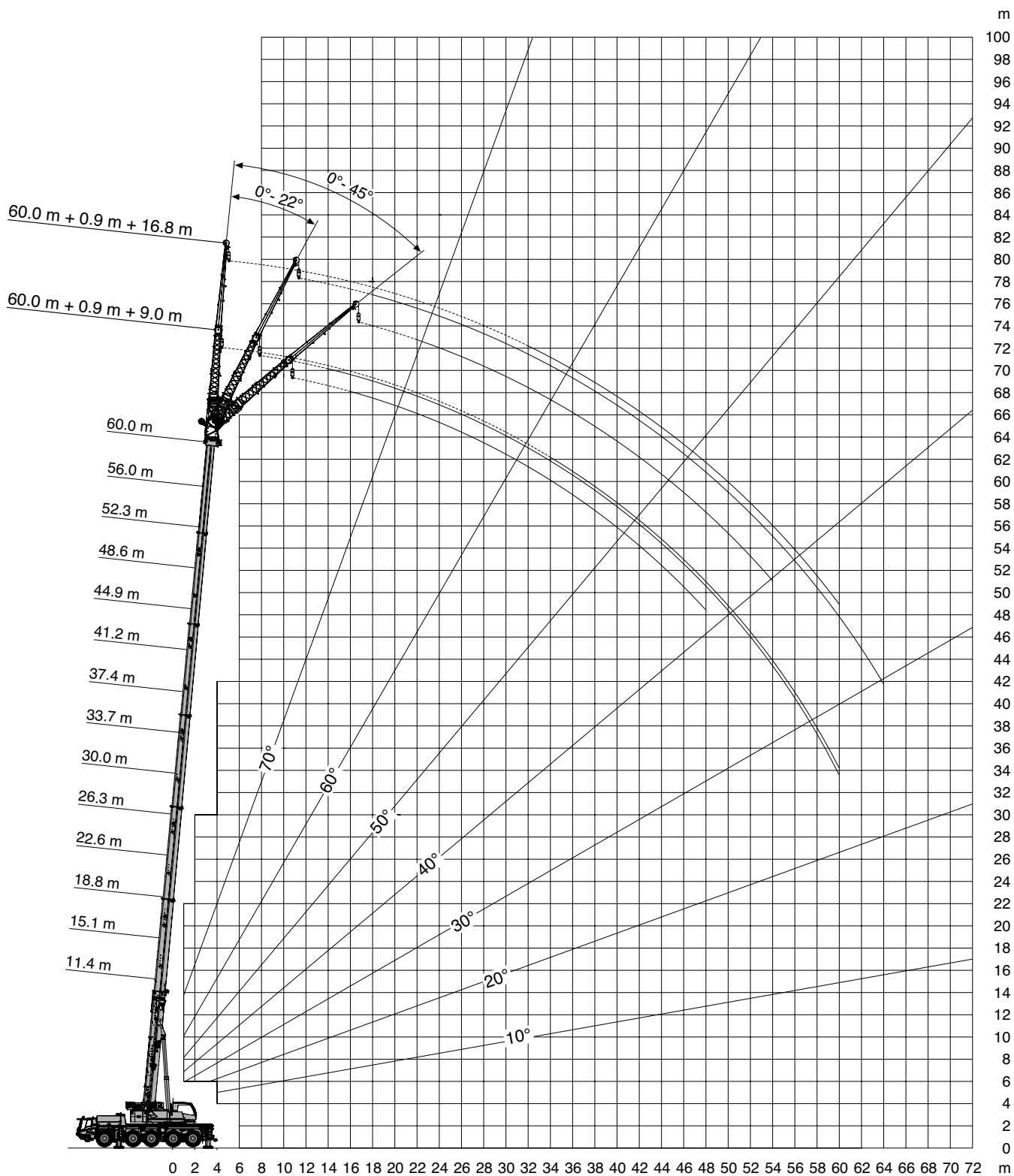
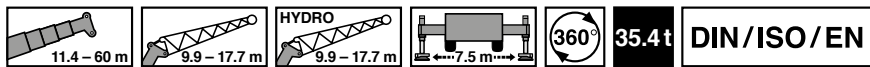

Lifting capacities · Traglasten · Charges de levage
 Cargas · Portate · Грузоподъемность

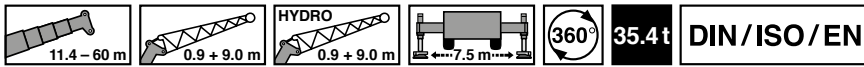

m	11.4 m + 0.9 m + 9.0 m			30.0 m + 0.9 m + 9.0 m			44.9 m + 0.9 m + 9.0 m			56.0 m + 0.9 m + 9.0 m			60.0 m + 0.9 m + 9.0 m		
	0°	22°	45°	0°	22°	45°	0°	22°	45°	0°	22°	45°	0°	22°	45°
3.5		10.7													
4.0		10.7													
4.5		10.7													
5.0		10.7													
6.0		10.7				10.7									
7.0		10.7	9.5			10.7									
8.0	10.7	10.7	9.1			10.7									
9.0	10.7	10.7	8.7			10.7	9.3		5.0						
10.0	10.7	10.7	8.3			10.7	9.1		5.0						
11.0	10.7	10.3	8.0			10.7	8.9		5.0						
12.0	10.7	9.7	7.7			10.7	8.7		5.0	5.0		4.0			
14.0	9.1	8.8	7.3			10.7	8.3		5.0	5.0		4.0			
16.0	7.9	8.1	7.1			10.5	7.9		5.0	5.0		4.0	4.0		3.6
18.0	6.9	7.6		10.7	9.9	7.6			5.0	5.0		4.0	4.0		3.6
20.0				10.7	9.4	7.4			5.0	5.0		4.0	4.0		3.6
22.0				10.7	9.2	7.2			5.0	5.0		4.0	4.0		3.6
24.0				10.0	8.7	7.0		5.0	5.0	5.0		4.0	4.0		3.6
26.0				9.2	8.3	6.8		5.0	5.0	5.0		4.0	4.0		3.6
28.0				8.4	7.9	6.7		5.0	5.0	5.0		4.0	4.0		3.6
30.0				7.4	7.6			5.0	5.0	5.0	4.0	4.0	4.0		3.6
32.0				6.6	6.8			5.0	5.0	5.0	4.0	4.0	4.0		3.6
34.0				5.8	6.0			5.0	5.0	5.0	4.0	4.0	4.0	3.6	3.6
36.0				5.3				4.9	4.8	5.0	4.0	4.0	3.9	3.6	3.6
38.0								4.6	4.3	4.4	4.0	3.9	3.7	3.6	3.5
40.0								4.2	4.1		3.7	3.8	3.6	3.5	3.4
42.0								3.7	3.9		3.2	3.5	3.5	3.1	3.3
44.0								3.3	3.5		2.8	3.1	3.2	2.7	3.0
46.0								3.1	3.1		2.4	2.7	2.8	2.3	2.6
48.0								3.0	2.9		2.1	2.3		2.0	2.2
50.0								2.8			1.8	2.0		1.7	1.9
52.0								2.5			1.5	1.7		1.4	1.6
54.0											1.2	1.4		1.1	1.3
56.0											1.0	1.1		0.9	1.1
58.0											0.8	0.9		0.7	0.8
60.0											0.6			0.5	0.6

Operation · Einsatz · Utilisation
 Uso · Эксплуатация

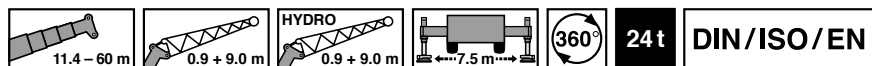

m	11.4 m + 0.9 m + 9.0 m			30.0 m + 0.9 m + 9.0 m			44.9 m + 0.9 m + 9.0 m			56.0 m + 0.9 m + 9.0 m			60.0 m + 0.9 m + 9.0 m		
	0°	22°	45°	0°	22°	45°	0°	22°	45°	0°	22°	45°	0°	22°	45°
3.5		10.7													
4.0		10.7													
4.5		10.7													
5.0		10.7													
6.0		10.7													
7.0		10.7	9.5		10.7										
8.0	10.7	10.7	9.1		10.7										
9.0	10.7	10.7	8.7		10.7		5.0								
10.0	10.7	10.7	8.3		10.7	9.3	5.0								
11.0	10.7	10.3	8.0		10.7	9.1	5.0								
12.0	10.7	9.7	7.7		10.7	8.9	5.0	5.0			4.0				
14.0	9.1	8.8	7.3		10.7	8.7	5.0	5.0		4.0			3.6		
16.0	7.9	8.1	7.1		10.7	8.3	5.0	5.0		4.0	4.0		3.6	3.6	
18.0	6.9	7.6			10.5	7.9	5.0	5.0		4.0	4.0		3.6	3.6	
20.0				10.7	9.9	7.6	5.0	5.0		4.0	4.0		3.6	3.6	
22.0				10.7	9.4	7.4	5.0	5.0		4.0	4.0		3.6	3.6	
24.0				9.5	9.1	7.2	5.0	5.0		4.0	4.0		3.6	3.6	
26.0				8.1	8.6	7.0	5.0	5.0		4.0	4.0		3.6	3.6	
28.0				7.0	7.4	6.8	5.0	5.0		4.0	4.0		3.6	3.6	
30.0				6.5	6.4	6.6	5.0	5.0		4.0	4.0		3.6	3.6	
32.0				5.9	5.5		4.6	4.9	4.6	4.0	4.0		3.6	3.6	
34.0				5.1	5.2		4.3	4.3	4.4	3.4	3.9	4.0	3.3	3.6	3.6
36.0				4.5	4.7		3.9	3.7	3.9	2.9	3.3	3.6	2.8	3.2	3.5
38.0				4.0			3.4	3.6	3.4	2.4	2.8	3.0	2.3	2.7	3.0
40.0							3.0	3.2		2.0	2.3	2.5	1.9	2.3	2.5
42.0							2.6	2.8		1.6	1.9	2.1	1.5	1.8	2.1
44.0							2.3	2.4		1.3	1.5	1.7	1.2	1.5	1.7
46.0							2.0	2.1		1.0	1.2	1.4	0.9	1.2	1.3
48.0							1.7	1.8		0.7	0.9		0.6	0.9	1.0
50.0							1.5				0.6			0.6	
52.0							1.3								

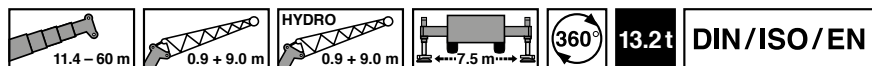

m	11.4 m + 0.9 m + 9.0 m			30.0 m + 0.9 m + 9.0 m			44.9 m + 0.9 m + 9.0 m			56.0 m + 0.9 m + 9.0 m			60.0 m + 0.9 m + 9.0 m		
	0°	22°	45°	0°	22°	45°	0°	22°	45°	0°	22°	45°	0°	22°	45°
3.5		10.7													
4.0		10.7													
4.5		10.7													
5.0		10.7													
6.0		10.7													
7.0		10.7	9.5		10.7										
8.0	10.7	10.7	9.1		10.7										
9.0	10.7	10.7	8.7		10.7	9.3		5.0							
10.0	10.7	10.7	8.3		10.7	9.1		5.0							
11.0	10.7	10.3	8.0		10.7	8.9		5.0							
12.0	10.7	9.7	7.7		10.7	8.7		5.0	5.0		4.0				
14.0	9.1	8.8	7.3		10.7	8.3		5.0	5.0		4.0			3.6	
16.0	7.9	8.1	7.1		10.5	7.9		5.0	5.0		4.0	4.0		3.6	3.6
18.0	6.9	7.6		9.6	9.9	7.6		5.0	5.0		4.0	4.0		3.6	3.6
20.0				8.5	8.4	7.4		5.0	5.0		4.0	4.0		3.6	3.6
22.0				7.1	7.0	7.1		5.0	5.0		4.0	4.0		3.6	3.6
24.0				6.0	6.3	6.2	5.0	5.0	5.0		4.0	4.0		3.6	3.6
26.0				5.2	5.4	5.5	4.9	5.0	5.0		4.0	4.0		3.6	3.6
28.0				4.7	4.6	4.8	4.2	4.6	4.5		3.4	3.8		3.2	3.6
30.0				4.0	4.3		3.5	3.9	4.2	2.3	2.8	3.2		2.6	3.0
32.0				3.5	3.7		3.0	3.3	3.6	1.8	2.3	2.6		2.1	2.5
34.0				3.2	3.1		2.5	2.8	3.0	1.4	1.8	2.1		1.7	2.0
36.0				2.9			2.1	2.3	2.5	1.0	1.4	1.7		1.3	1.6
38.0							1.7	1.9	2.1	0.7	1.0	1.3		0.9	1.2
40.0							1.4	1.6			0.7	0.9		0.6	0.8
42.0							1.1	1.3				0.6			0.5
44.0							0.8	1.0							
46.0							0.6	0.7							
48.0								0.5							

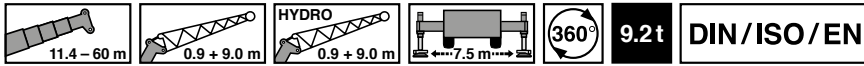

m	11.4 m + 0.9 m + 9.0 m			30.0 m + 0.9 m + 9.0 m			44.9 m + 0.9 m + 9.0 m			56.0 m + 0.9 m + 9.0 m			60.0 m + 0.9 m + 9.0 m		
	0°	22°	45°	0°	22°	45°	0°	22°	45°	0°	22°	45°	0°	22°	45°
3.5		10.7													
4.0		10.7													
4.5		10.7													
5.0		10.7													
6.0		10.7			10.7										
7.0		10.7	9.5		10.7										
8.0	10.7	10.7	9.1		10.7										
9.0	10.7	10.7	8.7		10.7	9.3		5.0							
10.0	10.7	10.7	8.3		10.7	9.1		5.0							
11.0	10.7	10.3	8.0		10.7	8.9		5.0							
12.0	10.7	9.7	7.7		10.7	8.7		5.0	5.0		4.0				
14.0	9.1	8.8	7.3		10.7	8.3		5.0	5.0		4.0			3.6	
16.0	7.9	8.1	7.1		10.2	7.9		5.0	5.0		4.0	4.0		3.6	3.6
18.0	6.9	7.6		8.5	8.5	7.6		5.0	5.0		4.0	4.0		3.6	3.6
20.0				7.1	7.2	7.3		5.0	5.0		4.0	4.0		3.6	3.6
22.0				6.2	6.5	6.3		5.0	5.0		4.0	4.0		3.6	3.6
24.0				5.3	5.4	5.7	4.6	5.0	5.0		3.8	4.0		3.6	3.6
26.0				4.5	4.9	4.7	3.9	4.4	4.7		3.1	3.6		2.9	3.4
28.0				4.0	4.1	4.3	3.3	3.7	4.1		2.5	2.9		2.3	2.8
30.0				3.6	3.6		2.7	3.1	3.4		1.9	2.3		1.8	2.2
32.0				3.0	3.2		2.2	2.6	2.8		1.4	1.8		1.3	1.7
34.0				2.6	2.8		1.8	2.1	2.3		1.0	1.3		0.9	1.2
36.0				2.3			1.4	1.7	1.8		0.7	0.9		0.5	0.8
38.0							1.0	1.3	1.4			0.6			0.5
40.0							0.7	1.0							
42.0							0.5	0.7							

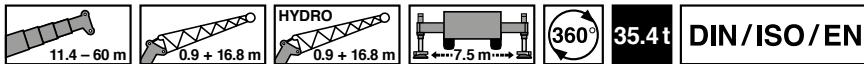

m	11.4 m + 0.9 m + 16.8 m			30.0 m + 0.9 m + 16.8 m			44.9 m + 0.9 m + 16.8 m			56.0 m + 0.9 m + 16.8 m			60.0 m + 0.9 m + 16.8 m		
	0°	22°	45°	0°	22°	45°	0°	22°	45°	0°	22°	45°	0°	22°	45°
7.0		4.1													
8.0		3.8													
9.0		3.6													
10.0	4.3	3.4			3.5										
11.0	4.0	3.2			3.5										
12.0	3.8	3.1			3.3										
14.0	3.4	2.8	2.5		3.1			2.8							
16.0	3.1	2.6	2.3		3.0	2.4		2.8			2.5				
18.0	2.8	2.5	2.2	3.8	2.8	2.3		2.8	2.2		2.5			2.3	
20.0	2.6	2.3	2.1	3.5	2.7	2.2		2.6	2.2		2.5			2.3	
22.0	2.4	2.2	2.1	3.4	2.5	2.2		2.5	2.1		2.4	2.0		2.3	2.0
24.0	2.3	2.1		3.2	2.4	2.1	2.8	2.5	2.1		2.3	2.0		2.3	1.9
26.0	2.2	2.1		3.0	2.3	2.1	2.8	2.4	2.0		2.3	1.9		2.2	1.9
28.0				2.8	2.3	2.0	2.8	2.3	2.0		2.2	1.9		2.2	1.9
30.0				2.7	2.2	2.0	2.8	2.2	1.9	2.5	2.1	1.9		2.1	1.8
32.0				2.6	2.1	2.0	2.8	2.2	1.9	2.5	2.1	1.8	2.3	2.1	1.8
34.0				2.4	2.1	1.9	2.7	2.1	1.9	2.5	2.0	1.8	2.3	2.0	1.8
36.0				2.4	2.0	1.9	2.6	2.0	1.8	2.5	2.0	1.8	2.3	2.0	1.7
38.0				2.3	2.0		2.5	2.0	1.8	2.5	1.9	1.7	2.3	1.9	1.7
40.0				2.2	2.0		2.4	1.9	1.8	2.4	1.9	1.7	2.3	1.9	1.7
42.0				2.1	2.0		2.3	1.9	1.8	2.3	1.8	1.7	2.3	1.8	1.7
44.0				2.1			2.3	1.9	1.8	2.2	1.8	1.7	2.2	1.8	1.6
46.0							2.2	1.8	1.8	2.2	1.8	1.7	2.2	1.8	1.6
48.0							2.1	1.8		2.1	1.7	1.6	2.1	1.7	1.6
50.0							2.1	1.8		2.0	1.7	1.6	1.9	1.7	1.6
52.0							2.0	1.8		1.7	1.7	1.6	1.6	1.7	1.6
54.0							2.0	1.8		1.4	1.7		1.3	1.6	1.6
56.0							1.9	1.8		1.2	1.5		1.1	1.4	
58.0							1.8			1.0	1.2		0.9	1.2	
60.0										0.8	1.0		0.6	0.9	
64.0											0.6			0.5	

Operation · Einsatz · Utilisation
 Uso · Эксплуатация

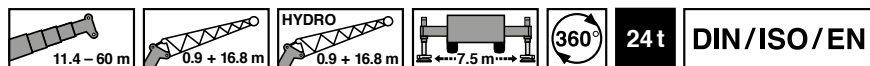

m	11.4 m + 0.9 m + 16.8 m			30.0 m + 0.9 m + 16.8 m			44.9 m + 0.9 m + 16.8 m			56.0 m + 0.9 m + 16.8 m			60.0 m + 0.9 m + 16.8 m		
	0°	22°	45°	0°	22°	45°	0°	22°	45°	0°	22°	45°	0°	22°	45°
7.0		4.1													
8.0		3.8													
9.0		3.6													
10.0	4.3	3.4				3.5									
11.0	4.0	3.2				3.5									
12.0	3.8	3.1				3.3									
14.0	3.4	2.8	2.5			3.1			2.8						
16.0	3.1	2.6	2.3			3.0	2.4		2.8			2.5			
18.0	2.8	2.5	2.2	3.8	2.8	2.3		2.8	2.2			2.5			2.3
20.0	2.6	2.3	2.1	3.5	2.7	2.2		2.6	2.2			2.5			2.3
22.0	2.4	2.2	2.1	3.4	2.5	2.2		2.5	2.1			2.4	2.0		2.3
24.0	2.3	2.1		3.2	2.4	2.1	2.8	2.5	2.1			2.3	2.0		2.3
26.0	2.2	2.1		3.0	2.3	2.1	2.8	2.4	2.0			2.3	1.9		2.2
28.0				2.8	2.3	2.0	2.8	2.3	2.0			2.2	1.9		2.2
30.0				2.7	2.2	2.0	2.8	2.2	1.9	2.5	2.1	1.9			2.1
32.0				2.6	2.1	2.0	2.8	2.2	1.9	2.5	2.1	1.8	2.3	2.1	1.8
34.0				2.4	2.1	1.9	2.7	2.1	1.9	2.5	2.0	1.8	2.3	2.0	1.8
36.0				2.4	2.0	1.9	2.6	2.0	1.8	2.5	2.0	1.8	2.3	2.0	1.7
38.0				2.3	2.0		2.5	2.0	1.8	2.5	1.9	1.7	2.3	1.9	1.7
40.0				2.2	2.0		2.3	1.9	1.8	2.2	1.9	1.7	2.1	1.9	1.7
42.0				2.1	1.9		2.3	1.9	1.8	1.9	1.8	1.7	1.7	1.8	1.7
44.0				2.1			2.2	1.8	1.8	1.5	1.8	1.7	1.4	1.8	1.6
46.0							2.1	1.8	1.7	1.2	1.7	1.7	1.1	1.6	1.6
48.0							1.9	1.8		0.9	1.4	1.6	0.8	1.3	1.6
50.0							1.6	1.8		0.7	1.1	1.3	0.6	1.0	1.3
52.0							1.4	1.6			0.8	1.0		0.7	1.0
54.0							1.2	1.4			0.6			0.5	0.7
56.0							1.0	1.2							
58.0							0.8								

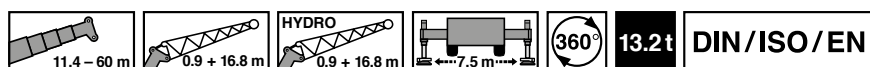

m	11.4 m + 0.9 m + 16.8 m			30.0 m + 0.9 m + 16.8 m			44.9 m + 0.9 m + 16.8 m			56.0 m + 0.9 m + 16.8 m			60.0 m + 0.9 m + 16.8 m		
	0°	22°	45°	0°	22°	45°	0°	22°	45°	0°	22°	45°	0°	22°	45°
7.0		4.1													
8.0		3.8													
9.0		3.6													
10.0	4.3	3.4				3.5									
11.0	4.0	3.2				3.5									
12.0	3.8	3.1				3.3									
14.0	3.4	2.8	2.5			3.1			2.8						
16.0	3.1	2.6	2.3			3.0	2.4		2.8			2.5			
18.0	2.8	2.5	2.2	3.8	2.8	2.3		2.8	2.2			2.5			2.3
20.0	2.6	2.3	2.1	3.5	2.7	2.2		2.6	2.2			2.5			2.3
22.0	2.4	2.2	2.1	3.4	2.5	2.2		2.5	2.1			2.4	2.0		2.3
24.0	2.3	2.1		3.2	2.4	2.1	2.8	2.5	2.1			2.3	2.0		2.3
26.0	2.2	2.1		3.0	2.3	2.1	2.8	2.4	2.0			2.3	1.9		2.2
28.0				2.8	2.3	2.0	2.8	2.3	2.0			2.2	1.9		2.2
30.0				2.7	2.2	2.0	2.8	2.2	1.9	2.5	2.1	1.9			2.1
32.0				2.5	2.1	2.0	2.7	2.2	1.9	2.0	2.1	1.8	2.3	2.1	1.8
34.0				2.4	2.1	1.9	2.6	2.1	1.9	1.6	2.0	1.8	2.0	2.0	1.8
36.0				2.3	2.0	1.9	2.3	2.0	1.8	1.2	1.9	1.8	1.8	1.8	1.7
38.0				2.2	2.0		1.9	2.0	1.8	0.9	1.5	1.7	1.4	1.7	1.7
40.0				2.1	1.9		1.6	1.9	1.8	0.6	1.2	1.6	1.0	1.5	1.5
42.0				2.0	1.9		1.3	1.7	1.7		0.8	1.3	0.7	1.2	1.2
44.0				1.9			1.0	1.4	1.6		0.5	0.9			0.8
46.0							0.8	1.1	1.3			0.6			0.5
48.0							0.6	0.8							
50.0								0.6							

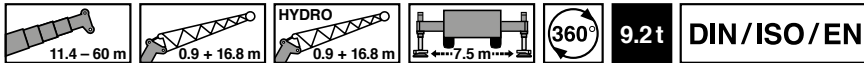

 m	11.4 m + 0.9 m + 16.8 m			30.0 m + 0.9 m + 16.8 m			44.9 m + 0.9 m + 16.8 m			56.0 m + 0.9 m + 16.8 m			60.0 m + 0.9 m + 16.8 m		
	0°	22°	45°	0°	22°	45°	0°	22°	45°	0°	22°	45°	0°	22°	45°
7.0		4.1													
8.0		3.8													
9.0		3.6													
10.0	4.3	3.4			3.5										
11.0	4.0	3.2			3.5										
12.0	3.8	3.1			3.3										
14.0	3.4	2.8	2.5		3.1			2.8							
16.0	3.1	2.6	2.3		3.0	2.4		2.8			2.5				
18.0	2.8	2.5	2.2	3.8	2.8	2.3		2.8	2.2		2.5			2.3	
20.0	2.6	2.3	2.1	3.5	2.7	2.2		2.6	2.2		2.5			2.3	
22.0	2.4	2.2	2.1	3.4	2.5	2.2		2.5	2.1		2.4	2.0		2.3	2.0
24.0	2.3	2.1		3.2	2.4	2.1	2.8	2.5	2.1		2.3	2.0		2.3	1.9
26.0	2.2	2.1		2.9	2.3	2.1	2.8	2.4	2.0		2.3	1.9		2.2	1.9
28.0				2.8	2.3	2.0	2.8	2.3	2.0		2.2	1.9		2.2	1.9
30.0				2.6	2.2	2.0	2.8	2.2	1.9		2.1	1.9		2.1	1.8
32.0				2.5	2.1	2.0	2.5	2.1	1.9		2.0	1.8		1.9	1.8
34.0				2.4	2.1	1.9	2.0	2.1	1.9		1.6	1.8		1.4	1.8
36.0				2.3	2.0	1.9	1.6	2.0	1.8		1.2	1.7		1.0	1.6
38.0				2.2	1.9		1.3	1.8	1.8		0.8	1.3		0.7	1.2
40.0				1.9	1.9		1.0	1.4	1.8		0.5	1.0			0.9
42.0				1.6	1.8		0.7	1.1	1.4			0.6			0.5
44.0				1.4			0.5	0.8	1.1						
46.0								0.6	0.8						

Operation · Einsatz · Utilisation
 Uso · Эксплуатация

Working range · Arbeitsbereich · Rayon de travail
 Zona de trabajo · Area di lavoro · Рабочая зона

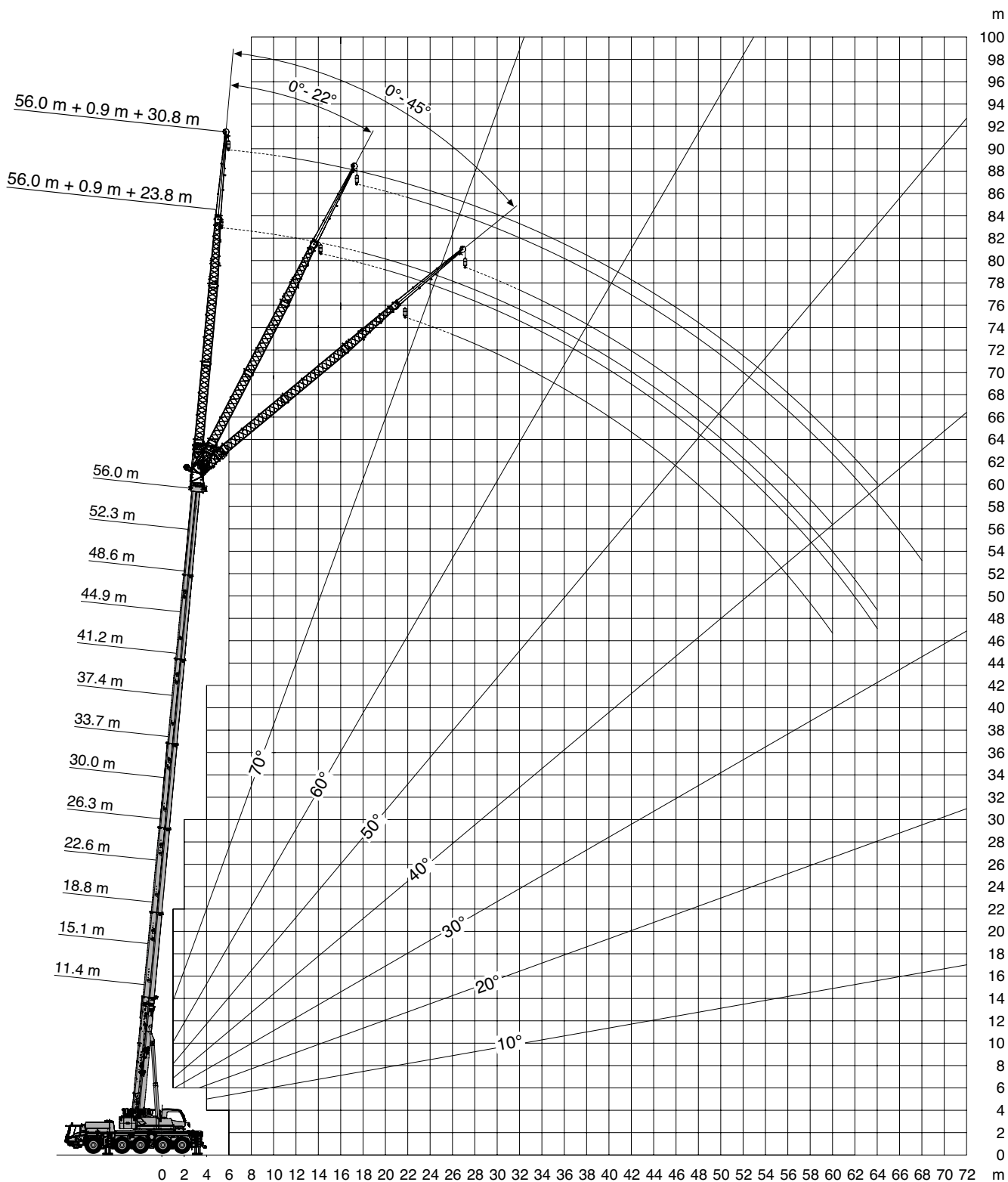
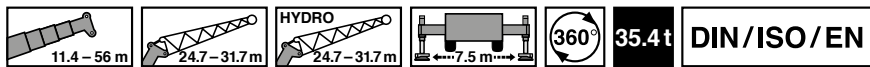

Lifting capacities · Traglasten · Charges de levage
 Cargas · Portate · Грузоподъемность

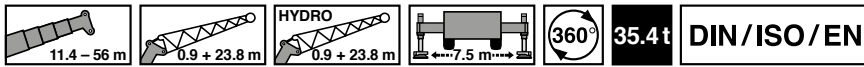

m	11.4 m + 0.9 m + 23.8 m			22.6 m + 0.9 m + 23.8 m			33.7 m + 0.9 m + 23.8 m			44.9 m + 0.9 m + 23.8 m			56.0 m + 0.9 m + 23.8 m		
	0°	22°	45°	0°	22°	45°	0°	22°	45°	0°	22°	45°	0°	22°	45°
6.0	3.7														
7.0	3.7														
8.0	3.7			2.8											
9.0	3.7			2.8											
10.0	3.7			2.8											
11.0	3.7	3.6		2.8			2.8								
12.0	3.7	3.4		2.8	2.8		2.8								
14.0	3.7	3.1		2.8	2.8		2.8	2.8		1.9					
16.0	3.4	2.9		2.8	2.8		2.8	2.8		1.9	1.9				
18.0	3.1	2.7	2.4	2.8	2.8		2.8	2.8		1.9	1.9		1.8		
20.0	2.9	2.5	2.3	2.8	2.6	2.3	2.8	2.7		1.9	1.9		1.8	1.8	
22.0	2.7	2.4	2.2	2.8	2.5	2.2	2.8	2.6	2.2	1.9	1.9		1.8	1.8	
24.0	2.6	2.3	2.1	2.8	2.4	2.2	2.8	2.5	2.1	1.9	1.9	1.9	1.8	1.8	
26.0	2.3	2.2	2.0	2.8	2.3	2.1	2.8	2.4	2.1	1.9	1.9	1.9	1.8	1.8	1.8
28.0	2.1	2.1	2.0	2.6	2.2	2.0	2.8	2.3	2.0	1.9	1.9	1.9	1.8	1.8	1.8
30.0	1.9	2.0	2.0	2.5	2.2	2.0	2.7	2.2	2.0	1.9	1.9	1.9	1.8	1.8	1.8
32.0	1.8	2.0		2.4	2.1	1.9	2.6	2.1	1.9	1.9	1.9	1.9	1.8	1.8	1.8
34.0				2.3	2.0	1.9	2.5	2.1	1.9	1.9	1.9	1.9	1.8	1.8	1.8
36.0				2.1	2.0	1.9	2.4	2.0	1.9	1.9	1.9	1.9	1.8	1.8	1.7
38.0				2.0	1.9	1.9	2.4	2.0	1.8	1.9	1.9	1.8	1.8	1.8	1.7
40.0				1.9	1.9		2.3	1.9	1.8	1.9	1.9	1.8	1.8	1.8	1.7
42.0				1.8	1.9		2.2	1.9	1.8	1.9	1.9	1.7	1.8	1.8	1.7
44.0				1.7			2.1	1.9	1.8	1.9	1.8	1.7	1.8	1.7	1.6
46.0							2.0	1.8	1.8	1.9	1.8	1.7	1.8	1.7	1.6
48.0							1.9	1.8		1.9	1.8	1.7	1.8	1.7	1.6
50.0							1.8	1.8		1.9	1.7	1.7	1.8	1.7	1.6
52.0							1.7	1.8		1.9	1.7	1.7	1.8	1.6	1.6
54.0							1.7	1.8		1.9	1.7		1.6	1.6	1.5
56.0										1.9	1.7		1.3	1.6	1.5
58.0										1.7	1.6		1.1	1.5	1.5
60.0										1.5	1.6		0.9	1.3	1.4
64.0										1.1	0.6		0.5	0.8	

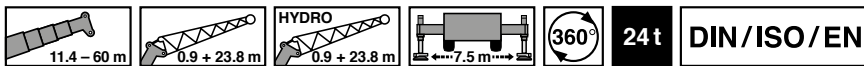

m	11.4 m + 0.9 m + 23.8 m			22.6 m + 0.9 m + 23.8 m			33.7 m + 0.9 m + 23.8 m			44.9 m + 0.9 m + 23.8 m			56.0 m + 0.9 m + 23.8 m		
	0°	22°	45°	0°	22°	45°	0°	22°	45°	0°	22°	45°	0°	22°	45°
6.0	3.7														
7.0	3.7														
8.0	3.7			2.8											
9.0	3.7			2.8											
10.0	3.7			2.8											
11.0	3.7	3.6		2.8			2.8								
12.0	3.7	3.4		2.8	2.8		2.8								
14.0	3.7	3.1		2.8	2.8		2.8	2.8		1.9					
16.0	3.4	2.9		2.8	2.8		2.8	2.8		1.9	1.9				
18.0	3.1	2.7	2.4	2.8	2.8		2.8	2.8		1.9	1.9		1.8		
20.0	2.9	2.5	2.3	2.8	2.6	2.3	2.8	2.7		1.9	1.9		1.8	1.8	
22.0	2.7	2.4	2.2	2.8	2.5	2.2	2.8	2.6	2.2	1.9	1.9		1.8	1.8	
24.0	2.6	2.3	2.1	2.8	2.4	2.2	2.8	2.5	2.1	1.9	1.9	1.9	1.8	1.8	
26.0	2.3	2.2	2.0	2.8	2.3	2.1	2.8	2.4	2.1	1.9	1.9	1.9	1.8	1.8	1.8
28.0	2.1	2.1	2.0	2.6	2.2	2.0	2.8	2.3	2.0	1.9	1.9	1.9	1.8	1.8	1.8
30.0	1.9	2.0	2.0	2.5	2.2	2.0	2.7	2.2	2.0	1.9	1.9	1.9	1.8	1.8	1.8
32.0	1.8	2.0		2.4	2.1	1.9	2.6	2.1	1.9	1.9	1.9	1.9	1.8	1.8	1.8
34.0				2.3	2.0	1.9	2.5	2.1	1.9	1.9	1.9	1.9	1.8	1.8	1.8
36.0				2.1	2.0	1.9	2.4	2.0	1.9	1.9	1.9	1.8	1.8	1.8	1.7
38.0				2.0	1.9	1.9	2.4	2.0	1.8	1.9	1.9	1.8	1.8	1.8	1.7
40.0				1.9	1.9		2.3	1.9	1.8	1.9	1.9	1.8	1.8	1.8	1.7
42.0				1.8	1.9		2.2	1.9	1.8	1.9	1.9	1.7	1.8	1.8	1.7
44.0				1.7			2.1	1.9	1.8	1.9	1.8	1.7	1.7	1.7	1.6
46.0							2.0	1.8	1.8	1.9	1.8	1.7	1.4	1.7	1.6
48.0							1.9	1.8		1.9	1.7	1.7	1.1	1.7	1.6
50.0							1.8	1.8		1.8	1.7	1.7	0.8	1.4	1.6
52.0							1.7	1.7		1.5	1.6	1.6	0.6	1.2	1.6
54.0							1.5	1.4		1.3	1.5			0.9	1.3
56.0										1.1	1.4			0.7	1.0
58.0										0.9	1.2				0.7
60.0										0.7	1.0				0.5

Operation · Einsatz · Utilisation
 Uso · Эксплуатация

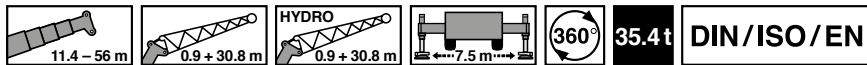

m	11.4 m + 0.9 m + 30.8 m			22.6 m + 0.9 m + 30.8 m			33.7 m + 0.9 m + 30.8 m			44.9 m + 0.9 m + 30.8 m			56.0 m + 0.9 m + 30.8 m		
	0°	22°	45°	0°	22°	45°	0°	22°	45°	0°	22°	45°	0°	22°	45°
3.0	2.7														
3.5	2.7														
4.0	2.7														
4.5	2.7			2.0											
5.0	2.7			2.0											
6.0	2.7			2.0											
7.0	2.7			2.0											
8.0	2.7			2.0			2.0								
9.0	2.7			2.0			2.0								
10.0	2.7			2.0			2.0								
11.0	2.7			2.0			2.0			1.5			1.4		
12.0	2.7			2.0			2.0			1.5			1.4		
14.0	2.7	2.7		2.0			2.0			1.5			1.4		
16.0	2.7	2.7		2.0	2.0		2.0			1.5			1.4		
18.0	2.7	2.7		2.0	2.0		2.0	2.0		1.5			1.4		
20.0	2.7	2.7		2.0	2.0		2.0	2.0		1.5	1.5		1.4		
22.0	2.4	2.4		2.0	2.0		2.0	2.0		1.5	1.5		1.4	1.4	
24.0	2.1	2.2	1.7	2.0	2.0		2.0	2.0		1.5	1.5		1.4	1.4	
26.0	1.9	2.0	1.6	2.0	2.0	1.6	2.0	2.0	1.6	1.5	1.5		1.4	1.4	
28.0	1.7	1.8	1.4	2.0	2.0	1.5	2.0	2.0	1.5	1.5	1.5		1.4	1.4	
30.0	1.5	1.7	1.3	2.0	2.0	1.4	2.0	2.0	1.4	1.5	1.5	1.4	1.4	1.4	
32.0	1.4	1.5	1.2	1.9	1.8	1.3	2.0	2.0	1.4	1.5	1.5	1.4	1.4	1.4	1.3
34.0	1.2	1.4	1.2	1.8	1.7	1.3	2.0	1.9	1.3	1.5	1.5	1.3	1.4	1.4	1.3
36.0	1.1	1.3	1.1	1.6	1.6	1.2	2.0	1.8	1.2	1.5	1.5	1.3	1.4	1.4	1.2
38.0	1.0	1.2	1.1	1.5	1.5	1.1	1.9	1.7	1.2	1.5	1.5	1.2	1.4	1.4	1.2
40.0	0.9	1.2		1.4	1.4	1.1	1.8	1.6	1.1	1.5	1.5	1.2	1.4	1.4	1.1
42.0				1.2	1.3	1.1	1.6	1.5	1.1	1.5	1.5	1.1	1.4	1.4	1.1
44.0				1.1	1.3	1.0	1.5	1.4	1.1	1.5	1.5	1.1	1.4	1.4	1.1
46.0				1.1	1.2	1.0	1.4	1.4	1.0	1.5	1.5	1.0	1.4	1.4	1.0
48.0				1.0	1.2		1.3	1.3	1.0	1.5	1.4	1.0	1.4	1.4	1.0
50.0				0.9	1.1		1.2	1.3	1.0	1.5	1.3	1.0	1.4	1.4	1.0
52.0							1.2	1.2	1.0	1.4	1.3	0.9	1.4	1.3	0.9
54.0							1.1	1.2	0.9	1.3	1.2	0.9	1.4	1.2	0.9
56.0							1.0	1.1		1.3	1.2	0.9	1.3	1.1	0.9
58.0							1.0	1.1		1.2	1.2	0.9	1.1	1.1	0.9
60.0							0.9	1.1		1.1	1.1	0.9	0.9	1.0	0.8
64.0										1.0	1.0		0.5	0.8	
68.0										0.7	0.8			0.6	
72.0										0.5					

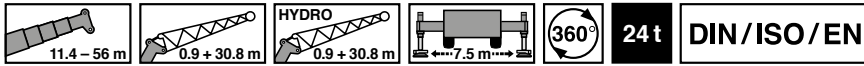

m	11.4 m + 0.9 m + 30.8 m			22.6 m + 0.9 m + 30.8 m			33.7 m + 0.9 m + 30.8 m			44.9 m + 0.9 m + 30.8 m			56.0 m + 0.9 m + 30.8 m		
	0°	22°	45°	0°	22°	45°	0°	22°	45°	0°	22°	45°	0°	22°	45°
3.0	2.7														
3.5	2.7														
4.0	2.7														
4.5	2.7			2.0											
5.0	2.7			2.0											
6.0	2.7			2.0											
7.0	2.7			2.0											
8.0	2.7			2.0			2.0								
9.0	2.7			2.0			2.0								
10.0	2.7			2.0			2.0								
11.0	2.7			2.0			2.0			1.5			1.4		
12.0	2.7			2.0			2.0			1.5			1.4		
14.0	2.7	2.7		2.0			2.0			1.5			1.4		
16.0	2.7	2.7		2.0	2.0		2.0			1.5			1.4		
18.0	2.7	2.7		2.0	2.0		2.0	2.0		1.5			1.4		
20.0	2.7	2.7		2.0	2.0		2.0	2.0		1.5	1.5		1.4		
22.0	2.4	2.4		2.0	2.0		2.0	2.0		1.5	1.5		1.4	1.4	
24.0	2.1	2.2	1.7	2.0	2.0		2.0	2.0		1.5	1.5		1.4	1.4	
26.0	1.9	2.0	1.6	2.0	2.0	1.6	2.0	2.0	1.6	1.5	1.5		1.4	1.4	
28.0	1.7	1.8	1.4	2.0	2.0	1.5	2.0	2.0	1.5	1.5	1.5		1.4	1.4	
30.0	1.5	1.7	1.3	2.0	2.0	1.4	2.0	2.0	1.4	1.5	1.5	1.4	1.4	1.4	
32.0	1.4	1.5	1.2	1.9	1.8	1.3	2.0	2.0	1.4	1.5	1.5	1.4	1.4	1.4	1.3
34.0	1.2	1.4	1.2	1.8	1.7	1.3	2.0	1.9	1.3	1.5	1.5	1.3	1.4	1.4	1.3
36.0	1.1	1.3	1.1	1.6	1.6	1.2	2.0	1.8	1.2	1.5	1.5	1.3	1.4	1.4	1.2
38.0	1.0	1.2	1.1	1.5	1.5	1.1	1.9	1.7	1.2	1.5	1.5	1.2	1.4	1.4	1.2
40.0	0.9	1.2		1.4	1.4	1.1	1.8	1.6	1.1	1.5	1.5	1.2	1.4	1.4	1.1
42.0				1.2	1.3	1.1	1.6	1.5	1.1	1.5	1.5	1.1	1.4	1.4	1.1
44.0				1.1	1.3	1.0	1.5	1.4	1.1	1.5	1.5	1.1	1.4	1.4	1.1
46.0				1.1	1.2	1.0	1.4	1.4	1.0	1.5	1.5	1.0	1.3	1.4	1.0
48.0				1.0	1.2		1.3	1.3	1.0	1.5	1.4	1.0	1.1	1.4	1.0
50.0				0.9	1.1		1.2	1.3	1.0	1.4	1.3	1.0	0.8	1.4	1.0
52.0							1.1	1.2	1.0	1.2	1.3	0.9	0.6	1.3	0.9
54.0							1.1	1.2	0.9	1.1	1.2	0.9		1.0	0.9
56.0							1.0	1.1		1.0	1.2	0.9		0.8	0.9
58.0							0.9	1.1		0.9	1.0	0.9		0.6	0.9
60.0							0.9	1.0		0.7	0.8	0.9			0.8
64.0											0.6				

Operation · Einsatz · Utilisation
 Uso · Эксплуатация

Working range · Arbeitsbereich · Rayon de travail
 Zona de trabajo · Area di lavoro · Рабочая зона

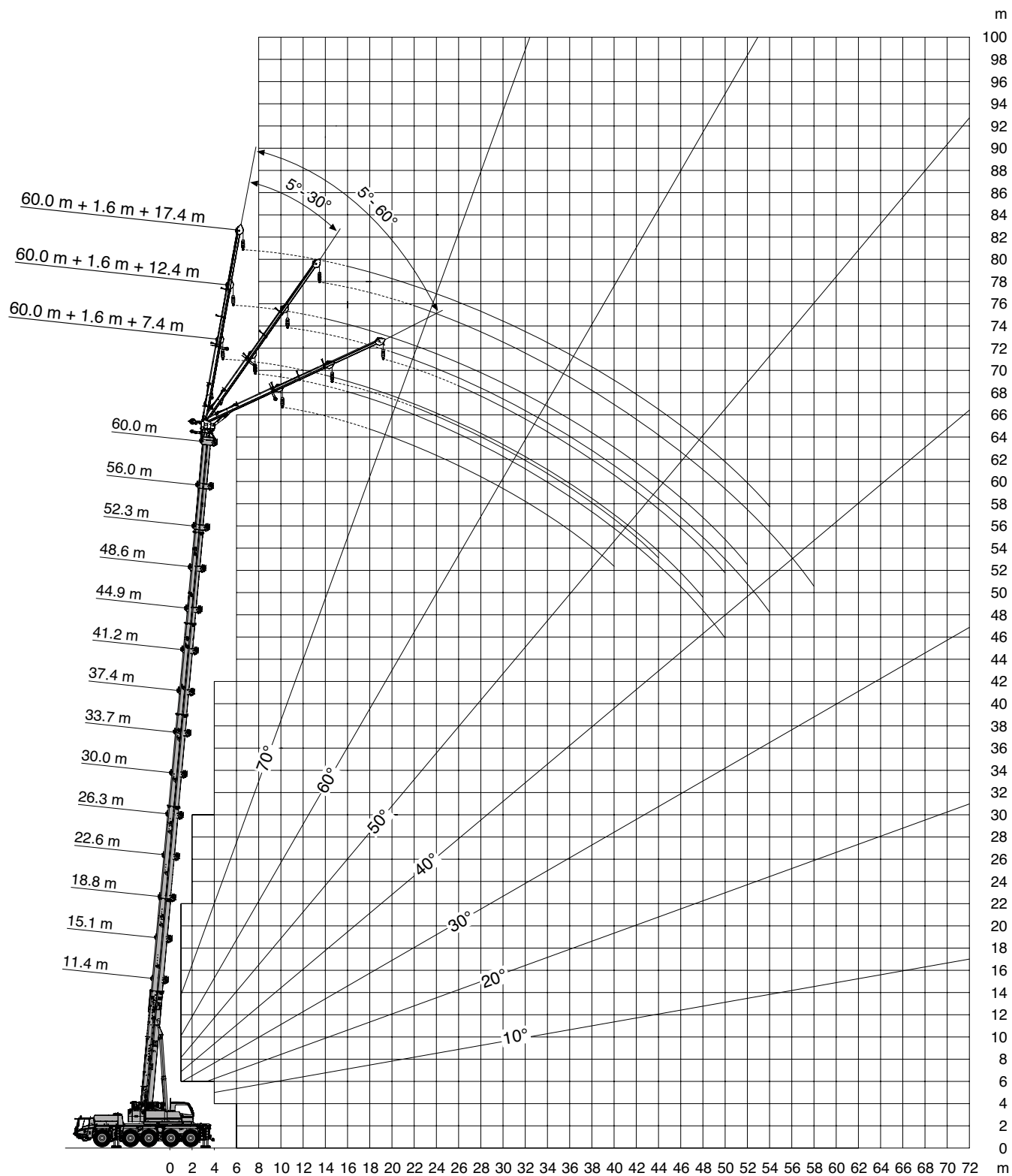
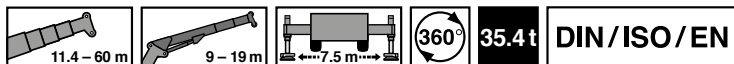

Lifting capacities · Traglasten · Charges de levage
 Cargas · Portate · Грузоподъемность

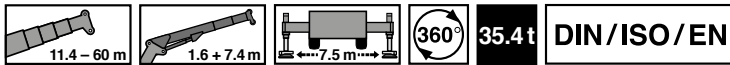

m	11.4 m + 1.6 m + 7.4 m			30.0 m + 1.6 m + 7.4 m			44.9 m + 1.6 m + 7.4 m			56.0 m + 1.6 m + 7.4 m			60.0 m + 1.6 m + 7.4 m		
	5°	30°	60°	5°	30°	60°	5°	30°	60°	5°	30°	60°	5°	30°	60°
3.0	7.3														
3.5	7.3														
4.0	7.3														
4.5	7.3														
5.0	7.3	7.3		7.3											
6.0	7.3	7.3		7.3											
7.0	7.3	7.3	6.5	7.3											
8.0	7.3	7.3	6.3	7.3	7.3		6.5								
9.0	7.3	7.2	6.0	7.3	7.3		6.5								
10.0	7.3	6.9	5.9	7.3	7.3	5.0	6.5								
11.0	7.3	6.6	5.7	7.3	7.3	4.9	6.5	6.5		3.7					
12.0	7.3	6.3	5.6	7.3	7.3	4.9	6.5	6.5		3.7					
14.0	6.4	5.9	5.4	7.3	7.3	4.8	6.5	6.5	4.9	3.7	3.7		3.2		
16.0	5.7	5.6		7.3	7.2	4.7	6.5	6.2	4.8	3.7	3.7	3.7	3.2	3.2	
18.0	5.1			7.3	6.9	4.7	6.5	5.9	4.8	3.7	3.7	3.7	3.2	3.2	3.2
20.0				7.3	6.6	4.7	6.3	5.6	4.7	3.7	3.7	3.7	3.2	3.2	3.2
22.0				7.3	6.3	4.7	5.8	5.4	4.7	3.7	3.7	3.7	3.2	3.2	3.2
24.0				7.3	6.1		5.3	5.2	4.6	3.7	3.7	3.7	3.2	3.1	3.0
26.0				6.9	5.9		4.9	5.0	4.6	3.7	3.7	3.7	3.0	2.9	2.9
28.0				6.4	5.7		4.5	4.6	4.6	3.7	3.6	3.5	2.8	2.8	2.7
30.0				6.0	5.6		4.2	4.2	4.2	3.4	3.4	3.3	2.7	2.6	2.6
32.0				5.3	5.5		4.0	3.9		3.2	3.2	3.1	2.5	2.5	2.4
34.0				4.8			3.7	3.6		2.9	3.0	3.0	2.4	2.3	2.3
36.0				4.5			3.5	3.4		2.7	2.8	2.8	2.3	2.2	2.2
38.0							3.2	3.3		2.5	2.6	2.6	2.1	2.1	2.1
40.0							3.0	3.0		2.3	2.4		2.0	2.0	2.0
42.0							2.8	2.8		2.1	2.2		1.9	1.9	
44.0							2.5	2.5		2.0	2.0		1.7	1.8	
46.0							2.3	2.3		1.6	1.7		1.5	1.6	
48.0							2.2			1.2	1.4		1.1	1.3	
50.0							1.9			0.9	1.0		1.0		

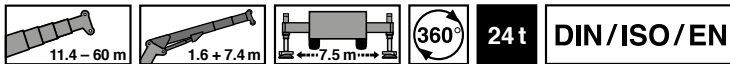

m	11.4 m + 1.6 m + 7.4 m			30.0 m + 1.6 m + 7.4 m			44.9 m + 1.6 m + 7.4 m			56.0 m + 1.6 m + 7.4 m			60.0 m + 1.6 m + 7.4 m		
	5°	30°	60°	5°	30°	60°	5°	30°	60°	5°	30°	60°	5°	30°	60°
3.0	7.3														
3.5	7.3														
4.0	7.3														
4.5	7.3														
5.0	7.3	7.3		7.3											
6.0	7.3	7.3		7.3											
7.0	7.3	7.3		7.3											
8.0	7.3	7.3	4.9	7.3	7.3		6.5								
9.0	7.3	7.2	4.8	7.3	7.3		6.5								
10.0	7.3	6.9	4.7	7.3	7.3	5.0	6.5								
11.0	7.3	6.6	4.7	7.3	7.3	4.9	6.5	6.5		3.7					
12.0	7.3	6.3		7.3	7.3	4.9	6.5	6.5		3.7					
14.0	6.4	5.9		7.3	7.3	4.8	6.5	6.5	4.9	3.7	3.7		3.2		
16.0	5.7	5.6		7.3	7.2	4.7	6.5	6.2	4.8	3.7	3.7	3.7	3.2	3.2	
18.0	5.1			7.3	6.9	4.7	6.5	5.9	4.8	3.7	3.7	3.7	3.2	3.2	3.2
20.0				7.3	6.6	4.7	6.3	5.6	4.7	3.7	3.7	3.7	3.2	3.2	3.2
22.0				7.3	6.3	4.7	5.8	5.4	4.7	3.7	3.7	3.7	3.2	3.2	3.2
24.0				7.0	6.1		5.3	5.2	4.6	3.7	3.7	3.7	3.2	3.1	3.0
26.0				6.4	5.9		4.9	5.0	4.6	3.7	3.7	3.7	3.0	2.9	2.9
28.0				5.5	5.7		4.5	4.5	4.6	3.7	3.6	3.5	2.8	2.8	2.7
30.0				4.7	4.9		4.2	4.0	3.9	3.4	3.4	3.3	2.7	2.6	2.6
32.0				3.9	4.1		3.8	3.8		3.1	3.2	3.1	2.5	2.5	2.4
34.0				3.5			3.2	3.4		2.5	2.9	3.0	2.3	2.3	2.3
36.0				2.7			3.1	2.9		2.0	2.3	2.5	1.8	2.2	2.2
38.0							2.6	2.8		1.5	1.8	2.0	1.4	1.7	1.8
40.0							2.2	2.3		1.1	1.4		1.0	1.3	1.4
42.0							1.8	1.9			1.0			0.9	
44.0							1.4	1.5							
46.0							1.1	1.2							

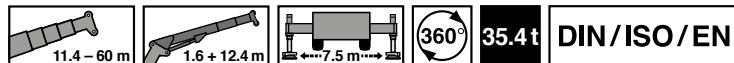

m	11.4 m + 1.6 m + 12.4 m			30.0 m + 1.6 m + 12.4 m			44.9 m + 1.6 m + 12.4 m			56.0 m + 1.6 m + 12.4 m			60.0 m + 1.6 m + 12.4 m		
	5°	30°	60°	5°	30°	60°	5°	30°	60°	5°	30°	60°	5°	30°	60°
3.0	7.3														
3.5	7.3														
4.0	7.3														
4.5	7.3														
5.0	7.3														
6.0	7.3			6.0											
7.0	7.3			6.0											
8.0	6.9	4.6		6.0											
9.0	6.4	4.4		6.0			4.0								
10.0	5.9	4.2		6.0			4.0								
11.0	5.5	3.9		6.0	4.3		4.0								
12.0	5.1	3.8	2.7	6.0	4.2		4.0			2.6					
14.0	4.4	3.5	2.6	6.0	3.9	2.7	4.0	3.8		2.6			2.4		
16.0	3.8	3.2	2.5	5.6	3.7	2.6	4.0	3.7		2.6			2.4		
18.0	3.4	3.0		5.2	3.5	2.6	4.0	3.5	2.6	2.6	2.6		2.4		
20.0	3.0	2.9		4.8	3.4	2.5	4.0	3.4	2.6	2.6	2.6		2.4	2.4	
22.0	2.7			4.5	3.2	2.5	4.0	3.2	2.5	2.6	2.6	2.5	2.4	2.4	2.4
24.0				4.2	3.1	2.5	4.0	3.1	2.5	2.6	2.6	2.5	2.4	2.4	2.4
26.0				3.9	3.0	2.5	4.0	3.0	2.5	2.6	2.6	2.5	2.4	2.4	2.4
28.0				3.7	2.9		4.0	2.9	2.5	2.6	2.6	2.5	2.4	2.4	2.4
30.0				3.5	2.8		3.8	2.9	2.4	2.6	2.6	2.5	2.4	2.4	2.4
32.0				3.4	2.8		3.6	2.8	2.4	2.6	2.6	2.4	2.3	2.2	2.2
34.0				3.2	2.7		3.5	2.7	2.4	2.6	2.6	2.4	2.2	2.1	2.1
36.0				3.0	2.7		3.2	2.6	2.4	2.6	2.5	2.4	2.1	2.0	2.0
38.0				2.8	2.7		3.0	2.6		2.5	2.4	2.4	2.0	1.9	1.9
40.0				2.7			2.9	2.5		2.4	2.3	2.3	1.9	1.8	1.8
42.0							2.8	2.5		2.2	2.2	2.2	1.8	1.7	1.7
44.0							2.6	2.4		2.0	2.1		1.7	1.7	1.7
46.0							2.5	2.4		1.9	2.0		1.6	1.6	
48.0							2.1	2.3		1.7	1.8		1.5	1.5	
50.0							1.9	2.0		1.4	1.6		1.3	1.4	
52.0										1.1	1.3		1.0	1.2	
54.0								1.7			1.0			0.9	

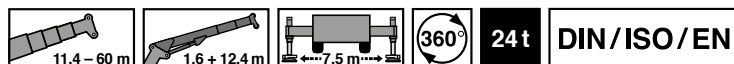

m	11.4 m + 1.6 m + 12.4 m			30.0 m + 1.6 m + 12.4 m			44.9 m + 1.6 m + 12.4 m			56.0 m + 1.6 m + 12.4 m			60.0 m + 1.6 m + 12.4 m		
	5°	30°	60°	5°	30°	60°	5°	30°	60°	5°	30°	60°	5°	30°	60°
3.0	7.3														
3.5	7.3														
4.0	7.3														
4.5	7.3														
5.0	7.3														
6.0	7.3			6.0											
7.0	7.3			6.0											
8.0	6.9	4.6		6.0											
9.0	6.4	4.4		6.0			4.0								
10.0	5.9	4.2		6.0			4.0								
11.0	5.5	3.9		6.0	4.3		4.0								
12.0	5.1	3.8	2.7	6.0	4.2		4.0			2.6					
14.0	4.4	3.5	2.6	6.0	3.9	2.7	4.0	3.8		2.6			2.4		
16.0	3.8	3.2	2.5	5.6	3.7	2.6	4.0	3.7		2.6			2.4		
18.0	3.4	3.0		5.2	3.5	2.6	4.0	3.5	2.6	2.6	2.6		2.4		
20.0	3.0	2.9		4.8	3.4	2.5	4.0	3.4	2.6	2.6	2.6		2.4	2.4	
22.0	2.7			4.5	3.2	2.5	4.0	3.2	2.5	2.6	2.6	2.5	2.4	2.4	2.4
24.0				4.2	3.1	2.5	4.0	3.1	2.5	2.6	2.6	2.5	2.4	2.4	2.4
26.0				3.9	3.0	2.5	4.0	3.0	2.5	2.6	2.6	2.5	2.4	2.4	2.4
28.0				3.7	2.9		4.0	2.9	2.5	2.6	2.6	2.5	2.4	2.4	2.4
30.0				3.5	2.8		3.8	2.9	2.4	2.6	2.6	2.5	2.4	2.4	2.4
32.0				3.3	2.8		3.3	2.8	2.4	2.6	2.6	2.4	2.3	2.2	2.2
34.0				3.2	2.7		3.3	2.7	2.4	2.6	2.6	2.4	2.2	2.1	2.1
36.0				3.0	2.7		3.1	2.6	2.4	2.5	2.5	2.4	2.1	2.0	2.0
38.0				2.8	2.6		2.6	2.5		2.0	2.4	2.4	1.9	1.9	1.9
40.0				2.5			2.5	2.5		1.6	2.1	2.3	1.5	1.8	1.8
42.0							2.3	2.3		1.2	1.7	1.9	1.1	1.5	1.7
44.0							1.9	2.1		0.9	1.3			1.2	1.4
46.0							1.6	1.8			0.9				
48.0							1.3	1.4							
50.0							1.0	1.1							

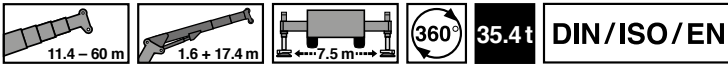

m	11.4 m + 1.6 m + 17.4 m			30.0 m + 1.6 m + 17.4 m			44.9 m + 1.6 m + 17.4 m			56.0 m + 1.6 m + 17.4 m			60.0 m + 1.6 m + 17.4 m		
	5°	30°	60°	5°	30°	60°	5°	30°	60°	5°	30°	60°	5°	30°	60°
4.0	3.3														
4.5	3.3														
5.0	3.3														
6.0	3.3														
7.0	3.3			3.2											
8.0	3.3			3.2											
9.0	3.3			3.2											
10.0	3.3			3.2			2.4								
11.0	3.3	2.6		3.2			2.4								
12.0	3.2	2.5		3.2			2.4								
14.0	2.9	2.3		3.2	2.4		2.4			1.8					
16.0	2.6	2.1	1.7	3.2	2.3		2.4			1.8			1.6		
18.0	2.4	2.0	1.7	3.1	2.2		2.4	2.1		1.8			1.6		
20.0	2.2	1.8	1.6	2.9	2.1	1.7	2.4	2.0		1.8	1.8		1.6		
22.0	2.0	1.7		2.7	2.0	1.6	2.4	2.0	1.6	1.8	1.8		1.6	1.6	
24.0	1.9	1.7		2.5	1.9	1.6	2.4	1.9	1.6	1.8	1.8		1.6	1.6	
26.0	1.8	1.6		2.4	1.8	1.6	2.4	1.8	1.6	1.8	1.8	1.5	1.6	1.6	1.5
28.0	1.6			2.3	1.8	1.6	2.4	1.8	1.6	1.8	1.7	1.5	1.6	1.6	1.5
30.0				2.2	1.7	1.6	2.3	1.7	1.5	1.8	1.7	1.5	1.6	1.6	1.5
32.0				2.1	1.6	1.5	2.2	1.7	1.5	1.8	1.6	1.5	1.6	1.6	1.4
34.0				2.0	1.6		2.1	1.6	1.5	1.8	1.6	1.4	1.6	1.6	1.4
36.0				1.9	1.6		2.0	1.6	1.5	1.8	1.5	1.4	1.6	1.5	1.4
38.0				1.8	1.5		2.0	1.5	1.5	1.8	1.5	1.4	1.6	1.5	1.4
40.0				1.8	1.5		1.9	1.5	1.5	1.8	1.5	1.4	1.6	1.5	1.4
42.0				1.7	1.5		1.8	1.5		1.8	1.4	1.4	1.6	1.4	1.4
44.0				1.7			1.8	1.5		1.8	1.4	1.4	1.6	1.4	1.3
46.0				1.6			1.7	1.4		1.7	1.4	1.4	1.5	1.4	1.3
48.0							1.7	1.4		1.7	1.4	1.4	1.4	1.3	1.3
50.0							1.6	1.4		1.6	1.3		1.4	1.3	1.3
52.0								1.4		1.5	1.3		1.3	1.3	
54.0								1.4		1.2	1.3		1.1	1.2	
56.0								1.4		0.9	1.3			1.2	
58.0											1.0			0.9	

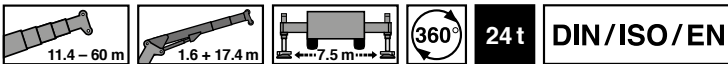

m	11.4 m + 1.6 m + 17.4 m			30.0 m + 1.6 m + 17.4 m			44.9 m + 1.6 m + 17.4 m			56.0 m + 1.6 m + 17.4 m			60.0 m + 1.6 m + 17.4 m		
	5°	30°	60°	5°	30°	60°	5°	30°	60°	5°	30°	60°	5°	30°	60°
4.0	3.3														
4.5	3.3														
5.0	3.3														
6.0	3.3														
7.0	3.3			3.2											
8.0	3.3			3.2											
9.0	3.3			3.2											
10.0	3.3			3.2			2.4								
11.0	3.3	2.6		3.2			2.4								
12.0	3.2	2.5		3.2			2.4								
14.0	2.9	2.3		3.2	2.4		2.4			1.8					
16.0	2.6	2.1	1.7	3.2	2.3		2.4			1.8			1.6		
18.0	2.4	2.0	1.7	3.1	2.2		2.4	2.1		1.8			1.6		
20.0	2.2	1.8	1.6	2.9	2.1	1.7	2.4	2.0		1.8	1.8		1.6		
22.0	2.0	1.7		2.7	2.0	1.6	2.4	2.0	1.6	1.8	1.8		1.6	1.6	
24.0	1.9	1.7		2.5	1.9	1.6	2.4	1.9	1.6	1.8	1.8		1.6	1.6	
26.0	1.8	1.6		2.4	1.8	1.6	2.4	1.8	1.6	1.8	1.8	1.5	1.6	1.6	1.5
28.0	1.6			2.3	1.8	1.6	2.4	1.8	1.6	1.8	1.7	1.5	1.6	1.6	1.5
30.0				2.2	1.7	1.6	2.3	1.7	1.5	1.8	1.7	1.5	1.6	1.6	1.5
32.0				2.1	1.6	1.5	2.2	1.7	1.5	1.8	1.6	1.5	1.6	1.6	1.4
34.0				2.0	1.6		2.1	1.6	1.5	1.8	1.6	1.4	1.6	1.6	1.4
36.0				1.9	1.6		2.0	1.6	1.5	1.8	1.5	1.4	1.6	1.5	1.4
38.0				1.8	1.5		2.0	1.5	1.5	1.8	1.5	1.4	1.6	1.5	1.4
40.0				1.8	1.5		1.9	1.5	1.5	1.8	1.5	1.4	1.6	1.5	1.4
42.0				1.7	1.5		1.8	1.5		1.7	1.4	1.4	1.5	1.4	1.4
44.0				1.7			1.7	1.5		1.3	1.4	1.4	1.2	1.4	1.3
46.0				1.6			1.7	1.4		1.0	1.4	1.4	0.9	1.4	1.3
48.0							1.6	1.4			1.2	1.4		1.1	1.3
50.0							1.4	1.4			0.9				1.0
52.0								1.4							
54.0								1.1							

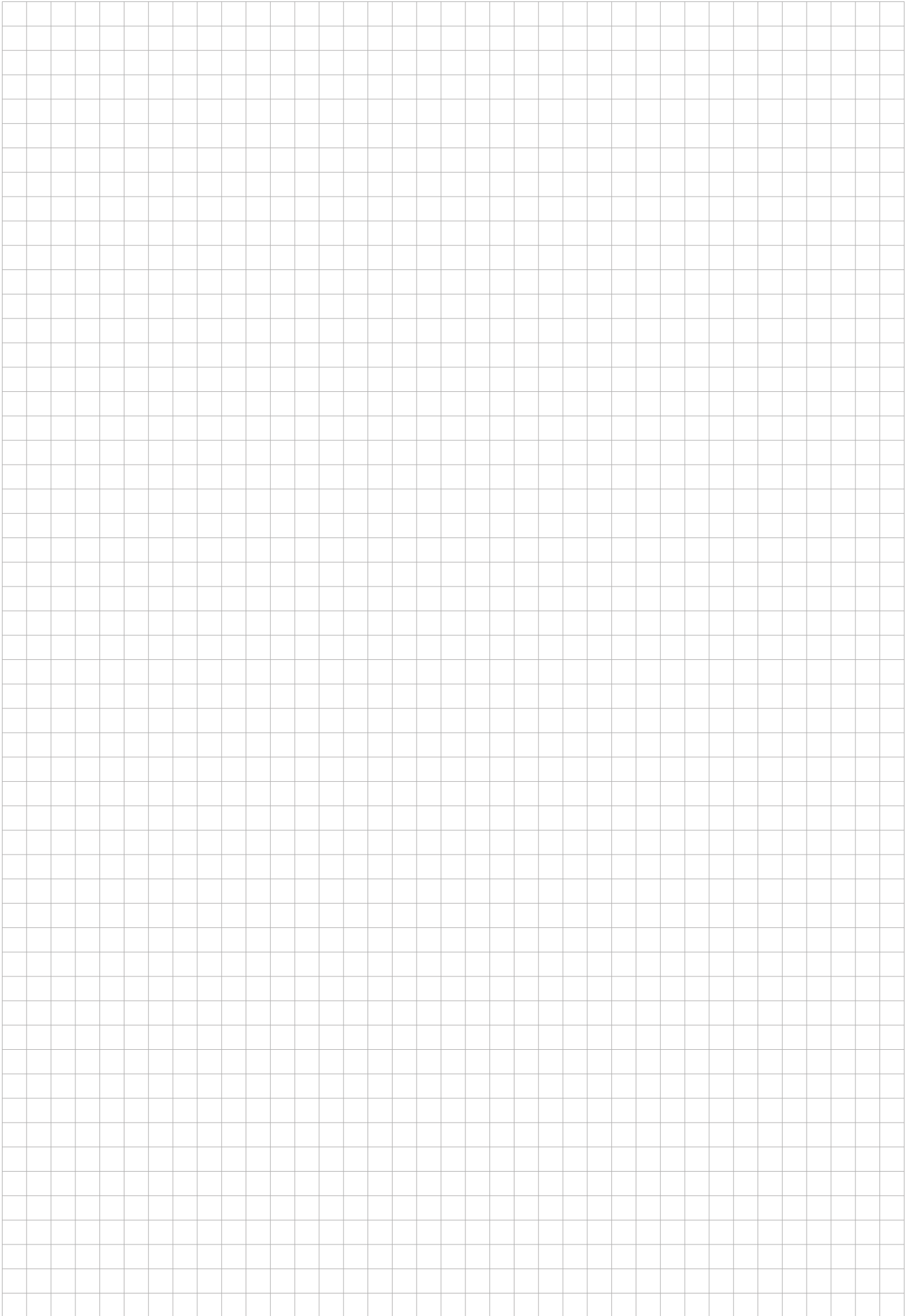

EQUIPMENT

AUSSTATTUNG

ÉQUIPEMENT

EQUIPAMIENTO

EQUIPAGGIAMENTO

ОБОРУДОВАНИЕ



Equipment

Carrier

Frame: Torsion-resistant, welded construction made from high strength, fine-grained steel. Central lubrication system.

Outriggers: 4-point double telescopic hydraulic outriggers incl. asymmetric outrigger base and automatic length detection. Controls on both sides of carrier and in superstructure cab. Outrigger base 7.5 m (6.2 m / 5.0 m / 4.1 m / 2.5 m) x 8.03 m.

Engine: Mercedes-Benz 6 cylinder model OM 471 LA (Euromot V / EPA Tier 4f), water-cooled diesel engine. Engine displacement 10.7 l. Rated at 390 kW (530 HP) at 1600 rpm. Torque 2600 Nm at 1300 rpm. Engine rating according to ECE R120. Fuel tank: 600 l. AdBlue tank: 40 l.

Transmission: Main transmission: mechanical ZF-TraXon 12.1 transmission, with integrated intarder, electro-pneumatically actuated dry clutch and fully automatic transmission control system. 12 forward gears and 2 reverse gears. If necessary, semi-automatic mode (Tip-Tronic) is possible with manual gear selection.

Transfer case: Two-stage.

Drive: 10 x 6

Axes:

1st axle: steered, not driven.

2nd axle: steered, driven, with differential lock, longitudinal and transverse.

3rd axle: steered, not driven.

4th axle: steered, driven, with differential lock, longitudinal and transverse.

5th axle: steered, driven, with differential lock, transverse.

Suspension: Hydro-pneumatic with levelling adjustment.

Brake system: Service disk brakes: dual circuit compressed air system with electronic wear indicator. Parking brake: spring loaded type acting on 2nd, 4th and 5th axles. Intarder and engine brake as retarder.

Tyres: (10) 445/95 R 25 (16.00 R 25).

Steering system: ZF-Servocom, dual circuit hydraulic steering with emergency steering pump, mechanical steering of 1st and 2nd axles and automatic steering of the 3rd and 4th axle up to a travel speed of 25 km/h, and of the 5th axle up to 50 km/h.

Carrier cab: Two man full width cab of composite (steel sheet metal and fibre-glass) structure, with safety glass, central locking system, air-cushioned seats, driver's seat offering various adjustment options, with memory function and heater, engine dependent water heater, air conditioning, Bluetooth hands-free equipment, multifunction display, rear view camera, radio/CD player with USB port, control and operating elements for driving operation, cruise control and hill braking feature.

Electrical system: 24 V DC, 2 batteries, CAN bus system with integrated CSS system for self-diagnosis, outrigger area lighting. The electrical system is compliant with the ECE directive.

Optional equipment: (at extra charge)

Towing attachment, engine independent additional heater with engine pre-heat, drive 10 x 8, ABS system, 525/80 R 25 (20.5 R 25) tyres, spare wheel and tyre, special painting and lettering. Further optional equipment available upon request.

Superstructure

Frame: Torsion-resistant, all-welded structure. Connected to carrier by single-row, ball-bearing slewing ring with external gearing for 360° continuous rotation. Central lubrication system.

Engine: Mercedes-Benz 4 cylinder model OM 934 LA (Euromot V / EPA Tier 4f), water cooled diesel engine. Variable speed via foot pedal. Engine displacement 5.1 l. Rated at 129 kW (175 HP) at 1800 rpm. Torque 750 Nm at 1200 - 1600 rpm. Engine rating according to ECE R120. Fuel tank: 230 l. AdBlue tank: 25 l.

Hydraulic system: Three-circuit diesel-hydraulic system, 1 power-controlled axial piston twin pump (electro-hydraulically adjustable), 1 axial piston pump control and 1 gear pump, oil cooler.

Controls: Two 4-fold electrical joy-stick levers with electrical pilot control.

Telescopic boom: 6 sections, made of high tensile, fine-grained steel, consisting of 1 base section and 5 telescoping sections extended by means of a single telescopic cylinder. All telescope sections extendable hydraulically under partial load. 11.4 m to 60.0 m long. Boom head with 6 sheaves.

Boom elevation: 1 double acting hydraulic cylinder with integral brake and holding valve.

Main winch: Axial piston variable displacement motor, winch drum with integrated planetary reduction and hydraulically controlled spring-loaded multiple disc brake and integrated free rotation (no sagging of load when hoisting), drum turn indicator. Hoist cable with 'Super-Stop' system.

Slewing system: Axial piston constant motor, three-stage planetary gear with service and parking brake. Open hydraulic circuit with free slewing function. Speed infinitely variable from 0 to 2 rpm.

Counterweight: Total 35.4 t divisible. Controlled from superstructure cab.

Superstructure cab: Spacious crane cab in steel / plastic design with safety glass windows and tinted panes, tilting working place with adjustable, mechanically cushioned driver's seat with heating, autonomous auxiliary heater with engine pre-heating, air conditioning, radio/CD player, control and operating elements for crane operation, outrigger actuation and carrier engine features.

Electrical system: 24 V DC, 2 batteries.

Safety devices: 'Lift Adjuster', electronic load moment limiter (LMB) with pilot lamp in several colours, slewing area and working area limitation with 'Slow-Stop' feature, hoist limit switch, lower limit switch, safety valves protect against pipe and hose failures.

Optional equipment: (at extra charge)

Jib 0.9 m + 2.6 m to 0.9 m + 30.8 m, offsets 0°, 22°, and 45°, or hydraulically 0°- 45°, HTLJ jib 1.6 m + 7.4 m to 1.6 m + 17.4 m (hydraulically tiltable and telescopable 5° to 60°), 10 t hook tackle, hook blocks from 32 t to 160 t, 2nd hoisting winch, auxiliary oil cooler, special paint and lettering. Further optional equipment available upon request.

Unterwagen

Rahmen: Verwindungs- und biegesteife Schweißkonstruktion aus hochfestem Feinkornstahl. Zentralschmieranlage.

Abstützung: Hydraulische 4-Punkt-Doppelteleskopabstützung inkl. asymmetrischer Abstützbasis und automatischer Längenerkennung, Bedienungsmöglichkeiten an beiden Seiten des Fahrgestelles und in der Oberwagenkabine. Abstützbasis 7,5 m (6,2 m / 5,0 m / 4,1 m / 2,5 m) x 8,03 m.

Motor: Mercedes-Benz 6-Zylinder-Dieselmotor OM 471 LA (Euromot V / EPA Tier 4f), wassergekühlt, Hubraum 10,7 l, Leistung 390 kW (530 PS) bei 1600 min⁻¹. Drehmoment 2600 Nm bei 1300 min⁻¹. Motorleistung nach ECE R120. Kraftstoffbehälter: 600 l. AdBlue-Behälter: 40 l.

Getriebe: Hauptgetriebe ZF-TraXon 12.1, mechanisches Schaltgetriebe mit integriertem Intarder, elektronisch-pneumatisch betätigter Trockenkupplung und vollautomatischer Schaltung mit 12 Vorwärts- und 2 Rückwärtsgängen. Bei Bedarf teilautomatischer Betrieb (Tip-Tronic) mit manueller Gangwahl möglich.

Verteilergetriebe: 2-stufiges Verteilergetriebe.

Antrieb: 10 x 6

Achsen:

1. Achse: gelenkt, nicht angetrieben.
2. Achse: gelenkt, angetrieben, Differentialsperre längs und quer.
3. Achse: gelenkt, nicht angetrieben.
4. Achse: gelenkt, angetrieben, Differentialsperre längs und quer.
5. Achse: gelenkt, angetrieben, Differentialsperre quer.

Achsanhängung: Hydropneumatische Federung mit Niveauregulierung.

Bremsen: Zweikreis-Druckluft-Scheibenbremsanlage mit elektrischer Verschleißanzeige und Lufttrockner. Feststellbremse als Federspeicherbremse an der 2., 4. und 5. Achse wirkend. Intarder und Motorbremse als Dauerbremse.

Räder: 10-fach 445/95 R 25 (16.00 R 25).

Lenkung: ZF-Servocom-Zweikreishydraulenlenkung mit Notlenkpumpe. Mechanische Lenkung der 1. und 2. Achse und Mitlenken der 3. und 4. Achse bis zu einer Geschwindigkeit von 25 km/h und der 5. Achse bis zu 50 km/h.

Unterwagenkabine: Zwei-Mann-Frontfahrerhaus in Stahl-Kunststoff-Verbund-Konstruktion, Sicherheitsverglasung, Zentralverriegelung, luftgefederte Sitze, Fahrersitz vielseitig einstellbar mit Memoryfunktion und beheizbar, motorabhängige Wasserheizung, Klimaanlage, Bluetooth Freisprecheinrichtung, Multifunktionsdisplay, Rückfahrkamera, Radio/CD-Player mit USB Anschluss, Kontroll- und Bedienungselemente für den Fahrbetrieb, Tempomat- / Bremsomat-Funktion.

Elektrische Anlage: 24 Volt-Gleichstrom, 2 Batterien, CAN-Bus System mit integriertem CSS-System zur Eigendiagnose, Abstützfeldbeleuchtung. Die elektrische Anlage entspricht der ECE-Richtlinie.

Zusatzrüstung: (gegen Mehrpreis)

Anhängerkupplung, motorunabhängige Zusatzheizung mit Motorvorwärmung, 10 x 8 Antrieb, ABS, 525/80 R 25 (20.5 R 25) Bereifung, Reserverad, Sonderlackierung und Beschriftung. Weitere Zusatzrüstung auf Anfrage.

Oberwagen

Rahmen: Verwindungssteife Schweißkonstruktion mit einer außenverzahnten, einreihigen Kugeldrehverbindung, um 360° unbegrenzt drehbar. Zentralschmieranlage.

Motor: Mercedes-Benz 4-Zylinder-Dieselmotor OM 934 LA (Euromot V / EPA Tier 4f), wassergekühlt. Drehzahl ist über Fußpedal stufenlos regelbar, Hubraum 5,1 l, Leistung 129 kW (175 PS) bei 1800 min⁻¹. Drehmoment 750 Nm bei 1200 - 1600 min⁻¹. Motorleistung nach ECE R120. Kraftstoffbehälter: 230 l. AdBlue-Behälter: 25 l.

Hydraulik System: Diesel-hydraulisch mit 3-Kreis-Hydraulik, 1 leistungsgeregelte Axialkolbendoppelpumpe (elektrohydraulisch verstellbar), 1 Axialkolbenpumpe und 1 Zahnradpumpe, Ölkühler.

Steuerung: Zwei 4-fach Kreuzsteuerhebel mit elektrischer Vorsteuerung.

Teleskopausleger: Sechsteiliger Teleskopausleger aus hochfestem Feinkornstahl, bestehend aus einem Grundausleger und 5 Teleskopteilen, 1 Teleskopzylinder, hydraulisch unter Teillast teleskopierbar. 11,4 m - 60,0 m lang. Rollenkopf mit 6 Seilrollen.

Wippwerk: Ein Differentialzylinder mit angebautem Senkbremssperrventil.

Hubwerk: Axialkolben-Verstell-Motor, Hubwerkstrommel mit eingebautem Planetengetriebe und federbelasteter Hydro-Lamellenbremse mit integriertem Freilauf beim Heben. Seilwindendrehmelder. Hubseil mit 'Super-Stop' Einrichtung.

Drehwerk: Axialkolben-Konstant-Motor, dreistufiges Planetengetriebe mit Feststellbremse. Offener Hydraulikkreislauf mit Drehwerk-Freischaltung. Drehgeschwindigkeit stufenlos von 0 - 2 min⁻¹.

Gegengewicht: Gesamtgewicht 35,4 t, teilbar. Die Bedienung erfolgt aus der Oberwagenkabine.

Oberwagenkabine: Großräumige Krankabine in Stahl-Kunststoffausführung mit Sicherheitsverglasung und getönten Scheiben, kippbarem Arbeitsplatz mit verstellbarem, mechanisch gedämpftem Fahrersitz mit Heizung, motorunabhängige Zusatzheizung mit Motorvorwärmung, Klimaanlage, Radio / CD-Player, Kontroll- und Bedienungselemente für Kranbetrieb. Betätigung der Abstützung und Motorfunktionen des Unterwagens.

Elektrische Anlage: 24 Volt-Gleichstrom, 2 Batterien.

Sicherheitseinrichtungen: 'Lift Adjuster', Elektronische Lastmomentbegrenzung (LMB) mit Ampelkennleuchte, Dreh- und Arbeitsbereichsbegrenzung mit 'Slow-Stop' Funktion, Hubendechalter, Windenendechalter, Sicherheitsventile gegen Rohr- und Schlauchbrüche.

Zusatzrüstung: (gegen Mehrpreis)

Auslegerverlängerung 0,9 m + 2,6 m bis 0,9 m + 30,8 m, wahlweise abwinkelbar 0°, 22° und 45° oder hydraulisch 0°- 45°, Auslegerverlängerung HTLJ 1,6 m + 7,4 m bis 1,6 m + 17,4 m (hydraulisch abwinkel- und teleskopierbar 5° - 60°), 10 t Hakengeschirr, Unterflaschen von 32 t bis 160 t, 2. Hubwinde, Zusatzölkühler, Sonderlackierung und Beschriftung, Stützkraftanzeige. Weitere Zusatzrüstung auf Anfrage.

Équipement

Châssis

Châssis: Construction mécano-soudée, en acier à grain fin très rigide, résistant aux flexions et aux torsion. Graissage centralisé.

Calage: Dispositif de calage horizontal et vertical double en 4 points, entièrement déployable hydrauliquement, y compris distance entre appuis asymétrique, détection de longueur automatique et commande des mouvements sur les deux côtés du porteur et depuis la cabine de la superstructure. Calage 7,5 m (6,2 m / 5,0 m / 4,1 m / 2,5 m) x 8,03 m.

Moteur: Mercedes-Benz diesel 6 cylindres modèle OM 471 LA (Euromot V / EPA Tier 4f), refroidi par eau, cylindrée 10,7 l, de 390 kW (530 CV) à 1 600 min⁻¹. Couple 2600 Nm à 1300 min⁻¹. Puissance selon ECE R120. Capacité du réservoir: 600 l. Capacité du réservoir AdBlue: 40 l.

Boîte de vitesse: Boîte principale ZF-TraXon 12.1, boîte de vitesses mécanique avec intarder intégré, embrayage à sec électro-pneumatique et commande des vitesses complètement automatique avec 12 vitesses AV et 2 vitesses AR. Si nécessaire, mode partiellement automatique (Tip-Tronic) avec sélection de vitesses manuelle possible.

Boîte de transfert: à deux gammes.

Entraînement: 10 x 6

Essieux:

1^{er} essieu: directeur, non entraîné.

2^{ème} essieu: directeur, entraîné, blocage de différentiel longitudinal et transversal.

3^{ème} essieu: directeur, non entraîné.

4^{ème} essieu: directeur, entraîné, blocage de différentiel longitudinal et transversal.

5^{ème} essieu: directeur, entraîné, blocage de différentiel transversal.

Suspension: Hydro-pneumatique, avec réglage de niveau.

Freins: Système de freinage à disque à air comprimé, à deux circuits, avec indicateur d'usure électronique et déshumidificateur. Frein de stationnement, agit sur les essieux 2, 4 et 5 comme frein à ressorts accumulateurs. Intarder et frein moteur comme frein continu.

Pneus: 10 x 445/95 R 25 (16.00 R 25).

Direction: Servocom à double circuit, marque ZF avec pompe de secours pour direction. Direction mécanique du 1^{er} et 2^{ème} essieu, direction à assistance hydraulique du 3^{ème} et 4^{ème} essieu jusqu'à une vitesse de 25 km/h et du 5^{ème} essieu jusqu'à 50 km/h.

Cabine: Cabine bi-place, construction en matière combinée (acier/matière plastique), vitres en verre de sécurité, système de verrouillage central, sièges à suspension pneumatique, siège du conducteur à plusieurs réglages, avec fonction de mémoire et chauffant, chauffage d'eau alimenté par le moteur, climatiseur, dispositif mains libres Bluetooth, affichage multi-fonctions, caméra de recul, radio / CD-player avec connecteur USB, éléments de contrôle et de commande pour la conduite, régulateur de vitesse, système automatique de freinage.

Système électrique: 24 V CC, 2 batteries, système du bus CAN avec système CSS intégré pour l'autodiagnostic, allumage de la zone d'appui. Le système électrique satisfait à la directive ECE.

Équipement supplémentaire: (avec supplément de prix) Attache-remorque, chauffage auxiliaire indépendant du moteur avec préchauffage du moteur, entraînement 10 x 8, système ABS, pneus 525/80 R 25 (20.5 R 25), roue de secours, peinture spéciale et inscription. Autres équipements supplémentaires sur demande.

Superstructure

Plate forme: Construction mécano-soudée résistante à la torsion. Couronne d'orientation à billes à une rangée, à denture extérieure, permettant une rotation illimitée sur 360°. Graissage centralisé.

Moteur: Mercedes-Benz diesel 4 cylindres, modèle OM 934 LA (Euromot V / EPA Tier 4f), refroidi par eau. Réglage en continu du nombre de tours par pédale, cylindrée 5,1 l, de 129 kW (175 CV) à 1800 min⁻¹. Couple 750 Nm à 1200 - 1600 min⁻¹. Puissance selon ECE R120. Capacité du réservoir: 230 l. Capacité du réservoir AdBlue: 25 l.

Système hydraulique: Diesel-hydraulique à 3 circuits, 1 double pompe à piston axial réglée en fonction de la puissance (à réglage électro-hydraulique), 1 pompe à piston axial et 1 pompe à engrenages, refroidisseur d'huile.

Commande: 2 manipulateurs à commande en croix (4 sens), assistés électriquement.

Flèche télescopique: Flèche télescopique à 6 éléments en acier à texture fine et très résistant, se composant de 1 éche de base et 5 éléments télescopiques, 1 vérin télescopique, hydrauliquement télescopable avec charge partielle. Longueur de 11,4 m à 60,0 m. Tête de flèche avec 6 poulies.

Mécanisme de relevage: 1 vérin différentiel muni de clapet de freinage de descente.

Mécanisme de levage: Moteur à pistons axiaux, tambour de levage avec boîte planétaire incorporée, frein d'arrêt à disques multiples à ressort libéré lors du levage. Indicateur de rotation du treuil. Câble de levage avec dispositif 'Super-Stop'.

Groupe de rotation: Moteur à cylindrée constante à pistons axiaux, avec engrenage planétaire à trois étages avec frein d'arrêt. Circuit hydraulique ouvert avec déconnexion du groupe de rotation. Vitesse de rotation 0 à 2 min⁻¹ en continu.

Contrepoids: Poids total 35,4 t divisible, commandé depuis la cabine du grutier.

Cabine du grutier: Cabine de grue spacieuse, construction en acier/plastique, vitrage de sécurité en verre teinté, place de travail inclinable avec siège du conducteur réglable, amorti mécaniquement, chauffant, chauffage d'appoint autonome avec préchauffage du moteur, climatiseur, radio / CD-player, éléments de commande et de contrôle pour le service de grue. Actionnement des outriggers et fonctions du moteur dans le châssis.

Système électrique: 24 V CC, 2 batteries.

Dispositifs de sécurité: 'Lift Adjuster', contrôleur de l'état de charge (CEC) électronique avec lampe de signalisation, limitation de rotation et limitation de la zone de travail avec fonction 'Slow-Stop', interrupteur de fin de course de levage et de treuil, soupapes de sécurité contre ruptures des conduites et exibles.

Équipement supplémentaire: (avec supplément de prix) Rallonge de flèche 0,9 m + 2,6 m à 0,9 m + 30,8 m, au choix inclinable 0°, 22° et 45° ou hydrauliquement 0° à 45°, rallonge de flèche HTLJ 1,6 m + 7,4 m à 1,6 m + 17,4 m (inclinable et télescopable hydrauliquement de 5° à 60°), crochet de levage 10 t, moufles inférieurs de 32 t à 160 t, 2^{ème} treuil de levage, refroidisseur d'huile d'appoint, peinture spéciale et inscription, affichage des forces d'appui. Autres équipements supplémentaires sur demande.

Chasis

Bastidor: Construcción de acero de grano fino de alta resistencia soldado, resistente a la torsión y a la exión. Sistema de lubricación centralizada.

Estabilización: Sistema de 4 puntos, estabilizadores telescópicos hidráulicos dobles, incl. base de apoyo asimétrica y detección automática de longitud, posibilidad de manejo desde ambos lados del chasis y desde la cabina de la grúa. Base de apoyo 7,5 m (6,2 m / 5,0 m / 4,1 m / 2,5 m) x 8,03 m.

Motor: Motor diesel Mercedes Benz, modelo OM 471 LA (Euromot V / EPA Tier 4f), 6 cilindros, refrigerado por agua. Cilindrada 10,7 l. Potencia nominal 390 kW (530 CV) a 1600 rpm. Par 2600 Nm a 1300 rpm. Potencia del motor según ECE R120. Depósito de combustible: 600 l. Depósito de AdBlue: 40 l.

Transmisión: Transmisión principal mecánica del tipo ZF-TraXon 12.1 con intarder integrado, con embrague en seco accionado de modo electro-neumático y cambio automático de 12 marchas hacia delante y 2 marchas atrás. En caso necesario, operación semiautomática (Tip-Tronic) con selección manual de las marchas.

Divisor de fuerza: Divisor de fuerza de 2 escalones.

Tracción: 10 x 6

Ejes:

- Eje 1: de dirección, no accionado.
- Eje 2: de dirección, accionado, con bloqueo de diferencial longitudinal y transversal.
- Eje 3: de dirección, no accionado.
- Eje 4: de dirección, accionado, con bloqueo de diferencial longitudinal y transversal.
- Eje 5: de dirección, accionado, con bloqueo de diferencial transversal.

Suspensión de los ejes: Suspensión hidroneumática con regulación de nivel.

Frenos: Sistema de frenos de disco neumático de doble circuito con indicador de desgaste eléctrico y secador de aire. Freno de estacionamiento como freno de muelle de efecto en los ejes 2, 4 y 5. Intarder y freno de motor como freno continuo.

Neumáticos: 10 x 445/95 R 25 (16.00 R 25).

Dirección: Dirección hidráulica de doble circuito ZF-Servo-com. Bomba de emergencia de dirección. Dirección mecánica de los ejes 1 y 2, y dirección automática de los ejes 3 y 4 hasta una velocidad de 25 km/h y del eje 5 hasta 50 km/h.

Cabina del chasis: Cabina de conductor frontal para dos personas construida en material compuesto de chapa de acero y plástico, acristalamiento de seguridad, bloqueo central, asientos neumáticos, asiento del conductor regulable en múltiples posiciones con función memoria y calentable, calefacción por agua dependiente del motor, aire acondicionado, dispositivo manos libres vía Bluetooth, pantalla multifuncional, cámara de marcha atrás, radio/reproductor CD con puerto USB, elementos de control y mando para el funcionamiento de traslación, limitador automático de velocidad y función de frenado automático en bajadas.

Sistema eléctrico: 24 voltios de corriente continua, 2 baterías, sistema de bus CAN con sistema CSS integrado para autodiagnóstico, iluminación de la zona de la estabilización. El sistema eléctrico está conforme con la directiva ECE.

Equipamiento adicional: (con cargos adicionales) Enganche de remolque, calefacción adicional independiente del motor con calentamiento previo del motor, tracción 10 x 8, ABS, neumáticos 525/80 R 25 (20.5 R 25), rueda de repuesto, pintura especial y rotulación. Otros equipamientos adicionales bajo solicitud.

Superestructura

Bastidor: Construcción de acero soldado resistente a la torsión. Corona de giro con rodamiento de una hilera de bolas, con dientes externos, para giro continuo a 360°. Sistema de lubricación centralizada.

Motor: Motor diesel Mercedes Benz, modelo OM 934 LA (Euromot V / EPA Tier 4f), 4 cilindros, refrigerado por agua. Regulación continua del régimen a través del pedal. Cilindrada 5,1 l. Potencia nominal 129 kW (175 CV) a 1800 rpm. Par de 750 Nm a 1200 - 1600 rpm. Potencia del motor según ECE R120. Depósito de combustible: 230 l. Depósito de AdBlue: 25 l.

Sistema hidráulico: Dieselhidráulico con sistema hidráulico de 3 circuitos, 1 bomba doble de pistones axiales de caudal variable (regulable electro-hidráulicamente), 1 bomba de pistones axiales y 1 bomba de engranajes, enfriador de aceite.

Controles: Dos palancas de mando tipo joystick cuádruple con mando piloto eléctrico.

Pluma telescópica: Pluma telescópica de seis secciones de acero de grano fino de alta resistencia, compuesta de una pluma base y 5 secciones de telescopio, 1 cilindro de telescopio, extensible y retraible de modo hidráulico bajo carga parcial. Longitud de 11,4 m a 60,0 m. Cabezal de poleas con 6 poleas.

Mecanismo de basculado: Un cilindro de doble efecto con válvula de frenado de descenso.

Cabrestante principal: Motor de pistones axiales de cilindrada variable, tambor del cabrestante con engranaje planetario incorporado y freno hidráulico de discos con marcha libre para elevar integrada. Avisador de giro del cabrestante. Cable de elevación con dispositivo 'Super-Stop'.

Sistema de giro: Motor de pistones axiales de cilindrada constante, engranaje planetario de tres etapas con freno de estacionamiento. Circuito hidráulico abierto con dispositivo de liberación del sistema de giro. Velocidad de giro variable de modo continuo de 0 a 2 rpm.

Contrapeso: Peso total 35,4 t, divisible. El manejo se realizará desde la cabina de la grúa.

Cabina de la grúa: Amplia cabina de grúa construida en chapa de acero y plástico, acristalamiento de seguridad coloreado, puesto de trabajo inclinable con asiento de conductor regulable, amortiguado mecánicamente con calefacción, calefacción adicional independiente del motor con calentamiento previo del motor, aire acondicionado, radio / reproductor CD, elementos de control y mando para el funcionamiento de grúa. Actuación de la estabilización y funciones del motor del chasis.

Sistema eléctrico: 24 voltios de corriente continua, 2 baterías.

Dispositivos de seguridad: 'Lift Adjuster', limitador del momento de carga electrónico con señalización por semáforo, limitación de giro y de la zona de trabajo con función de parada lenta, interruptor de fin de carrera de elevación, interruptor de fin de carrera del cabestrante, válvulas de seguridad contra roturas de tubos y mangueras.

Equipamiento adicional: (con cargos adicionales) Prolongación de la pluma 0,9 m + 2,6 m a 0,9 m + 30,8 m, opcionalmente con ángulos de 0°, 22° y 45° o, de modo hidráulico, 0° a 45°, prolongación de la pluma HTLJ 1,6 m + 7,4 m a 1,6 m + 17,4 m (cambio del ángulo y accionamiento de telescopios de modo hidráulico 5° a 60°), aparejo de gancho de 10 t, ganchos de 32 t a 160 t, 2° cabrestante, enfriador de aceite adicional, pintura especial y rotulación, indicador de fuerza de apoyo. Otros equipamientos adicionales bajo solicitud.

Equipaggiamento

Carro

Telaio: Struttura saldata resistente a sollecitazioni a torsione e fessione in acciaio a grano fine ad alta resistenza. Impianto di lubrificazione centrale.

Stabilizzazione: Stabilizzazione telescopica doppia su 4 punti, di tipo idraulico, incl. base di appoggio asimmetrica, rilevamento automatico lunghezza, possibilità di comando dai due lati del telaio e dalla cabina della sovrastruttura. Base di appoggio 7,5 m (6,2 m / 5,0 m / 4,1 m / 2,5 m) x 8,03 m.

Motore: Motore Diesel a 6 cilindri Mercedes-Benz OM 471 LA (Euromot V / EPA Tier 4f), raffreddato ad acqua, cilindrata 10,7 l, potenza 390 kW (530 PS) a 1600 min⁻¹. Coppia 2600 Nm a 1300 min⁻¹. Potenza motore conforme a ECE R120. Serbatoio carburante: 600 l. Serbatoio AdBlue: 40 l.

Cambio: Trasmissione principale ZF-TraXon 12.1 con Intarder integrato, frizione a secco ad azionamento elettro-pneumatico e innesto marce automatico, con 12 marce avanti e 2 retromarce. Opzionale: funzionamento parzialmente automatico (Tiptronic) con selezione marce manuale.

Gruppo di rinvio: Gruppo di rinvio a 2 stadi.

Trasmissione: 10 x 6

Assi:

1° asse: snodato, non asse motore.

2° asse: snodato, asse motore, bloccaggio differenziale longitudinale e trasversale.

3° asse: snodato, non asse motore.

4° asse: snodato, asse motore, bloccaggio differenziale longitudinale e trasversale.

5° asse: snodato, asse motore, bloccaggio differenziale trasversale.

Sospensione assiale: Sospensione idro-pneumatica con regolazione di livello.

Freni: Impianto ad aria compressa per freno a doppio circuito e a disco con indicazione usura elettronica ed essiccatore di aria. Freno di stazionamento con funzione di freno a molla a rilascio pneumatico sul 2°, 4° e 5° asse. Intarder e freno motore come freno continuo.

Ruote: 10x 445/95 R 25 (16.00 R 25).

Sterzo: Sistema idroguida a doppio circuito ZF Servocom con pompa sterzo di emergenza. Sterzata meccanica del 1° e 2° asse e attivazione sul 3° e 4° asse fino a una velocità di 25 km/h e sul 5° asse fino a 50 km/h.

Cabina del carro: Cabina conducente frontale per due in struttura composita acciaio-plastica, vetratura di sicurezza, chiusura centralizzata, sedili molleggiati, sedile conducente impostabile in vari modi con funzione memory e riscaldamento, riscaldamento acqua dipendente dal motore, climatizzatore, vivavoce Bluetooth, display multifunzione, telecamera retromarcia, radio/lettore CD con collegamento USB, elementi di controllo e comando per la marcia e funzioni Tempomat e Bremsomat.

Impianto elettrico: Corrente continua 24 Volt, 2 batterie, sistema CAN Bus con sistema CSS integrato per autodiagnosi, illuminazione zona di stabilizzazione. L'impianto elettrico è conforme alle norme ECE.

Equipaggiamento aggiuntivo: (a sovrapprezzo)

Gancio di traino, riscaldamento supplementare indipendente dal motore con preriscaldamento motore, trasmissione 10 x 8, ABS, pneumatici 525/80 R 25 (20.5 R 25), ruota di scorta, verniciatura speciale e diciture. Altro equipaggiamento aggiuntivo su richiesta.

Sovrastruttura

Telaio: Struttura saldata resistente alla torsione con corona di rotazione a sfere ad una fila, dentata esternamente, ruotabile di 360° senza limitazioni. Impianto di lubrificazione centrale.

Motore: Motore Diesel a 4 cilindri Mercedes-Benz OM 934 LA (Euromot V / EPA Tier 4f), raffreddato ad acqua. Regolazione continua numero di giri da pedale, cilindrata 5,1 l, potenza 129 kW (175 PS) a 1800 min⁻¹. Coppia 750 Nm a 1200 - 1600 min⁻¹. Potenza motore conforme a ECE R120. Serbatoio carburante: 230 l. Serbatoio AdBlue: 25 l.

Impianto idraulico: Diesel-idraulico con idraulica a 3 circuiti, 1 pompa doppia a pistoni assiali con regolazione di potenza (regolazione elettroidraulica), 1 pompa a pistoni assiali e 1 pompa a ingranaggi, radiatore olio.

Comando: Due leve di comando gru x4 con precomando elettrico.

Braccio telescopico: Braccio telescopico in sei sezioni in acciaio a grano fine ad alta resistenza, composto da un braccio base e 5 sezioni telescopiche, 1 cilindro telescopico, funzione telescopica ad azionamento idraulico sotto carico parziale. Lunghezza 11,4 m - 60,0 m. Testa rullo con 6 pulegge.

Gruppo di brandeggio: Un cilindro differenziale con valvola di non ritorno freno integrata.

Meccanismo di sollevamento: Servomotore a pistone assiale, tamburo del meccanismo di sollevamento con rotismo epicicloidale incorporato e freno a disco idraulico sollecitato a molla con ruota libera integrata nel sollevamento. Indicatore delle rotazioni dei verricelli. Funne di sollevamento con dispositivo 'Super-Stop'.

Gruppo di rotazione: Motore costante a pistoni assiali, ingranaggio epicicloidale a tre stadi con freno di stazionamento. Circuito idraulico aperto con attivazione gruppo di rotazione. Velocità di rotazione regolabile in continuo da 0 a 2 min⁻¹.

Contrappeso: Peso complessivo 35,4 t divisibile. L'azionamento si effettua dalla cabina.

Cabina della sovrastruttura: Spaziosa cabina della gru in acciaio-plastica con vetratura di sicurezza e cristalli oscurati, postazione di lavoro ribaltabile con sedile conducente regolabile, con molleggio meccanico e riscaldamento, riscaldamento supplementare indipendente dal motore con preriscaldamento motore, climatizzatore, radio/lettore CD, elementi di controllo e comando per esercizio gru. Azionamento della stabilizzazione e funzioni motore del carro.

Impianto elettrico: Corrente continua 24 Volt, 2 batterie.

Dispositivi di sicurezza: 'Lift Adjuster', limitatore del momento di carico (LMC) elettronico con luce di riferimento a semaforo, delimitazione dell'area di rotazione e delimitazione dell'area di lavoro con funzione Slow-Stop, interruttore di fine corsa, fine corsa argani, valvole di sicurezza contro rottura tubi e tubi fessibili.

Equipaggiamento aggiuntivo: (a sovrapprezzo)

Prolunga del braccio 0,9 m + 2,6 m fino a 0,9 m + 30,8 m, a scelta con regolazione angolo a 0°, 22° e 45° o idraulica 0° - 45°, prolunga del braccio HTLJ 1,6 m + 7,4 m fino a 1,6 m + 17,4 m (con angolazione e funzione telescopica a comando idraulico 5° - 60°), gancio di blocco da 10 t, bozzelli da 32 t fino a 160 t, 2° argano di sollevamento, radiatore olio supplementare, verniciatura speciale e diciture, capacità di appoggio. Altro equipaggiamento aggiuntivo su richiesta.

Ходовая платформа

Рама: Жесткая на скручивание и изгиб сварная конструкция из высокопрочной мелкозернистой стали. Централизованная смазочная система.

Аутригеры: Гидравлическая опора в четырех точках, включая поддержку асимметричной базы аутригеров и автоматическое распознавание положения стрелы, возможность управления с обеих сторон ходовой части и из кабины на поворотной платформе.
Опорная база 7,5 м (6,2 м / 5,0 м / 4,1 м / 2,5 м) x 8,03 м.

Двигатель: 6-цилиндровый дизельный двигатель Mercedes-Benz OM 471 LA (Euromot V / EPA Tier 4f), с водяным охлаждением, рабочий объем двигателя 10,7 л, мощность 390 кВт (530 л. с.) при 1600 об/мин. Крутящий момент 2 600 Н·м при 1 300 об/мин. Мощность двигателя согласно ECE R120. Топливный бак: 600 л.
Бак для присадки AdBlue: 40 л.

Коробка передач: Главный редуктор ZF-TraXon 12.1, механическая коробка передач со встроенным интардером, электронно-пневматическим управлением сухим дисковым сцеплением и полностью автоматическим переключением 12 передач переднего и 2 передач заднего хода. При необходимости возможен полуавтоматический режим (Tip-Tronic) с переключением передач вручную.

Раздаточная коробка: 2-ступенчатая раздаточная коробка.

Привод: 10 x 6

Оси:

- 1-я ось: управляемая, неприводная.
- 2-я ось: управляемая, приводная, с продольной и поперечной блокировкой межколёсного дифференциала.
- 3-я ось: управляемая, неприводная.
- 4-я ось: управляемая, приводная, с продольной и поперечной блокировкой межколёсного дифференциала.
- 5-я ось: управляемая, приводная, с поперечной блокировкой межколёсного дифференциала.

Подвеска оси: Гидропневматическая подвеска с регулировкой уровня.

Тормоза: Пневматическая двухмагистральная дисковая тормозная система с электронным индикатором износа и осушителем воздуха. Стояночный тормоз, представляющий собой тормозной механизм с пружинным энергоаккумулятором, воздействует на 2-ю, 4-ю и 5-ю оси. Интардер и моторный тормоз в качестве постоянного тормоза.

Колеса: 10-ные 445/95 R 25 (16.00 R 25).

Рулевое управление: Двухконтурное гидравлическое рулевое управление ZF-Servocom с резервным насосом рулевого управления. Механическое рулевое управление 1-й и 2-й осями и автоматическое подруливание 3-й и 4-й осью при скорости до 25 км/ч и 5-й осью – до 50 км/ч.

Кабина ходовой платформы: Двухместная передняя кабина водителя композитной конструкции (металлический лист и стекловолокно), безосколочное стекло, центральный замок, сиденья с пневматической подвеской, сиденье водителя регулируемое по многим параметрам, с функцией памяти и подогревом), водяной отопитель, зависящий от работы двигателя, кондиционер, спикерфон с функцией Bluetooth, многофункциональный дисплей, камера заднего вида, радиоприемник / CD-плеер с портом USB, элементы управления и индикации для ходового режима, функция темпомата / автоматического торможения.

Система электрооборудования: 24 вольт пост. тока, 2 аккумуляторные батареи, система шины CAN со встроенной системой CSS для самодиагностики, подсветка аутригеров. Электрооборудование отвечает стандарту EC.

Дополнительное оборудование: (за надбавку к цене) Тягово-сцепное устройство, независимый от работы двигателя дополнительный отопитель с подогревом двигателя, привод 10 x 8, ABS, шины 525/80 R 25 (20.5 R 25), запасное колесо, специальное лаковое покрытие и нанесение надписей. Другое дополнительное оборудование – по запросу.

Оборудование

Поворотная платформа

Рама: Жёсткая на скручивание сварная конструкция с однорядным сферическим поворотным соединением с внешними зубьями, с неограниченным поворотом на 360°. Централизованная смазочная система.

Двигатель: 4-цилиндровый дизельный двигатель Mercedes-Benz OM 934 LA, (Euromot V / EPA Tier 4f), с водяным охлаждением. Бесступенчатая регулировка оборотов посредством педали, рабочий объем двигателя 5,1 л, мощность 129 кВт (175 л. с.) при 1800 об/мин. Крутящий момент 750 Н·м при 1 200 – 1 600 об/мин. Мощность двигателя согласно ECE R120. Топливный бак: 230 л. Бак для присадки AdBlue: 25 л.

Гидравлическая система: Дизельно-гидравлическая с 3-контурным гидроагрегатом, 1 аксиально-поршневой насос двойного действия (с электрогидравлической регулировкой), 1 аксиально-поршневой насос одинарного действия и 1 шестеренный насос, масляный радиатор.

Система управления: Два 4-сторонних крестовых рычага управления краном с предварительным электрическим регулированием.

Телескопическая стрела: Шестисекционная телескопическая стрела из высокопрочной мелкозернистой стали, включает основную секцию стрелы и 5 телескопических секций, 1 телескопический цилиндр, выдвигается гидравлическим способом по мере создания нагрузки. Длина 11,4 м – 60,0 м. Роликовая обойма с 6-ю канатными шкивами.

Механизм изменения подъема стрелы: Дифференциальный цилиндр со смонтированным на нем запорным клапаном спускного тормоза.

Подъемный механизм: Аксиально-поршневой двигатель с переменным рабочим объемом, барабан подъемного механизма с встроенным планетарным редуктором и пружинным гидравлическим многодисковым тормозом с встроенным механизмом свободного хода при подъеме. Сигнализатор вращения барабана лебедки. Подъемный трос с тормозным приспособлением 'Super-Stop'.

Поворотный механизм: Аксиально-поршневой двигатель с постоянным рабочим объемом, трехступенчатый планетарный редуктор со стояночным тормозом. Гидравлический контур, работающий по разомкнутой схеме, со схемой включения поворотного механизма. Бесступенчатое изменение скорости вращения, 0 – 2 об/мин.

Противовес: Общий вес 35,4 т, составной. Управление осуществляется из кабины на поворотной платформе.

Кабина на поворотной платформе: Просторная кабина крана композитной конструкции (металл и пластик), остекление тонированным безосколочным стеклом, откидное рабочее место с регулируемым по высоте сиденьем водителя с механическим амортизатором и подогревом, независимый от работы двигателя дополнительный отопитель с подогревом двигателя, кондиционер, радио / CD-плеер, элементы управления и индикации для режима работы крана. Управление выдвиганием аутригеров и перемещением крана по рабочей площадке.

Система электрооборудования: 24 вольт пост. тока, 2 аккумуляторные батареи.

Устройства безопасности: Регулятор подъема 'Lift Adjuster', электронный ограничитель момента нагрузки (LMB) с подачей опознавательных световых сигналов, ограничитель зоны поворота и рабочей зоны с функцией медленной остановки 'Slow-Stop', концевой выключатель лебедки, клапаны безопасности на случай повреждения гидравлических трубок и шлангов.

Дополнительное оборудование: (за надбавку к цене) Удлинитель стрелы от 0,9 м + 2,6 м до 0,9 м + 30,8 м, изменение угла наклона по выбору 0°, 22° и 45° либо гидравлическим способом 0–45°, удлинитель стрелы HTLJ от 1,6 м + 7,4 м до 1,6 м + 17,4 м (гидравлическое изменение угла и телескопирование 5–60°), крюковая подвеска 10 т, крюковые обоймы от 32 до 160 т, 2-я подъемная лебедка, дополнительный масляный охладитель, специальное лаковое покрытие и нанесение надписей, индикатор опорного усилия. Другое дополнительное оборудование – по запросу.

ADDITIONAL INFORMATION

ZUSATZINFORMATIONEN
INFORMATIONS SUPPLÉMENTAIRES
INFORMACIÓN ADICIONAL
ALTRE INFORMAZIONI
ДОПОЛНИТЕЛЬНАЯ ИНФОРМАЦИЯ



Additional information · Zusatzinformationen · Informations supplémentaires

Remarks relating to the capacity charts · Anmerkungen zu den Traglasttabellen Remarques relatives aux tableaux des charges

1. The lifting capacities in the structural area are based on EN 13000.
2. The lifting capacities in the stability area are based on ISO 4305 / EN 13000.
3. Depending on the boom length, max. wind speeds between 7 m/s and 15 m/s are permissible in the lifting capacity charts.
4. Due to different extending sequences of the telescopes, the boom lengths indicated in the lifting capacity charts may deviate slightly.
5. The lifting capacities are shown in metric tons.
6. The weight of load handling devices such as hook blocks, slings, etc., must be considered as part of the load and must be deducted from the lifting capacities.
7. The lifting capacities for the telescopic boom apply to a crane with no jib being stowed or mounted on the crane.
8. The load radius is the horizontal distance from the centre of the slewing ring to the centre of gravity of a suspended, non-oscillating load.

1. Die Tragfähigkeiten im Festigkeitsbereich basieren auf EN 13000.
2. Die Tragfähigkeiten im Standsicherheitsbereich entsprechen ISO 4305 / EN 13000.
3. In Abhängigkeit der Auslegerlänge sind bei den Traglasttabellen max. Windgeschwindigkeiten zwischen 7 m/s und 15 m/s zulässig.
4. Aufgrund unterschiedlicher Ausfahrfolgen der Teleskope können die in den Traglasttabellen angegebenen Auslegerlängen geringfügig abweichend sein.
5. Die Tragfähigkeiten sind in metrischen Tonnen angegeben.
6. Das Gewicht des Lasthakens bzw. der Unterflasche und weiterer Anschlagmittel ist von der Tragfähigkeit abzuziehen.
7. Die Tragfähigkeiten für den Teleskopausleger gelten nur bei demontierter Auslegerverlängerung.
8. Die Ausladung ist der horizontale Abstand von Mitte Drehkranz bis zum Schwerpunkt freihängender, nicht schwingender Last.

1. Les forces de levage sont conformes aux normes EN 13000.
2. Les forces de levage dans la partie de stabilité au renversement sont conformes aux normes ISO 4305 / EN 13000.
3. Des vitesses de vent max. entre 7 et 15 m/s sont autorisées pour les tableaux des charges en fonction de la longueur de la flèche.
4. Les longueurs de flèche indiquées dans les tableaux des charges peuvent être légèrement divergentes en raison des différentes séries de déploiement des télescopes.
5. Les forces de levage sont données en tonnes métriques.
6. Le poids du crochet-moufle et de tous les accessoires d'élingage font partie de la charge et sont à déduire des charges indiquées.
7. Les forces de levage indiquées pour la flèche télescopique s'entendent rallonge de flèche déposée.
8. La portée est la distance horizontale du milieu de la couronne d'orientation au centre de gravité de la charge suspendue librement sans osciller.

General remarks · Allgemeine Anmerkungen · Remarques générales

Unless otherwise specified, all the information given in this brochure refers to the standard equipment of the crane and only is intended as general information. For correct crane operation, the original operating manual and lifting capacity charts are essential. No liability is accepted for the accuracy of this information. Errors and omissions excepted. Illustrations are similar only. All dimensions - unless otherwise specified - in mm.

Alle Angaben in dieser Broschüre beziehen sich - wenn nicht anderweitig aufgeführt - auf die Standard-Ausstattung des Krans und dienen nur zur allgemeinen Information. Zum ordnungsgemäßen Betrieb des Krans sind die original Bedienungsanleitung und Traglasttabellen maßgeblich. Alle Angaben erfolgen ohne Gewähr. Änderungen und Irrtümer vorbehalten. Abbildungen ähnlich. Alle Bemaßungen - wenn nicht anders angegeben - in mm.

Sauf indication contraire, toutes les informations dans cette brochure se rapportent à l'équipement standard de la grue et constituent uniquement des informations générales. Pour le fonctionnement correct de la grue, le manuel d'instructions original et les tableaux des charges de levage sont déterminants. Toutes les informations sont fournies sans garantie. Sous réserve de modifications techniques et d'erreurs. Illustrations similaires mais pas identiques à l'engin montré. Toutes les cotes - sauf indication différente - en mm.

Notas relativas a los graficos de carga · Annotazioni sulle tabelle delle portate Примечания к таблицам грузоподъемности

1. En cuanto a los datos referentes a resistencia, las capacidades de carga están basados sobre las normas EN 13000.
2. En cuanto a los datos referentes a estabilidad anti-vuelco, las capacidades de carga están basados sobre las normas ISO 4305 / EN 13000.
3. En función de la longitud de la pluma, son admisibles velocidades máx. del viento entre 7 m/s y 15 m/s en las tablas de cargas.
4. Debido a las diferentes secuencias de extensión de los telescopios, es posible que las longitudes de la pluma indicadas en las tablas de cargas sean ligeramente distintas.
5. Las capacidades de carga indicadas en las tablas corresponden a toneladas métricas.
6. Hay que deducir los pesos del gancho, eslingas y de otros dispositivos para fijación de cargas de los valores indicados en las tablas.
7. Las capacidades de carga referentes a la pluma telescópica valen solamente si el alargamiento de pluma está desmontado.
8. El alcance de pluma es la distancia horizontal del centro de la corona de giro al centro de gravedad de una carga suspendida que no está oscilando.

1. Le capacità di carico nel range di resistenza sono riferite alla norma EN 13000.
2. Le capacità di carico nel range di stabilità sono conformi alle norme ISO 4305 / EN 13000.
3. Nelle tabelle delle portate sono ammesse velocità del vento comprese tra 7 m/s e 15 m/s in funzione della lunghezza del braccio.
4. Considerata le diverse sequenze di sfilo dei telescopi, le lunghezze del braccio indicate nelle tabelle delle portate possono essere lievemente differenti.
5. Le capacità di carico sono indicate in tonnellate metriche.
6. Il peso del gancio di carico, ovvero del bozzello e delle altre imbracature deve essere detratto dalla capacità di carico.
7. Le capacità di carico per il braccio telescopico sono applicabili soltanto con prolunga del braccio smontata.
8. Per sbraccio si intende la distanza orizzontale dal centro della corona rotante al centro del carico sospeso, ma non oscillante.

1. Значения грузоподъемности в пределах категории прочности основаны на положениях стандарта EN 13000.
2. Значения грузоподъемности в пределах области устойчивости соответствуют стандарту ISO 4305 / EN 13000.
3. В зависимости от длины стрелы таблицы грузоподъемности допускают скорость ветра от 7 до 15 м/с.
4. Длина телескопической стрелы в выдвинутом состоянии может незначительно отличаться от указанной в таблицах грузоподъемности из-за различных последовательностей выдвигания.
5. Грузоподъемность указана в метрических тоннах.
6. Из грузоподъемности необходимо вычесть вес грузового крюка или крюковой обоймы, а также других грузозахватных приспособлений.
7. Значения грузоподъемности для телескопической стрелы действительны только при демонтированном удлинителе стрелы (гуське).
8. Вылет — это расстояние по горизонтали между центром поворотного круга и центром тяжести свободно подвешенного некачающегося груза.

Notas adicionales · Annotazioni generali · Общие примечания











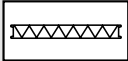

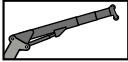
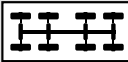















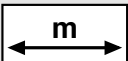

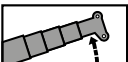
A no ser que se indique lo contrario, todos los datos incluidos en este folleto hacen referencia al equipamiento estándar de la grúa y sólo tienen un carácter informativo general. El manual de instrucciones original y las tablas de capacidades de carga son determinantes para lograr un correcto funcionamiento de la grúa. Todos los datos se facilitan sin garantía. Reservadas las modificaciones y los errores. Ilustraciones similares. Todas las dimensiones - salvo indicación en contrario - en mm.

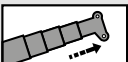
Se non diversamente specificato, tutti i dati di questa brochure si riferiscono alla dotazione standard della gru e sono da considerarsi come informazioni generali. Per un esercizio corretto della gru, sono determinanti il manuale d'uso originale e le tabelle delle portate. Si declina ogni responsabilità per tutti i dati. Con riserva di modifiche ed errori. Figure simili. Tutte le quotature sono in mm (se non diversamente specificato).

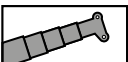
Все данные, приведенные в этой брошюре, относятся – если не указано иное – к стандартному оснащению крана и служат лишь для общей информации. Порядок надлежащей эксплуатации крана определяется оригиналом руководства по эксплуатации и таблицами грузоподъемности. Все данные приведены без обязательств. Возможны изменения и ошибки. Иллюстрации являются приблизительными. Все размеры – если не указано другое – в мм.

Symbols · Symbolerklärung · Glossaire des symboles

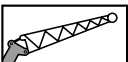
Glosario de simbolos · Spiegazione dei simboli · Условные обозначения

	Gross weight · Gesamtgewicht Poids total · Peso total Peso totale · Полная масса		Fly jib section · Spitzenteil Élément de fléchette · Plumín Parte punta · Головная секция
	Axle load · Achslast Charge à l'essieu · Carga por eje Carico assiale · Осевая нагрузка		Hydraulic telescopic and luffing jib HTLJ · Hydraulische Teleskop- und Wippspitze HTLJ · Fléchette télescopique relevable hydrauliquement HTLJ · Plumín hidráulicamente telescópico y regulable HTLJ Punta oscilante e telescópica idráulica HTLJ · Телескопическая секция и оголовок с гидравлическим приводом HTLJ
	Drive · Antrieb Entraînement · Tracción Trazione · Привод		Swing area · Drehbereich Rayon de rotation · Zona de giro Area di rotazione · Область поворота
	Tyres · Bereifung Pneus · Neumáticos Pneumatici · Шины		Hydraulically lockable · Hydraulisch verriegelbar Verrouillable hydrauliquement · Con embulonamiento hidráulico · Con dispositivo di bloccaggio idraulico Гидравлическая блокировка
	Gradeability · Steigfähigkeit · Capacité de gravissement de pente · Superación de pendientes · Capacità di salita Способность преодолевать подъем		Main winch · Hubwinde · Mécanisme de levage Cabrestante principal · Meccanismo di sollevamento Главная лебедка
	Off road / On road · Gelände / Straße Tout-terrain / Mode "Route" · Todo terreno / En carretera Fuori strada / Su strada · Бездорожье / Дорога		Auxiliary winch · Zusatzhubwinde Treuil supplémentaire · Cabrestante auxiliar Argano aggiuntivo · Дополнительная лебедка
	Speed · Geschwindigkeit Vitesse · Velocidad Velocità · Скорость		Type · Typ Tipo · Тип
	Outriggers · Abstützung Calage · Estabilizadores Stabilizzazione · На аутригерах		Lifting capacity · Traglast Charge de levage · Carga Portata · Грузоподъемность
	Counterweight · Gegengewicht Contrepoids · Contrapeso Contrappeso · Противовес		Rope sheaves · Seilrollen Poules de câbles · Poleas de cable Pulegge · Канатные шкивы
	Counterweight element · Gegengewichtselement Élément de contrepoids · Parte del contrapeso Parte contrappeso · Деталь противовеса		Parts of line · Seilstränge Brins de câble · Ramales de cable Spire della fune · Запасовка
	Length · Länge Longueur · Longitud Lunghezza · Длина		Dead-weight · Eigengewicht Poids total · Tara Peso proprio · Собственный вес
	Boom elevation · Wippwerk · Mécanisme de relevage Elevación de pluma · Gruppo di brandeggio Механизм изменения подъема стрелы		Wire rope length · Hubseillänge Longueur du câble de levage · Longitud del cable de izaje · Lunghezza fune di sollevamento Длина подъемного троса
	Boom telescoping · Teleskopieren Télescopage de flèche · Telescopaje de pluma Telescopaggio · Телескопирование		Wire rope diameter · Hubseildurchmesser Diamètre du câble de levage · Diámetro del cable de elevación · Diametro fune di sollevamento Диаметр подъемного троса
	Telescopic boom · Teleskopausleger Flèche télescopique · Pluma telescópica Braccio telescopico · Телескопическая стрела		Wire rope pulling force · Hubseilzugkraft Force de traction du câble de levage · Fuerza de tracción del cable de elevación · Forza di trazione fune di sollevamento · Тяговое усилие подъемного троса
	Radius · Ausladung Portée · Radio Sbraccio · Вылет		Weight · Gewicht Poids · Peso Peso · Bec
	Tilttable jib · abwinkelbare Spitze Fléchette inclinable · Plumín regulable Punta con regolazione angolo Гусек с изменением угла наклона		
	Hydraulically tilttable jib · hydraulisch abwinkelbare Spitze Fléchette inclinable hydrauliquement · Plumín regulable hidráulicamente · Punta con regolazione angolo idraulica Гусек гидравлический с изменением угла наклона		

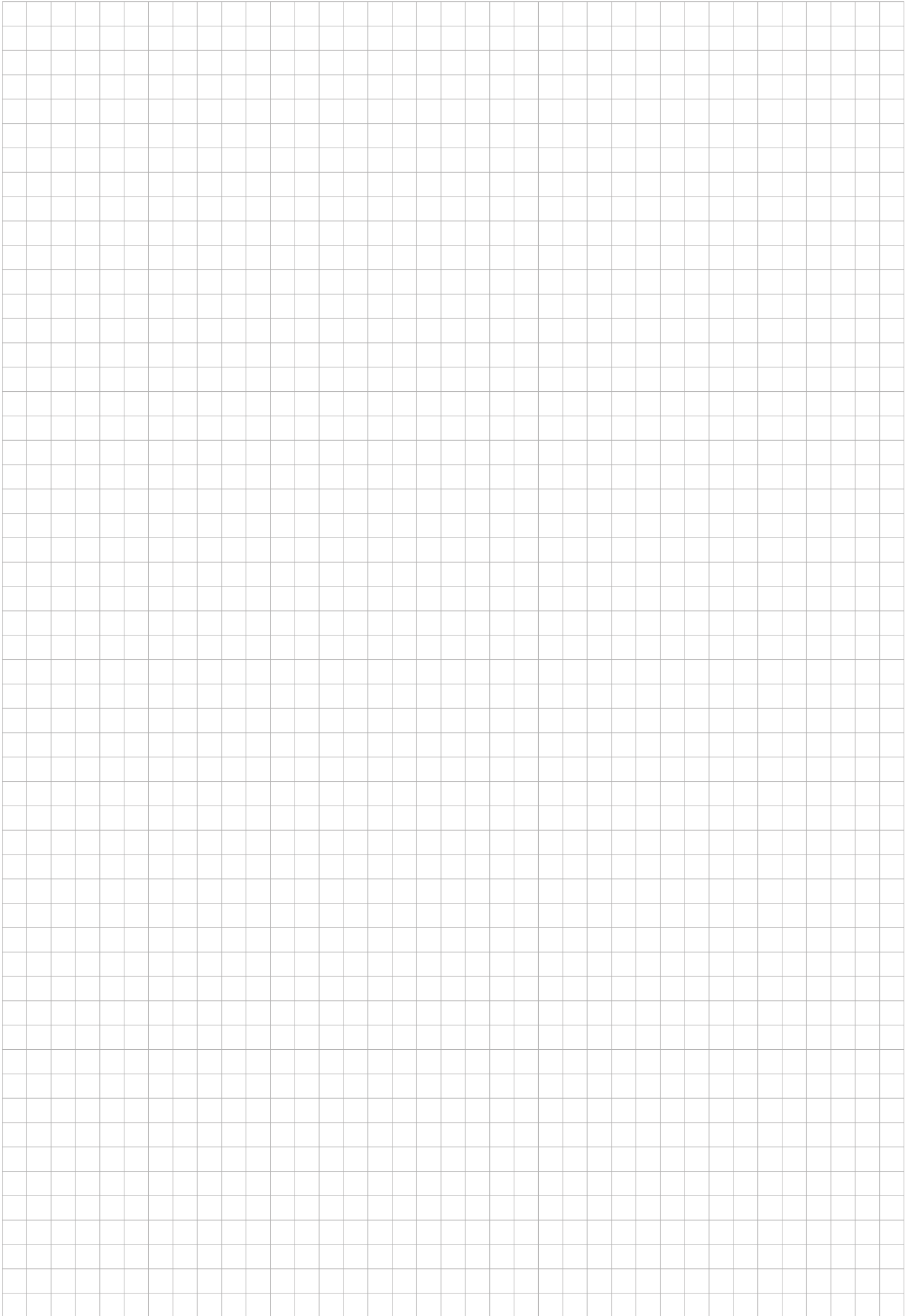



You can find your **direct TADANO contact person** on:
www.tadano.com/wwnetwork/



TADANO FAUN GmbH

Faunberg 2 · 91207 Lauf a. d. Pegnitz · Germany
Phone: +49-9123-185-0 · Fax: +49-9123-3085
www.tadanofaun.de · info@tadanofaun.de

TADANO LTD. (International Division)

4-12, Kamezawa 2-chome, Sumida-ku Tokyo 130-0014, Japan
Phone: 81-3-3621-7750 · Fax: 81-3-3621-7785
www.tadano.com · info@tadano.com